



€

# GÖTESSONS

FROM WORKPLACE TO CREATIVE SPACE™ 2025

WELCOME TO AN EVEN QUIETER ROOM WITHIN A ROOM



# CASA

FROM: GÖTESSONS

## CASA UNO

Welcome to an even quieter room within a room. Casa Uno is the phone booth designed for those who need extra concentration or need to make important phone calls that shouldn't be overheard. Inside, you'll find a fixed table for your computer, power outlets, charging ports, comfortable dimmable lighting, and an optional barstool. The booth is also equipped with automatic ventilation to ensure a pleasant and fresh environment.

Designed by o4i Design Studio.

Read more on page 64.

# 2025

## INDEX

Intro and Inspirational news	2-5
Textiles, Zips, Seams, Mounts	6-25
Desk screens, Desk screen booths	26-43
Toolbars, Rails, Screen accessories	44-53
Floor screens, Room dividers	54-61
Room-within-a-room	62-81
Whiteboards, Writing boards, Notice boards	82-93
Absorbents ceilings	94-117
Absorbents wall	118-137
Storage	138-145
Soft seating, Table	146-161
Ergonomic products, Floor protection	162-167
Plants, Pots, Baskets	168-191
Lighting	192-201
Monitor arms	202-207
Recycling, CPU holders, Cable holders, Cable collectors	208-225
Electrical accessories	226-237
By David design	238-269
Product register, Information, Delivery time	270-271



## **BY DAVID DESIGN** NOW AVAILABLE AT GÖTESSONS

Since 2020, Götessons has had David Design as a sister company, and many of you have probably met us at trade shows in Sweden and Europe where we exhibited together. In many ways, we have found synergies between the companies, not least because several of our key functions have collaborated in the same building at the headquarters in Ulricehamn.

From January 1, 2025, you will be able to purchase a large selection of David Design's best-selling products through our sales channels at Götessons. As a result, our comprehensive offering within Götessons Design Group is strengthened, and above all, it will become easier for you as a customer to order multiple brands from a single channel. The offering for you as a customer will simply become even better and clearer!

See more of our new brand on page 238.

## SOFA SANDY IN NEW SHAPES



### SANDY

The Sandy serie is expanding with new seating modules and accessories. For enhanced sitting comfort, a backrest is available that can be easily attached with two stable metal rods. The previously round poufs are now complemented by straight modules called Anex. Create unique combinations by connecting middle and outer sections. These modules can be placed either free-standing or with one edge against a wall. Design by JOOY Design Studio.

Read more on page 148.

### SANDY SOLUS

Sandy Solus is a freestanding seating furniture with two connected crescent-shaped seats and a central backrest. It's the perfect lounge solution for waiting rooms, entrances, and other public spaces.

Read more on page 149.



# WALL DECORATIONS AND ROOM DIVIDERS



## LINK

Link is a designed wire grid for ceiling/wall mounting that is added with Off the Grid absorbent in dressed or raw EcoSUND.

Read more on page 120 (wall) and 96 (ceiling).



## FLORA PANEL

Create a plant wall with the Flora panel, designed to match the size of our other wall panels. It features a dense arrangement of various artificial plants, creating the beautiful illusion of a green oasis.

Read more on page 170.

## DIVIDO IN NEW PATTERNS

Room divider Divido in molded felt give the room a lively feeling and screens open spaces. Consists of two panels that together form a neat pattern. We now launch three new patterns that we call Leaves, bubbles, circles.

Read more on page 106.



## CLAMP DESIGN

Clamp is a discreet and stylish suspension system for sound absorbers, designed to emphasize the material and maximize sound absorption.

Read more on page 121 (wall) and 97 (ceiling).

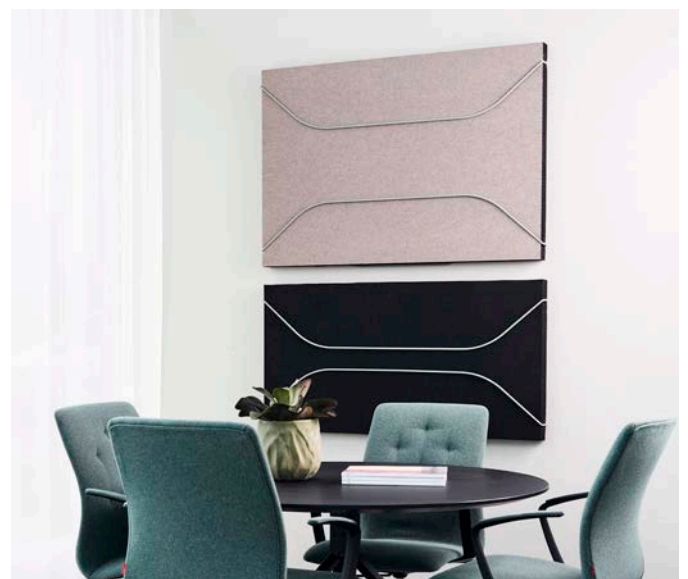



Textile suitable for screens and panels



Textile suitable for soft seating

Price class  
1

## TONAL BY GABRIEL

Post-consumer Recycled

TONAL-A CROSSFUNCTIONAL TEXTILE WITH AN EXCELLENT ENVIRONMENTAL PROFILE

With its discreet yet distinct look, good performance and excellent environmental profile, Tonal is a highly usable cross functional textile that is suitable for a variety of applications and interiors. Tonal is a two-coloured fabric in a playful yet harmonious melange. The fusion of Light and Dark tones adds depth and creates an almost three-dimensional effect. Tonals colour palette offers a mix of cold and warm colours, deep and bright hues.



Colour 120  
(2495-60122  
Light Grey)



Colour 121  
(2495-60123  
Light Grey)



Colour 122  
(2495-64211  
Dark Red)

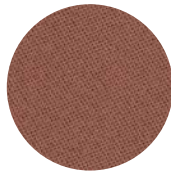

Colour 123  
(2495-64210  
Light Red)

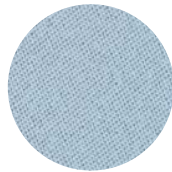

Colour 124  
(2495-66184  
Light Blue)

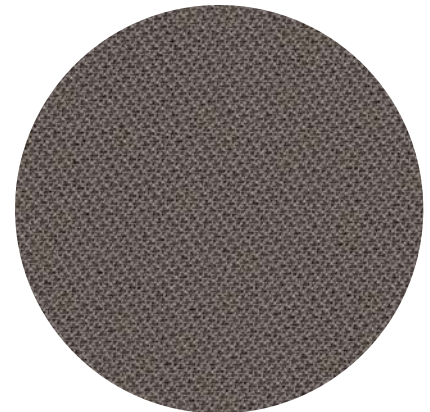

Colour 130  
(2495-61182  
Red Brown)

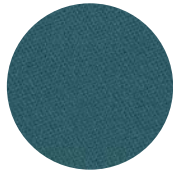

Colour 125  
(2495-66186  
Dark Blue)

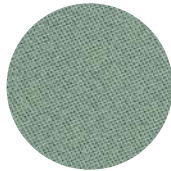

Colour 126  
(2495-67089  
Light Green turquoise)

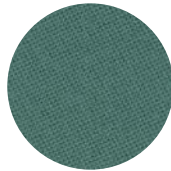

Colour 127  
(2495-67090  
Green Turquoise)

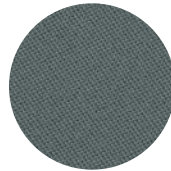

Colour 128  
(2495-60124  
Grey)



Colour 129  
(2495-61179  
Light Beige)

Price class  
1

## EVENT SCREEN + BY GABRIEL

EVENT SCREEN + – A VERSATILE, CROSS-FUNCTIONAL TEXTILE

Event Screen + is a versatile, cross-functional upholstery fabric made of 100% polyester. With its crispy look, distinct stony texture and fresh colour palette, Event Screen + is a confident and modern interpretation of the classic crepe fabric. Event Screen + fulfills the requirements for both vertical and horizontal surfaces, making it suitable for both screens and soft seating. Event screen+ matches perfectly with Mica, together the two fabrics offer an intriguing array of coordinated colour options.



Colour 01  
(60000 White)



Colour 02  
(61008 Light Beige)



Colour 03  
(61011 Light Brown)

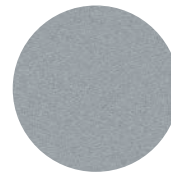

Colour 04  
(60004 Light Grey)

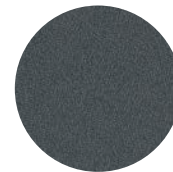

Colour 06  
(60021 Dark Grey)



Colour 05  
(60002 Light Grey)



Colour 07  
(60999 Black)

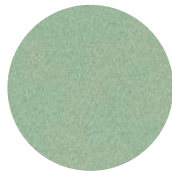

Colour 08  
(67015 Light Green)

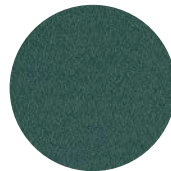

Colour 09  
(67017 Dark Green)

Price class  
1

## MICA BY GABRIEL

Post-consumer Recycled

MICA – SOPHISTICATED WITH A FOCUS ON SUSTAINABILITY

Mica is a cross functional, two-toned crêpe fabric. It is highly suitable not only for furniture but also for panels and screens. Made of 97% post-consumer recycled polyester, Eu-ecolable and Oekotex certified Mica is the excellent sustainable alternative.

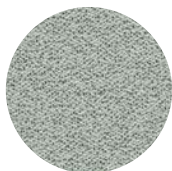

Colour 100  
(2500 60000 Light White)

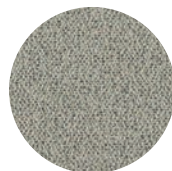

Colour 101  
(2500 61008 Light Beige)



Colour 102  
(2500 61011 Light Brown)

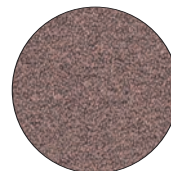

Colour 103  
(2501 64183 Light Red)

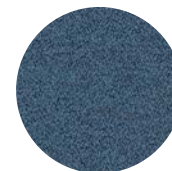

Colour 104  
(2501 66030 Blue)



Colour 108  
(2501 67015 Light Green)

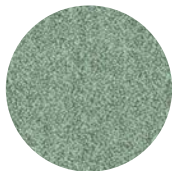

Colour 105  
(2500 67015 Light Green)

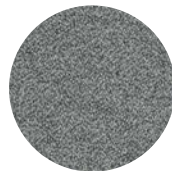

Colour 106  
(2501 60000 Dark White)

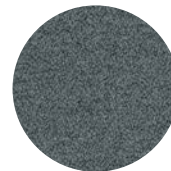

Colour 107  
(2501 60002 Grey)



Price class  
1

## CARLOW BY CAMIRA

### CARLOW – BRAVE AND CALM

Carlow is a screen textile made of 100% polypropylene. Carlow brings fascinating new colour blends which can be teamed with many other fabrics, and it is perfectly matched with the screen partner Cara. With its acoustically transparent properties the fabric helps maintain interior serenity, easy on both the eye and the ear.

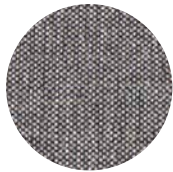

Colour 220  
(Convoy CLW09)

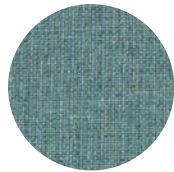

Colour 221  
(Cavan CLW15)

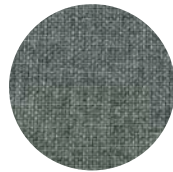

Colour 222  
(Parteen CLW23)

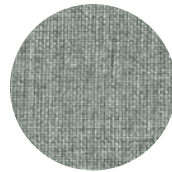

Colour 223  
(Tallow CLW01)

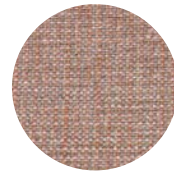

Colour 224  
(Callan CLW05)

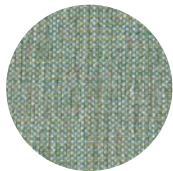

Colour 225  
(Carrick CLW18)

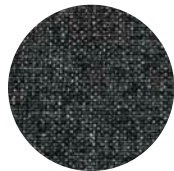

Colour 226  
(Avoca CLW22)

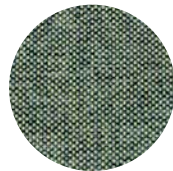

Colour 227  
(Emly CLW21)



Colour 228  
(Quin CLW04)

Price class  
1

## OMEGA BY AUDEJAS

### OMEGA – RUSTIC STRUCTURE AND EARTHY NUANCES.

Omega is a multifunctional textile made of 100% polyester. With its distinct and somewhat coarser structure, the textile becomes a timeless and stylish element in any type of environment. Through its classic and dampened expression, soft texture and earthy palette, Omega dresses both furniture and screens well.

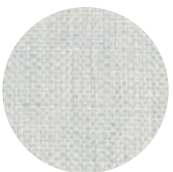

Colour 465  
(1/18)



Colour 466  
(1/16)

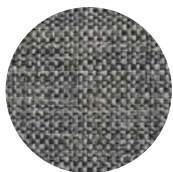

Colour 467  
(1/1)

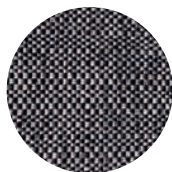

Colour 468  
(1/12)

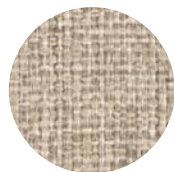

Colour 469  
(1/31)



Colour 470  
(1/33)

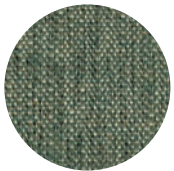

Colour 471  
(1/81)



Colour 472  
(1/36)



Colour 473  
(1/30)

Price class  
1

## SLOPE BY NEVOTEX

### SLOPE – MELANGE AND STRUCTURE

Slope can be used for both screens and soft seating. The textile is made of 100% polyester and the earthy colours are soft and pleasant. Combined with the fabric structure and melange expression Slope gives a unique touch to any furniture it upholsters.



Colour 250  
(17 Sand)



Colour 251  
(18 Lemongrass)



Colour 252  
(36 Orchid)

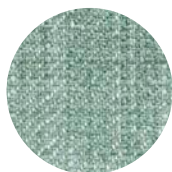

Colour 253  
(33 Crystal)

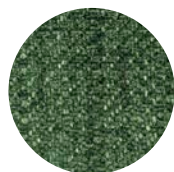

Colour 254  
(34 Bottle Green)

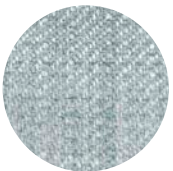

Colour 255  
(20 Ice Blue)

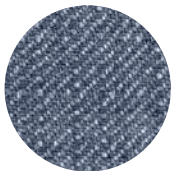

Colour 256  
(22 Ocean)



Colour 257  
(06 Silver)

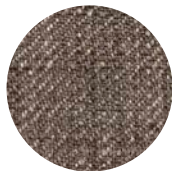

Colour 259  
(13 Mole)

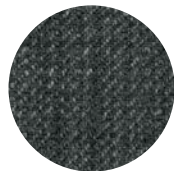

Colour 260  
(08 Stone)

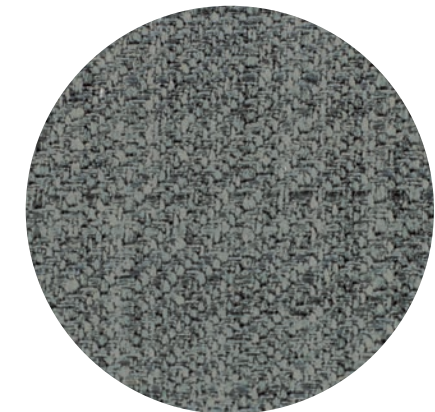

Colour 258  
(07 Steel)

Price class

1

## PEARL BY NEVOTEX

PEARL – AN EFFECTFUL FABRIC WITH CLASS

Pearl with its strong technical qualities and modern design, creates a beautiful and striking impression on both screens and soft seating. Earthy tones and a beautiful glow that sometimes gives the visual feeling of metal are both found in the textile's wide colour range.



Colour 335  
(00A9 Creme)



Colour 336  
(0019 Linen)

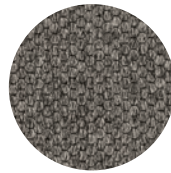

Colour 337  
(00G3 Stone)



Colour 338  
(00Q6 Java)

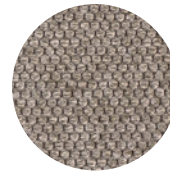

Colour 339  
(0037 Beige)



Colour 343  
(00S6 Rust)



Colour 340  
(0073 Taupe)



Colour 341  
(0098 Amber)

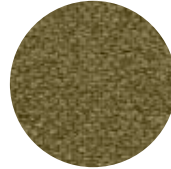

Colour 342  
(00Y8 Oregano)

Price class

1

## HUSH BY GABRIEL

HUSH – DISCRETE ELEGANCE

Hush is the perfect textile for screens thanks to its ability to blend in with other furniture with its sophisticated melange effect, all while giving a welcoming impression. Hush is made of a polyester and viscose blend. A mix between White and coloured fibers creates the fabrics soft colours structure, which softens rooms and gives them style and personality.

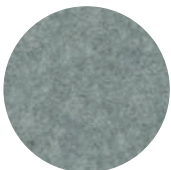

Colour 560  
(60155 Grey)

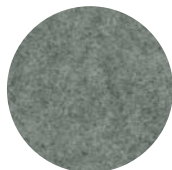

Colour 561  
(60158 Grey)

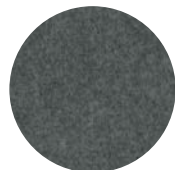

Colour 562  
(60159 Grey)

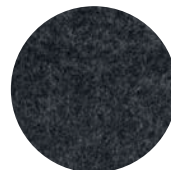

Colour 563  
(60900 Black)

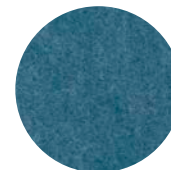

Colour 567  
(67046 Blue)



Colour 568  
(68102 Yellow)

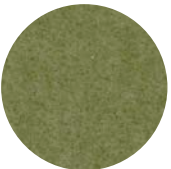

Colour 569  
(68103 Forest Green)

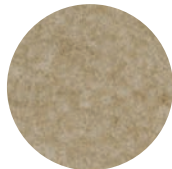

Colour 570  
(61174 Light Brown)

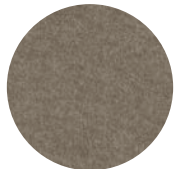

Colour 571  
(61225 Beige)



Colour 572  
(64148 Pink)

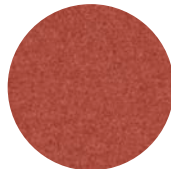

Colour 573  
(63058 Red)



Colour 574  
(66133 Dark Blue)

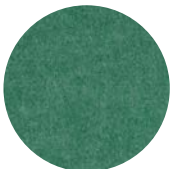

Colour 579  
(67048 Turquoise)



Colour 581  
(63083 Orange)



Colour 584  
(68159 Green)



Colour 587  
(61226 Light Beige)





Price class  
1

## XPRESS BY GABRIEL

### XPRESS – NATURAL DECORATION

Xpress is made of 100% polyester and its wide spectrum of colours makes it a much appreciated screen fabric. With its multicoloured structure and delicate matte surface, the nature seems to work itself into the decore with Xpress. It is optimal for minimalistic as well as colourful decoration in both private and public interiors.



Colour 540  
(60162 Light Beige)

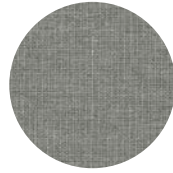

Colour 541  
(60003 Light Grey)

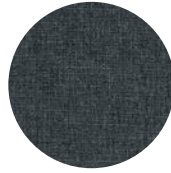

Colour 542  
(60004 Grey)

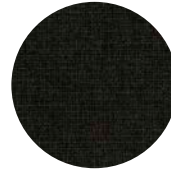

Colour 543  
(60999 Black)

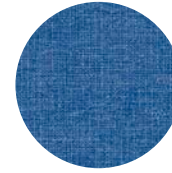

Colour 545  
(66009 Blue)



Colour 544  
(61183 Beige)

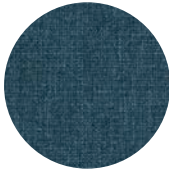

Colour 546  
(66010 Dark Blue)

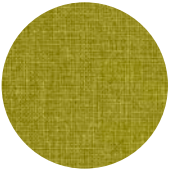

Colour 547  
(68002 Green)

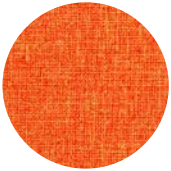

Colour 548  
(63013 orange)



Colour 549  
(65081 purple)



Price class  
1

## CARA BY CAMIRA

### CARA – A COLOURFUL VERTICAL SCREEN TEXTILE

Cara is a classic screen textile made of 100% polypropylene, available in a wide assortment of colours. The surface creates a cosy and stylish feeling in all kind of environments. This textile is largely acoustically transparent and therefore an excellent decorative choice for sound absorbing screens.

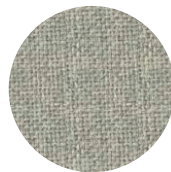

Colour 370  
(Spray EJ033)

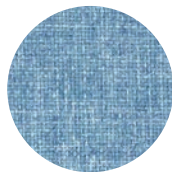

Colour 371  
(Dolphin EJ105)

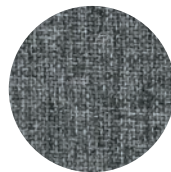

Colour 372  
(Lead EJ104)

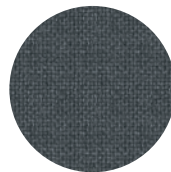

Colour 373  
(Merrick EJ048)

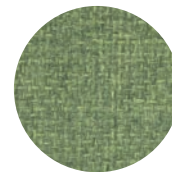

Colour 374  
(Fair Isle EJ186)



Colour 378  
(Lewick EJ194)

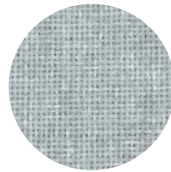

Colour 375  
(Glass EJ004)

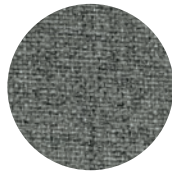

Colour 376  
(Portland EJ016)



Colour 377  
(Lomond EJ192)

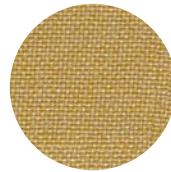

Colour 379  
(Maree EJ195)



Price class  
1

## HOUSTON REFLECT BY NEVOTEX

### HOUSTON REFLECT – QUALITY WITH TEXTURE

Houston Reflect is a popular alternative for both screens and soft seating due to a good combination of quality, texture and colour. The material composition of polyester and viscose gives the textile a beautiful luster. With a very high abrasion resistance, Houston Reflect is suitable for surfaces with high wear, such as public spaces and soft seating.



Colour 421  
(1002 sand 16)



Colour 423  
(1013 fudge 36)



Colour 426  
(1036 mosaik 46)

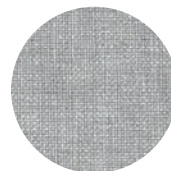

Colour 427  
(1011 Silver 17)

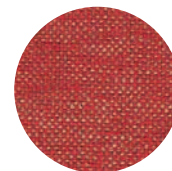

Colour 430  
(1040 Red 01)

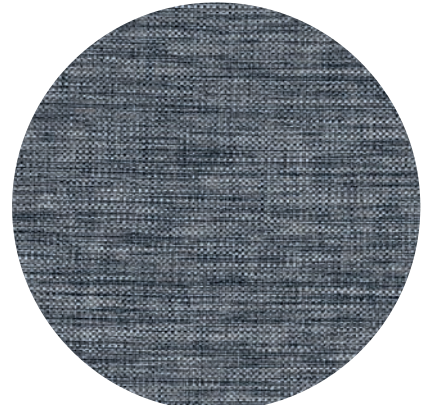

Colour 436  
(1053 Greystone)

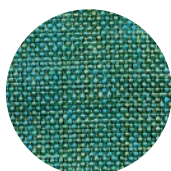

Colour 434  
(1027 petrol 22)

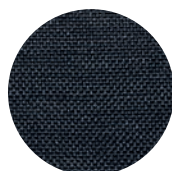

Colour 435  
(1038 Black 04)

Price class  
2

## KAIMAN BY FABRICOEUR

### KAIMAN – DURABLE AND MODERN

Kaiman is an artificial high quality vegan leather. The surface is made of 100% polyurethane, a strong and durable material. The surface finish makes it easy to wipe, making it suitable for upholstered furniture.



Colour 390  
(780 Black)



Colour 391  
(45 Grey)



Colour 392  
(120 Light Grey)



Colour 393  
(42 Attic)



Colour 394  
(430 Dark Green)



Colour 398  
(845 Loud Red)



Colour 395  
(374 Melba)



Colour 396  
(710 Taupe)



Colour 397  
(09 Blue)

Price class  
2

## NOBLE LUX BY FABRICOEUR

### NOBLE LUX – SIMPLICITY WITH AN EXCITING EXPRESSION

Noble Lux holds an exciting expression all while maintaining an elegant simplicity. The surface made of 100% polyester has suede qualities, leaving a nuance change on the fabric when touched. With a simple swipe in the opposite direction, the nuance is "painted" over again. The textile's marble effect makes each piece of furniture unique.



Colour 350  
(608 Light Beige)



Colour 351  
(46 Anthracite)

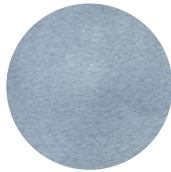

Colour 352  
(5005 Baby Blue)

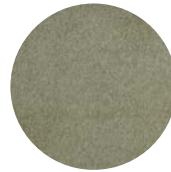

Colour 353  
(735 Reed)



Colour 360  
(846 Bright Pink)



Colour 354  
(165 Nougat)



Colour 355  
(709 Argent)



Colour 356  
(429 Green)



Colour 357  
(50 Orange)



Colour 358  
(32 Red)

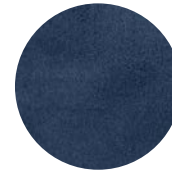

Colour 359  
(09 Blue)

Price class  
2

## LIDO BY NEVOTEX

### LIDO – A SOFT AND VERSATILE TEXTILE

Lido is a popular upholstery textile made of 100% polyester. Its strong technical properties and high quality makes the fabric an excellent choice for both screens and soft seating. With its broad colour scale, Lido is a great fit for modern interiors and gives the whole room a lift.

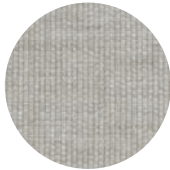

Colour 200  
(132 Toned)

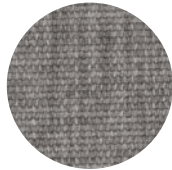

Colour 201  
(17 Concrete)



Colour 203  
(71 Plum)

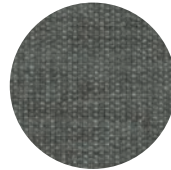

Colour 204  
(129 Savile Grey)

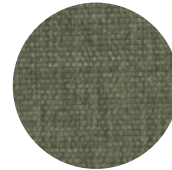

Colour 205  
(134 Antique Green)



Colour 202  
(148 Orchid)

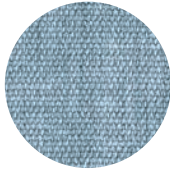

Colour 206  
(103 Sky)



Colour 207  
(136 Power Blue)



Colour 208  
(154 Mustard)

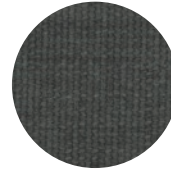

Colour 209  
(7 Grafit)

Price class  
2

## TWIST BY GABRIEL

### TWIST – ELEGANT AND CHARACTERISTIC

Twist is an elegant screen textile woven in the non-flammable yarn Trevira CS. It is highly suitable for use in areas where requirements regarding fire and safety are high.

Twist has a beautiful and characteristic structure and at the same time a calm solid colour surface, perfect for most vertical surfaces. With its colour palette and natural surface Twist works great on its own or together with other fabrics.



Colour 440  
(60076 Light Grey)

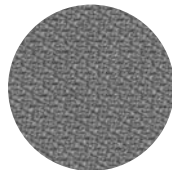

Colour 441  
(60011 Medium Grey)



Colour 442  
(60021 Dark Grey)

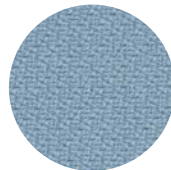

Colour 444  
(67004 Greenblue)

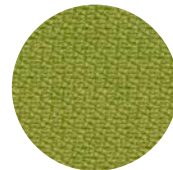

Colour 445  
(68119 Yellowgreen)



Colour 448  
(61104 Beige)



Colour 447  
(60999 Black)

Price class  
2

## RIVET BY CAMIRA

RIVET - CIRCULAR QUALITY AND AESTHETICS

Rivet is a textile that connects both to the modern workplace and forms a bridge between traditional and modern textiles. Rivet is designed to blend the aesthetic qualities of luxury woolen clothing and modern sportswear and has a Light texture. Rivet is made from 100% recycled polyester from used plastic bottles.

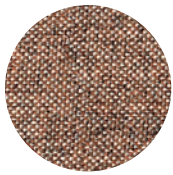

Colour 700  
(Molten EGL09)

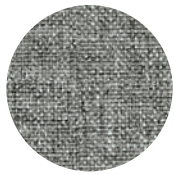

Colour 701  
(Vitreous EGL01)

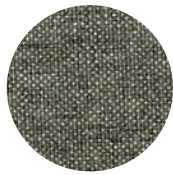

Colour 702  
(Cast EGL25)

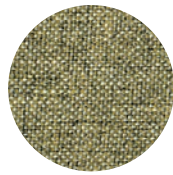

Colour 703  
(Alloy EGL05)

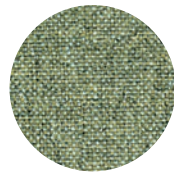

Colour 705  
(Burnish EGL11)

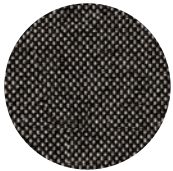

Colour 706  
(Charcoal EGL37)

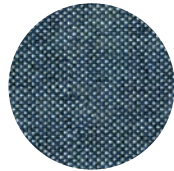

Colour 707  
(Hammer EGL27)

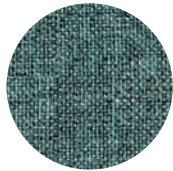

Colour 708  
(Verdigris EGL21)

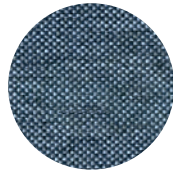

Colour 709  
(Crucible EGL24)

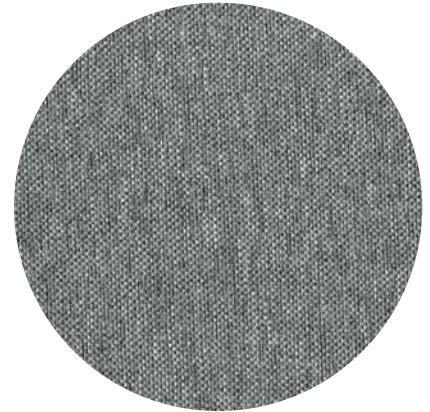

Colour 704  
(Galvanise EGL26)

Price class  
2

## ERA BY CAMIRA

ERA - DISCRETE AND SOPHISTICATED

Era is a subtle, two tone polyester fabric containing stretch in both directions for easy upholstery of furniture. The small herringbone weave gives the textile a discrete modern texture while close up you see how the colouring technique provides a unique and interesting pattern. The palette incorporates playful brights and sophisticated muted tones.



Colour 310  
(CSE46 Memo)



Colour 311  
(CSE13 Present)



Colour 312  
(CSE45 Prompt)



Colour 313  
(CSE41 Quota)



Colour 314  
(CSE34 Endurance)



Colour 315  
(CSE33 Analogue)



Colour 316  
(CSE19 Calendar)



Colour 317  
(CSE42 Range)

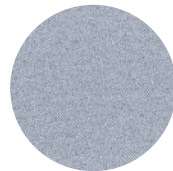

Colour 318  
(CSE39 Youth)

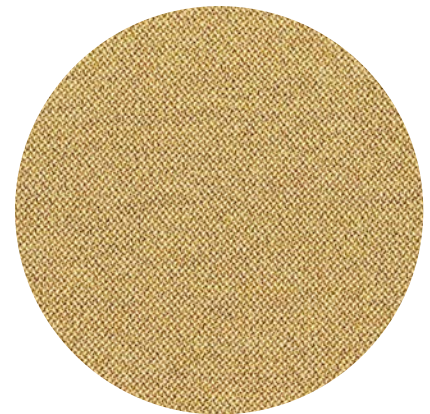

Colour 319  
(CSE31 Splitsecond)

ALLY BY LUDVIG SVENSSON

Price class  
3

ALLY - THE BEAUTY IN THE CLEAN, UNMADE-UP AND VARIETY

A Scandinavian design language, a fantastic natural material and solid craftsmanship sum up the furniture fabric Ally. It's made from wool of Norwegian sheep, which give the textile its significant look. The wide range of colours are dominated by natural tones that have been carefully chosen to bring out the wool's natural variations. The fabric is yarn-dyed, which allows the interplay of colours to form a pleasant pattern.

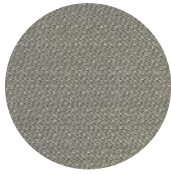

Colour 480  
(Ally 6540)

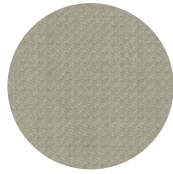

Colour 481  
(Ally 6730)

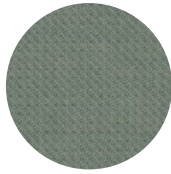

Colour 482  
(Ally 5861)



Colour 483  
(Ally 5881)

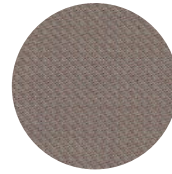

Colour 484  
(Ally 3952)



Colour 485  
(Ally 8330)

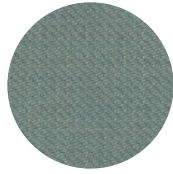

Colour 486  
(Ally 5041)

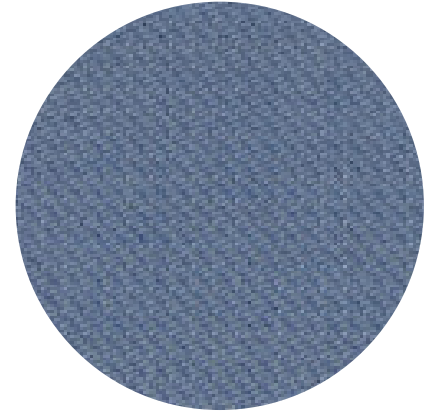

Colour 487  
(Ally 4443)

BOND BY GABRIEL *Post-consumer Recycled*

Price class  
3

BOND – ADDS CHARACTER TO ALL INTERIORS

Bond is a multifunctional upholstery textile, made of 98% post-consumer recycled polyester and 2% PES. With excellent technical aspects in combination with a natural touch and discrete graphic design, Bond suits all types of furniture and occasions. With a very high abrasion resistance, Bond is a highly durable textile.

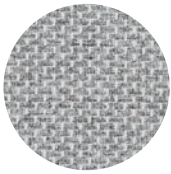

Colour 750  
(60094 Light Grey)

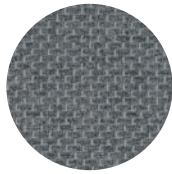

Colour 751  
(60096 Grey)

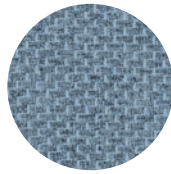

Colour 752  
(66157 Light Blue)

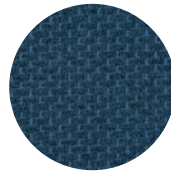

Colour 753  
(66159 Dark Blue)

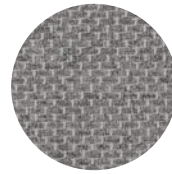

Colour 754  
(61158 Light Brown)

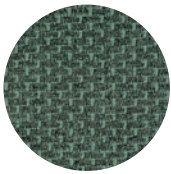

Colour 755  
(68176 Green)

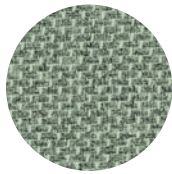

Colour 756  
(68175 Light Green)

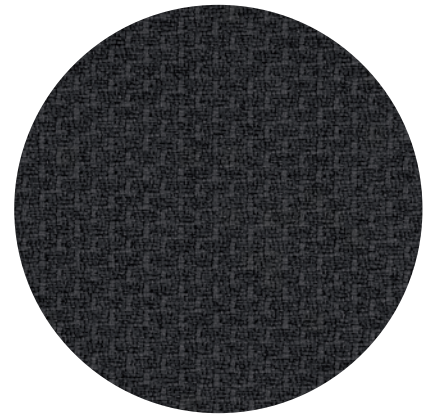

Colour 757  
(60097 Dark Grey)

Price class  
3

## BLAZER BY CAMIRA

### BLAZER – VERSATILITY AND QUALITY

Blazer is made of 100% virgin wool from New Zealand, giving it a soft surface that is pleasant for both screens and soft seating. For a broader colour palette with the same feeling, take a look at Synergy.

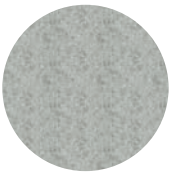

Colour 30  
(CUZ28 Silverdale)

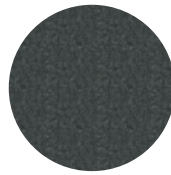

Colour 35  
(CUZ30 Silcoats)

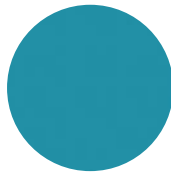

Colour 51  
(CUZ02 Aston)

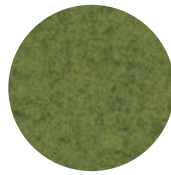

Colour 66  
(CUZ1K Camphill)

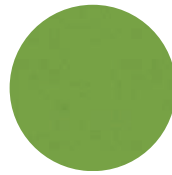

Colour 67  
(CUZ1L Newport)



Colour 64  
(CUZ86 St Andrews)

Price class  
3

## BLAZER LITE BY CAMIRA

### BLAZER LITE – A FINE VERSION OF BLAZER

Blazer Lite is a finer version Blazer making it lighter in weight for use on desk screens, panels and other vertical surfaces. With a broad palette of melange and single coloured nuances, it's perfect in combination with both Blazer and Synergy.



Colour: 800  
(Retreat, LTH39)

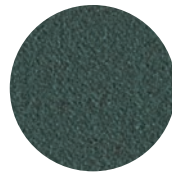

Colour: 801  
(Hush, LTH42)

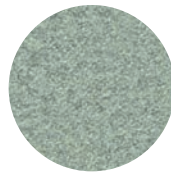

Colour: 802  
(Pillow, LTH43)

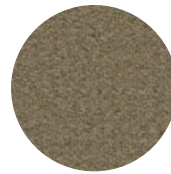

Colour: 803  
(Tender, LTH53)

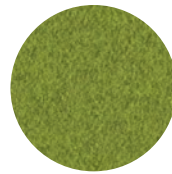

Colour: 804  
(Happy, LTH55)



Colour: 809  
(Daydream, LTH46)

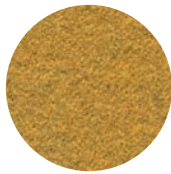

Colour: 805  
(Buddha, LTH56)

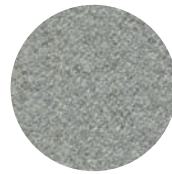

Colour: 806  
(True, LTH61)

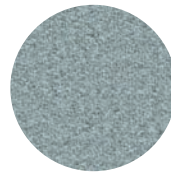

Colour: 807  
(Harmony, LTH63)

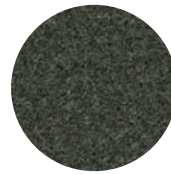

Colour: 808  
(Solace, LTH70)

Price class  
3

## SYNERGY BY CAMIRA

### SYNERGY – A FACETED TEXTILE

Synergy is made of 95% virgin wool and 5% polyamid, a composition that gives the fabric a very high abrasion resistance. The textile is soft, strong and Light, while keeping a depth that fascinates. The wool yarn has been carefully woven together with thin nylon, making Synergy a multifunctional textile that suits both soft seating and screens without losing the feel or look of a classic wool fabric.



Colour 620  
(Affix LDS 32)



Colour 621  
(Affinity LDS 74)

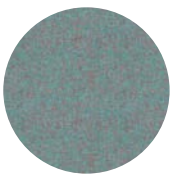

Colour 622  
(Kinship LDS 56)



Colour 623  
(Support LDS 55)



Colour 624  
(Serendipity LDS 08)



Colour 626  
(Interfuse LDS 48)



Colour 625  
(Integrate LDS 47)

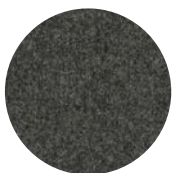

Colour 627  
(Mix LDS 17)

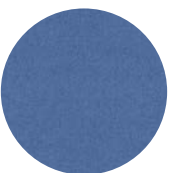

Colour 628  
(Guild LDS 63)

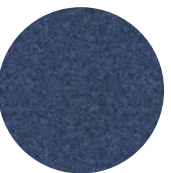

Colour 629  
(Alike LDS 62)

Price class  
4

## REMIX 3 BY KVADRAT

### REMIX 3 – QUALITY AND DESIGN IN ONE

Remix is a textile for both screens and soft seating, made of 90% virgin wool and 10% nylon. Wool is an excellent upholstery fabric as it is durable, dirt repellent, comfortable and flame retardant. The textile is designed by the recognized Italian designer Giulio Ridolfo.



Colour 600  
(123 Light Grey)



Colour 601  
(163 Dark Grey)



Colour 602  
(183 Black)

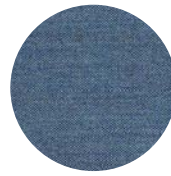

Colour 604  
(743 Blue)

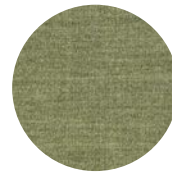

Colour 605  
(933 Green)



Colour 606  
(682 Lilac)



Colour 607  
(982 Dark Green)



Colour 608  
(233 Greige)



Colour 603  
(223 Beige)

Price class  
4

## ILLUSION II BY NEVOTEX

### Illusion II – ARTIFICIAL LEATHER FOR EASY CLEANING

Illusion II is a PU (Polyurethane) artificial leather that can be used in a number of different areas. It fits perfectly with furniture and furnishings of various kinds. Artificial leather can advantageously be used in healthcare environments and other environments where high demands are placed on cleaning.



Färgkod 143  
(Fg 44388 Dark camel)



Färgkod 144  
(Trend Fg 48013 Chocolate)



Färgkod 145  
((Fg 00110 Black)



Färgkod 146  
(Fg 57069 Light grey)



Färgkod 147  
(Trend Fg 58290 Stone)



Färgkod 148  
(Fg 68746 Blue)



Färgkod 149  
(Trend Fg 77773 Dark green)



Färgkod 150  
(Fg 87241 Taupe)

## ACOUSTIC NONWOVEN



Colour: 901  
(White Acoustic Nonwoven)

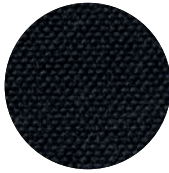

Colour: 902  
(Black Acoustic Nonwoven)

With its air-permeable microperforating properties, Acoustic Nonwoven reflects the sound minimally when it hits the surface so that the sound absorber can absorb at maximum. The Acoustic Nonwoven provides a nice smooth surface that can withstand moisture, is odorless, does not rot or mold and does not create any allergies. Acoustic Nonwoven is also used as a barrier between insulation and air gaps, for example when furring stripes are used on walls in sports halls, concert halls, music studios etc. or as a surface layer on sound absorbers and suspended ceiling.

## CORE MATERIAL ECOSUND "RAW"



Colour: 1  
(raw White)



Colour: 2  
(raw Black)

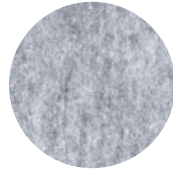

Colour: 3  
(raw Grey)



Colour: 6  
(raw Light Grey)

EcoSUND is our unique core material for sound absorbent. It's good for both the working environment and our nature. EcoSUND is made of 50% recycled PET and 50% new PET fibres. The fibres EcoSUND is made of are approved according to Oeko-Tex® Standard 100. No emissions, EcoSUND® is completely free from glue/adhesives and therefore it doesn't release any emissions or gases. No dangerous fibres, EcoSUND doesn't release any fibres that itch, irritate or cause allergic reactions.

## FRAMES

Frames for Collage, Tell-Us, Storyboard and Print.



Colour: 1  
(White)



Colour: 2  
(Black)

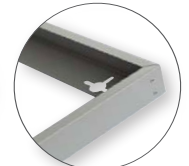

Colour: 3  
(Grey)

Frames for Collage and Print. In size 1200x1200 + 1200x1600.



Colour: 7  
(Ash)

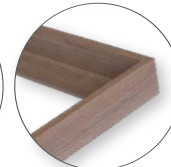

Colour: 8  
(Walnut)

## EXPRESS ORDER

Choose express order and get your screens\* produced in 10 working days

\*Express order applies when ordering ScreenIT Standard, ScreenIT A30 Desk screen, ScreenIT Flexible and ScreenIT A30 Floor screen in textiles Event Screen+ and Hush. Choose from eight selected colours, four zips or any seam, see images below. Maximum 100 screens/order in standard catalogue version. Placed order can not be changed or cancelled.

Mark the order with "Express Order". Screens with straight corners, special screens, deviating hole images, reinforced screens, screens with built in rail and booths are not included in the offer.

### EVENT SCREEN +

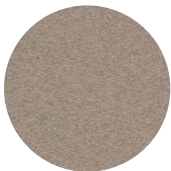

Colour 03  
(61011 Light brown)



Colour 04  
(60004 Light Grey)



Colour 06  
(60021 Dark Grey)



Colour 07  
(60999 Black)

### HUSH

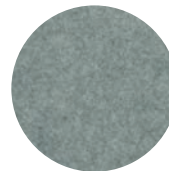

Colour 560  
(60155 Grey)

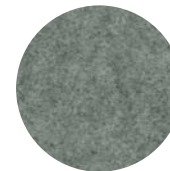

Colour 561  
(60158 Grey)

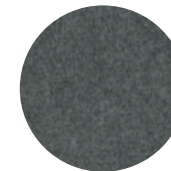

Colour 562  
(60159 Grey)

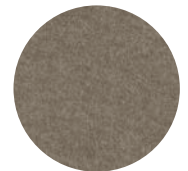

Colour 571  
(61225 Beige)

### ZIPS/SEAMS



Colour zip: 100, seam: 200 (White)



Colour zip: 101, seam: 201 (Black)



Colour zip: 121 (wine Red)

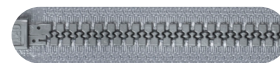

Colour zip: 106 (Silver)

Colour code seam, see page 17.

## HANGERS

Hangers for Effekt EcoSUND Pendant.

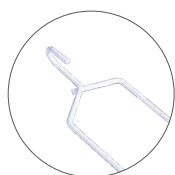

643000-1  
(White)



643000-2  
(Black)

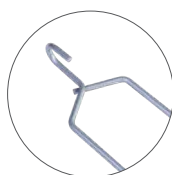

643000-3  
(Silver)

## LAMINATE



911  
(Oak)



912  
(Walnut)



913  
(White)

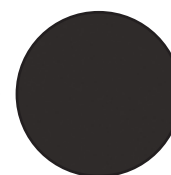

914  
(Black)



915  
(Ash)



# ZIPS



Colour zip: 100 (White)



Colour zip: 101 (Black)

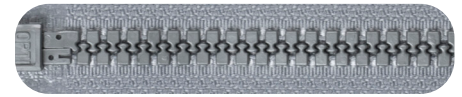

Colour zip: 106 (Silver)



Colour zip: 114 (Off White)

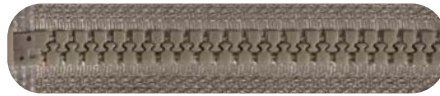

Colour zip: 117 (Aand)



Colour zip: 118 (Hazel Brown)



Colour zip: 119 (Misty Pink)

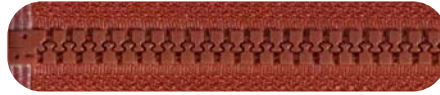

Colour zip: 120 (Rust)



Colour zip: 121 (Wine Red)

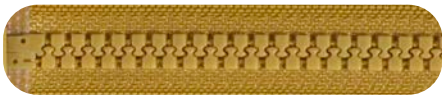

Colour zip: 122 (Mustard Yellow)



Colour zip: 123 (Forest Green)



Colour zip: 124 (Indigo Blue)



Colour zip: 107 (fishbone Black/White)



Colour zip: 108 (fishbone Black/Black)



Colour zip: 112 (fishbone White/Black)

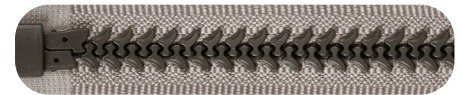

Colour zip: 113 (fishbone Silver Grey/Brown)

**NOTE!**

Colour deviation on our textiles and zippers can occur during printigt. For exact colours, order colour cards from us.

# SEAMS



Colour seam: 200 (White)



Colour seam: 201 (Black)



Colour seam: 214 (Off White)



Colour seam: 217 (Sand)



Colour seam: 218 (Hazel Brown)



Colour seam: 219 (Misty Pink)



Colour seam: 220 (Rust)



Colour seam: 221 (Wine Red)



Colour seam: 222 (Mustard)



Colour seam: 223 (Forest Green)



Colour seam: 224 (Indigo Blue)



Colour seam: 206 (seam like textile)



Textile suitable for screens and panels



Textile suitable for soft seating

A set cost is added when ordering outside of the standard textile range. Please contact [info@gotessons.se](mailto:info@gotessons.se) for more information.

Creek can only be chosen to articles on page 19-21.  
 Care can be chosen to all articles on page 20-21, except Sandy.  
 Illusion II works for all our articles.

Price class  
**2**

## CARE BY FABRICOEUR

### CARE - ARTIFICIAL LEATHER FOR MEDICAL CARE

Care is a PU (Polyurethane) artificial leather that can be used in hospitals/care as well as indoor and outdoor furniture. The surface of the textile is without structure, which makes it easy to clean and it has properties such as oil-resistant, urine-resistant, blood-resistant and alcoholable up to 70% alcohol.



Colour 140  
(White)



Colour 141  
(Black)

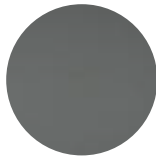

Colour 142  
(Light Grey)



Price class  
**4**

## CREEK BY VESCOM

### CREEK - DURABLE VINYL WITH A TEXTILE LOOK

Creek's irregular melange surface gives it a soft design that reminds one of the appearance of linen fabric as well as having all of the strong, technical qualities that are found in a vinyl. The material can be disinfected with alcohol based detergents, which makes the products excellent choices in the healthcare sector as well as for different school and education environments.



Colour 501  
(7053.03)



Colour 506  
(7053.13)

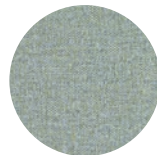

Colour 507  
(7053.21)



Price class  
**4**

## ILLUSION II BY NEVOTEX

### ILLUSION II - ARTIFICIAL LEATHER FOR EASY CLEANING

Illusion II is a PU (Polyurethane) artificial leather that can be used in a number of different areas. It fits perfectly with furniture and furnishings of various kinds. Artificial leather can advantageously be used in healthcare environments and other environments where high demands are placed on cleaning.



Färgkod 143  
(Fg 44388 Dark camel)



Färgkod 144  
(Trend Fg 48013 Chocolate)



Färgkod 145  
((Fg 00110 Black)



Färgkod 146  
(Fg 57069 Light grey)



Färgkod 147  
(Trend Fg 58290 Stone)



Färgkod 148  
(Fg 68746 Blue)



Färgkod 149  
(Trend Fg 77773 Dark green)



Färgkod 150  
(Fg 87241 Taupe)



Several of our products can be used in hospital environments and other similar operations. To ensure that the product meets the hygienic requirements placed on products in these environments, we recommend using the fabrics listed on this page. These textiles can be disinfected with cleaning products and have a moisture barrier that prevents bacteria from penetrating the product.



### SANDY SOFA

Constructed of MDF, covered with foam and textile.  
Base in oak, ash, walnut, black or white laminate.  
Mounted with magnets.

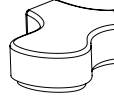

**Sandy middle section**  
W. 1450 H. 460 D. 1260  
647620-

**Pricer. 4**  
| 1967,55 |

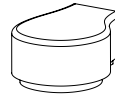

**Sandy outer section**  
W. 990 H. 460 D. 785  
647621-

| 1329,26 |



**Sandy pouf**  
W. 945 H. 460 D. 745  
647602-

| 1167,34 |

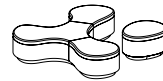

**Sandy Sofa with pouf**  
A complete sofa with 1x middle section, 2x outer sections and 1x pouf.  
All sections in the same textile and the same laminate. Mounted with magnets.  
W. 1450 H. 460 D. 1260  
647623-

| 4839,89 |

#### Laminate

- 911 Oak
- 912 Walnut
- 913 White
- 914 Black
- 915 Ash

#### How to order Sandy:

- 1: Choose Sandy section. Example: 647620 (middle section).
- 2: Choose textile for Sandy. Example: 647620-338 (Pearl 338 Java).  
Colour on textile = color on seam.
- 3: Choose color on laminate. Example: 647620-338-915 ( ash).



### OFFICE BALLZ

#### Office Ballz

Delivered with a pump. Max loading 125 kg.

		<b>Pricer. 2</b>	<b>Pricer. 4</b>
640055-	Ø 550	375,21	505,74
640065-	Ø 650	392,77	519,15

Specify the article number as follow:  
Office Ballz - textile colour - zip colour.  
Choose Care, Creek or Illusion II.  
Not available with fishbone zip.  
Seam will be similar to zipper tape.



### OFFICE NAP

#### Office Nap

Inner bag covered with the textile of your choice.

The bottom is always in grey artificial leather.

		<b>Pricer. 4</b>
W. 600 H. 300 L. 1400	640075-	820,64

Specify the article number as follow:  
Office Nap - textile colour - zip colour.  
Choose Creek or Illusion II.  
Not available with fishbone zip.  
Seam will be similar to zipper tape.



### IQSEAT/IQUBE

#### iQseat

Seam is always like textile. Details/wheels can be chosen in white or black. Two lockable wheels. Max loading: 144 kg.

		<b>Pricer. 2</b>	<b>Pricer. 4</b>
Seat height: 500 mm.	W. 500 H. 840 D. 690		
647503-	white	1205,96	1297,66
647504-	black	1205,96	1297,66

#### iQube

Seam always matches the fabric. Wheels in white or black of which two are lockable. Maximum load 144 kg. Seat height 500 mm. The product are delivered as pre-assembled.

		<b>Pricer. 2</b>	<b>Pricer. 4</b>
W. 500 H. 500 D. 500			
647510-	white	802,77	902,55
647511-	black	802,77	902,55

Specify the article number as follow:  
Qseat/iQube - Colour of textile.  
Choose Care, Creek or Illusion II.  
Seam will be similar to textile colour.

SCREENIT A30 DESK SCREEN



Specify the article number as follows:  
Screen - Color of textile (seam will be similar to textile).  
Choose textile Care, Creek or Illusion II.

ScreenIT A30 desk screen 650 mm

			Pricer. 2	Pricer. 4
<b>With seam</b>				
642960-	W. 600	H. 650	186,17	265,00
642970-	W. 700	H. 650	195,53	303,62
643080-	W. 800	H. 650	192,77	443,30
643120-	W. 1200	H. 650	276,91	505,74
643140-	W. 1400	H. 650	289,36	512,87
643160-	W. 1600	H. 650	302,02	515,74
643180-	W. 1800	H. 650	347,77	552,98
643200-	W. 2000	H. 650	406,28	633,83
<b>With zip</b>				
642960-	W. 600	H. 650	210,96	289,68
642970-	W. 700	H. 650	222,98	330,21
643080-	W. 800	H. 650	236,81	486,81
643120-	W. 1200	H. 650	320,96	549,15
643140-	W. 1400	H. 650	333,40	556,49
643160-	W. 1600	H. 650	346,06	559,26
643180-	W. 1800	H. 650	391,81	596,60
643200-	W. 2000	H. 650	450,43	677,45

ScreenIT A30 desk screen 800 mm

			Pricer. 2	Pricer. 4
<b>With seam</b>				
664060-	W. 600	H. 800	192,87	271,60
664070-	W. 700	H. 800	234,26	409,79
664080-	W. 800	H. 800	267,23	667,02
664120-	W. 1200	H. 800	330,00	702,66
664140-	W. 1400	H. 800	364,15	802,13
664160-	W. 1600	H. 800	397,77	873,30
664180-	W. 1800	H. 800	435,32	944,68
664200-	W. 2000	H. 800	471,38	1072,77
<b>With zip</b>				
664060-	W. 600	H. 800	217,66	296,06
664070-	W. 700	H. 800	288,09	459,68
664080-	W. 800	H. 800	311,06	710,43
664120-	W. 1200	H. 800	373,83	746,28
664140-	W. 1400	H. 800	408,09	845,64
664160-	W. 1600	H. 800	441,60	917,02
664180-	W. 1800	H. 800	479,26	988,19
664200-	W. 2000	H. 800	515,43	1116,28

SCREENIT A30 FLOOR SCREEN

ScreenIT A30 floor screen

			Pricer. 2	Pricer. 4
<b>With seam</b>				
632120-	W. 800	H. 1200	337,13	702,66
632140-	W. 800	H. 1400	372,13	802,13
632160-	W. 800	H. 1600	406,28	873,30
632180-	W. 800	H. 1800	444,26	944,68
634120-	W. 1000	H. 1200	412,02	775,21
634140-	W. 1000	H. 1400	431,70	818,19
634160-	W. 1000	H. 1600	448,19	903,30
634180-	W. 1000	H. 1800	563,30	946,28
636120-	W. 1200	H. 1200	471,81	782,55
636140-	W. 1200	H. 1400	488,62	839,68
636160-	W. 1200	H. 1600	506,28	946,81
636180-	W. 1200	H. 1800	595,21	988,83
669120-	W. 1400	H. 1200	488,62	839,68
669140-	W. 1400	H. 1400	535,11	1098,19
669160-	W. 1400	H. 1600	570,00	1192,45
669180-	W. 1400	H. 1800	667,23	1286,38
653120-	W. 1600	H. 1200	512,55	946,81
653140-	W. 1600	H. 1400	570,00	1192,45
653160-	W. 1600	H. 1600	627,98	1288,40
<b>With zip</b>				
632120-	W. 800	H. 1200	381,28	746,28
632140-	W. 800	H. 1400	415,96	845,64
632160-	W. 800	H. 1600	450,43	917,02
632180-	W. 800	H. 1800	488,30	988,19
634120-	W. 1000	H. 1200	455,96	818,62
634140-	W. 1000	H. 1400	475,85	861,91
634160-	W. 1000	H. 1600	492,13	946,81
634180-	W. 1000	H. 1800	616,49	988,83
636120-	W. 1200	H. 1200	515,96	826,06
636140-	W. 1200	H. 1400	532,66	882,98
636160-	W. 1200	H. 1600	550,21	990,11
636180-	W. 1200	H. 1800	648,40	1010,11
669120-	W. 1400	H. 1200	532,66	882,98
669140-	W. 1400	H. 1400	579,04	1157,98
669160-	W. 1400	H. 1600	613,83	1251,81
669180-	W. 1400	H. 1800	710,96	1345,11
653120-	W. 1600	H. 1200	556,38	990,11
653140-	W. 1600	H. 1400	613,83	1251,81
653160-	W. 1600	H. 1600	671,70	1352,13

SCREENIT HEALTH & CARE

**ScreenIT Health & Care**

*Built with a wood frame with 30 mm core material and dressed in vinyl that can easily be disinfected and wiped with alcohol based cleaner. Can be connected with press studs.*

**ScreenIT Health & Care incl. foot set with wheels**

*Foot set with wheels is always white.*

	<b>Pricer. 2</b>	<b>Pricer. 4</b>
810115- W. 1150 H. 1860	876,06	1049,68

**ScreenIT Health & Care incl. foot set**

*Foot set is always white.*

811115- W. 1150 H. 1860	766,49	970,96
-------------------------	--------	--------

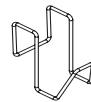

**Hook for Health & care**

671092-1	white	13.09
----------	-------	-------

---

Specify the article number as follows:  
 Screen - Color of textile (seam will be similar to textile).  
 Choose textile Care, Creek or Illusion II.



ScreenIT Health & Care is a floor screen that has been designed for the health care sector. It is built with a wood frame, filled with 30 mm soft core material and dressed in vinyl, which is easy to disinfect and wipe clean with alcohol based cleaner. The screen's long sides are both equipped with press studs to enable connecting as many screens as you want. Choose wheels or foot set for the screen for mobility and storage.

Thanks to the air gap between the bottom of the screen and the floor, cleaning under and around the screen is made easier. Usable in spaces such as: waiting rooms, corridors, schools, lunch rooms and the health and care sectors in general.





**(A)**

**Clamp set for desk screen**

For up to 42 mm desks. 2 pcs in one pack.

641010-1 White -2 Black -3 Silver 55.21/set

**Clamp set for desk screen longer than 1800 mm**

For up to 42 mm desks, 3 pcs in one pack.

641056-1 White -2 Black -3 Silver 82.66/set



**(B)**

**Clamp set for desk screen**

For up to 72 mm desks, 2 pcs in one pack.

641025-1 White -2 Black -3 Silver 66.17/set

**Clamp set for desk screen longer than 1800 mm**

For up to 72 mm desks, 3 pcs in one pack.

641035-1 White -2 Black -3 Silver 90.32/set



**(C)**

**Corner clamp set, A30**

For clamping side and frontal screens at 90°.

For 42 mm desks. 2 pcs in one pack.

641050-1 White -2 Black -3 Silver 60.53/set



**(D)**

**Corner mount set A30**

For clamping side and frontal screens at 90°.

For 72 mm desks. 2 pcs in one pack.

641045-1 White -2 Black -3 Silver 73.51/set



**(E)**

**Desk mount Light**

Mounted with screws under the desk.

2 pcs mounts included. Max load 6 kg.

643047-1 White -2 Black -3 Silver 42.98/set

**Desk mount Light for desk screen longer than 1800 mm**

Mounted with screws under the desk. 3 pcs mounts included. Max load 6 kg.

643049-1 White -2 Black -3 silver 75.53/set



**(F)**

**Desk mount corner Light**

Used for corner mount. Mounted with screws under the desk. 2 pcs mounts included.

Max load 6 kg.

643046-1 White -2 Black -3 Silver 42.98/set

**Deskcorner mount Light for desk screen longer than 1800 mm**

Used for corner mount. Mounted with screws under the desk. 3 pcs mounts included.

Max load 6 kg.

643048-1 White -2 Black -3 Silver 75.53/set

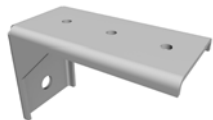

**(G)**

**Desk mount set for desk screen**

To be mounted with screws under the desk, 2 pcs in one pack.

641020-1 White -2 Black -3 Silver 55.21/set

**Desk mount set for desk screen longer than 1800 mm**

To be mounted with screws under the desk, 3 pcs in one pack.

641057-1 White -2 Black -3 Silver 82.66/set



**(H)**

**Corner mount set A30**

For mounting side and frontal screens at 90°.

To be mounted with screws under the desk, 2 pcs in one pack.

641058-1 White -2 Black -3 Silver 55.21/set



**(I)**

**Desk mount set Slide-in.**

To be mounted with screws under the desk, 2 pcs in one pack.

641085-1 White -2 Black -3 Silver 73.51/set



**(J)**

**Desk mount set for Halfpipe with keyhole**

To be mounted with screws under the desk, 2 pcs in one pack.

642065-3 Silver 66.81/set



**(K)**

**Desk clamp adjustable for screens without holes**

For up to 42 mm desks. 2 pcs in one pack, right/left.

642032-1 White -2 Black -3 Silver 71.38/set



**(L)**

**Desk mount adjustable for screens without holes**

To be mounted with screws under the desk. Not possible to use 2 mounts in the same angle. 2 pcs in one pack, right/left.

642033-1 White -2 Black -3 Silver 56.91/set

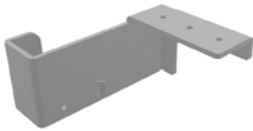

(M)

**Desk mount adjustable extended for screens without holes**

To be mounted with screws under the desk, 2 pcs in one pack, right/left.

642043-1 White -2 Black -3 Silver 67.66/set



(N)

**Clamp for desk with aluminium rail**

2 pcs in one pack.

642062-1 White -2 Black -3 Silver 50.00/set



(O)

**OnOff Desk mount**

One part is mounted with screw under the desk. One part is mounted on the screen. To hook on and off. 2 pcs in one pack.

642077-1 White -2 Black -3 Silver 67.98/set



(P)

**Desk clamp for ScreenIT A30 Sidescreen**

For up to 42 mm desks. 1 clamp included.

642068-1 White -2 Black -3 Silver 59.79



(Q)

**Desk clamp right for ScreenIT A30 Sidescreen**

For up to 42 mm desks. 1 clamp included.

642082-1 White -2 Black -3 Silver 61.38



(R)

**Desk clamp left for ScreenIT A30 Sidescreen**

For up to 42 mm desks. 1 clamp included.

642083-1 White -2 Black -3 Silver 61.38

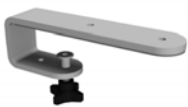

(S)

**Desk clamp Small for ScreenIT A30 Sidescreen**

For up to 27 mm desks. 1 clamp included.

643011-1White -2 Black -3 Silver 59.79



(T)

**Desk clamp Small right for ScreenIT A30 Sidescreen**

For up to 27 mm desks. 1 clamp included.

643012-1White -2 Black -3 Silver 61.38



(U)

**Desk clamp Small left for ScreenIT A30 Sidescreen**

For up to 27 mm desks. 1 clamp included.

643013-1White -2 Black -3 Silver 61.38



(V)

**Metal plate for angled edge desks**

When the clamps need stable grip with angled edge. 1 clamp included.

66500 Silver 24.47



(X)

**Angle bracket for desk screen**

Used for corner mounting to hold the screens together. 1pc mount incl.

**Angle bracket for ScreenIT Standard**

642034-1 White -2 Black -3 Silver 14.15

**Angle bracket for ScreenIT AT40**

642036-1 White -2 Black -3 Silver 14.15

**Angle bracket for ScreenIT A30/A40**

642046-1 White -2 Black -3 Silver 14.15



(Y)

**Clamp set for booth, package**

For up to 42 mm desks. 6 clamps includes. 2 clamps and 4 corner clamps.

641068-1White -2 Black -3 Silver 167.98/set

Z



**Clamp set for booth, package**  
For up to 72 mm desks. 6 clamps includes.  
2 clamps and 4 corner clamps.  
641071-1White -2 Black -3 Silver 201.17/set

Å

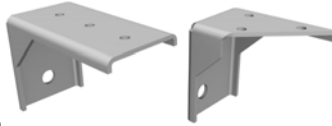

**Desk mount for desk booth, package**  
To be mounted with screws under the desk.  
2 desk mount and 4 corner desk mount.  
641069-1 White -2 Black -3 Silver 143.30/set

Ä



**Desk mount Mini to the desk booth, package**  
Assembled with screws under the desk.  
4 brackets are included. 2 Mini desk mounts  
and 2 Slim corner mounts.  
642027-1White -2 Black -3 Silver 104.57/set

Ö

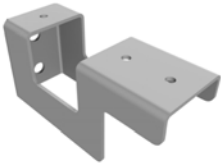

**Desk mount with recess for a beam**  
To be mounted with screws under the desk.  
2 pcs in one pack.  
642042-1White -2 Black -3 Silver 58.83/set

AA



**Desk mount Slim**  
To be mounted with screws under the desk.  
2 pcs in one pack. Right and left.  
642010-1White -2 Black -3 Silver 55.21/set

BB



**Desk mount Slim, two screens**  
Mounted with screws under the desk.  
3 mounts included: 1 pc right, 1 pc left,  
1 pc Slim corner mount.  
642020-1White 79.89/set

CC



**Desk mount Slim, three screens**  
Mounted with screws under the desk. 4 pcs  
mounts included: 1 pc right, 1 pc left,  
2 pc Slim corner mounts.  
642030-1 White 108.94/set

DD

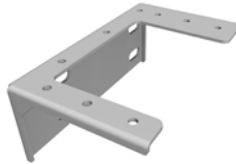

**Desk mount Slim reinforced**  
To be mounted with screws under the desk.  
2 pcs in one pack. Right and left.  
643010-1 White-2 Black -3 Silver 64.36/set

EE



**Desk mount for ScreenIT for angled desk sides**  
To be mounted with screws under the desk,  
2 pcs in one pack.  
642075-1 White-2 Black -3 Silver 57.34/set

**Desk mount for ScreenIT for angled desk sides, 3 pack**  
To be mounted with screws under the desk,  
3 pcs in one pack.  
642085-1 White-2 Black -3 Silver 88.40/set

GG



**Desk clamp for A30 above desk**  
For up to 42 mm desks.  
Content: 2 desk clamp and 2 pins.  
642090-1 White -2 Black -3 Silver 78.72/set

HH



**Desk clamp Small for A30 above desk**  
For up to 42 mm desks.  
Content: 2 desk clamp and 2 pins.  
642088-1 White-2 Black -3 Silver 63.30/set

II



**Pin for A30 above desk**  
Content 2 pins. Can be screwed above  
and below desks. When mounted under a  
desk, two 10 mm holes are drilled through  
the desk top.  
642095-1 White -2 Black -3 Silver 28.19/set

JJ



**Pins for A30 above desk, completion**  
Content 2 pins. Can be screwed above  
and below desks. When mounted under a  
desk, two 10 mm holes are drilled  
through the desk top.  
642089-1 White -2 Black -3 Silver 28.19/set



KK



**Foot for A30 above desk**

Content 2 pins with circular foot, Ø105 mm. Standing on the desk. Felt pads included.

642093-1 White -2 Black -3 Silver 49.79/set

LL



**Foot set for A30 Floor screen**

4 in one pack. Approx. 25 mm between floor and bottom of the floor screen.

641040-1 White -2 Black -3 Silver 76.81

**Foot Set Big for A30 Floor screen**

4 in one pack. About 60 mm between the floor and the bottom of the floor screen.

643070-1 White -2 Black -3 Silver 76.81

MM



**Corner foot set support for angled screens, A30**

4 in one pack. 3 standard and 1 angle.

641055-1 White -2 Black -3 Silver 76.81

NN



**Foot Set with wheels for A30 Floor screen**

Lockable wheels. 4 in one pack. Approx. 45 mm between floor and bottom of screen.

641066-1 White -2 Black -3 Silver 136.06

OO

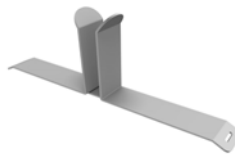

**Foot set Slide-in for A30 Floor screen without hole**

2 pcs in one pack.

641075-1 White -2 Black -3 Silver 120.85/set

PP



**Desk clamp/corner mount for two screens**

For up to 42 mm desks. 4 clamps includes. 2 clamps and 2 corner clamps.

641076-1 White -2 Black -3 Silver 110.32/set

QQ



**Foot set Woodland for Floorscreen A30**

Foot in molded wood with whitewashed ash veneer and metal fittings that fit A30 floor screen. 4 feet included.

643068-1 White\*/whitewashed ash 257.98  
643068-2 Black\*/whitewashed ash 257.98  
643068-3 Silver\*/whitewashed ash 257.98

\* Color indicates fittings.

SS



**Foot set Woodland with wheels for Floorscreen A30**

Foot set in molded wood with whitewashed ash veneer and metal fittings that fits A30 floor screen. 4 feet with wheels included. The wheels are lockable.

643067-1 White\*/whitewashed ash 335.43  
643067-2 Black\*/whitewashed ash 335.43  
643067-3 Silver\*/whitewashed ash 335.43

\* Color indicates wheels and fittings.

RR



**Foot set Woodland for A40/Sketch Floorscreen**

Foot in molded wood with whitewashed ash veneer and metal fittings that fit Sketch / A40 floor screen. 4 feet included.

643066-1 White\*/whitewashed ash 257.98  
643066-2 Black\*/whitewashed ash 257.98  
643066-3 Silver\*/whitewashed ash 257.98

\* Color indicates fittings.

TT



**Foot Set Slide-in Woodland with wheels for A40/Sketch Floor screen**

Foot set in molded wood with whitewashed ash veneer and metal fittings that fits Sketch/A40 floor screen. 4 feet with wheels included. The wheels are lockable.

643065-1 White\*/whitewashed ash 335.43  
643065-2 Black\*/whitewashed ash 335.43  
643065-3 Silver\*/whitewashed ash 335.43

\* Color indicates wheels and fittings.

UU



**Clamp set for desk screen for angled edge desks**

For up to 42 mm desks. 2 pcs in one pack. Not suitable for reinforced screens.

643015-1 White -2 Black -3 Silver 55.21/set

**Clamp set for desk screen for angled edge desks longer than 1800 mm**

For up to 42 mm desks. 3 pcs in one pack. Not suitable for reinforced screens.

643016-1 White -2 Black -3 Silver 82.66/set

VV



**Adjustable height screen mount set**

Height adjustable 280 mm. To be ordered with mount or clamp. 2 pcs in one pack.

641059-3 Silver 45.21/set

**Adjustable height screen mount set longer than 1800 mm**

Height adjustable 280 mm. To be ordered with mount or clamp. 3 pcs in one pack.

641060-3 Silver 67.66/set

# COMPARE SCREENS



## ScreenIT Standard

The most competitive priced screen with a solid core and foam laminated textile. Transmission effectiveness, meaning no noise penetration. Total thickness 20 mm. Max load 6 kg.

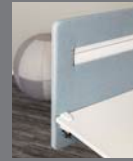

## ScreenIT A30 with built in rail

Reinforced A30 with a built in toolbar. Takes up to 25 kg in accessories, monitors etc.



## ScreenIT A30

Wooden frame filled with sound absorbing anti-allergy foam and lined with foam laminated textile. Total thickness 40 mm. Max load 6 kg.



## ScreenIT AT40

AT40 is made of a solid wood core with A-classed sound absorbing material on both sides. Total thickness 40 mm.



## ScreenIT A30 Flexible/Wall

As ScreenIT A30 without holes. Can be used as a desk or floor screen or wall mounted.



## ScreenIT Plexi

Desk screen made of acrylic plastic (plexi). Available in frosted, smoked, transparent.



## ScreenIT A30 Reinforced

A wooden reinforced screen filled with sound absorbing material, pin able and with foam laminated textile. 40 mm thick. Takes up to 25 kg in accessories, monitors etc.



## Peak Desk screen booth

Desk screen solution with a slight tilted side screen. Material like ScreenIT A30.



## ScreenIT A40

Material as A30 but with a thicker absorber. Total thickness 50 mm.



## ScreenIT A30 Desk booth / ScreenIT A30

Above desk Screen and side screens zipped together in the corners. Material like ScreenIT A30.



## Silent Express

Silent Express is a stocked screen. Total thickness: 32 mm. Max load: 0 kg.

*Read more and compare our Floor screens och Floor Screen Booths in the Floor Screen Chapter.*

# DESK SCREENS AND BOOTHS

An easy way to create a personal space and privacy, even in the most open office landscape. Our desk screens and booths protect you from both sound and visual distractions while their colour and shape contribute to a creative and productive environment. Several screens and textiles are Swan labeled in combination with each other. See the specification below. For more information regarding textiles, see page 6-16.

## ORDER PROCEDURE

### DESK SCREENS

1. SELECT SCREEN AND SCREEN SIZE
2. SELECT TEXTILE COLOUR  
See colour map at page 6-16.
3. SELECT ZIP OR SEAM COLOUR  
See colours on page 17.
4. SELECT CLAMPS OR MOUNTS  
See page 22-25.

Specify the article number as follows:  
Desk screen size - textile colour - zip/seam colour.  
Example: 644140 - 01 - 101.

Below screens and textiles are Nordic Eco labeled in combination with each other.

#### SCREENS

ScreenIT A30 Desk screen  
Silent Express

#### TEXTILE

Bond  
Cara  
Mica  
Rivet



Applies in combination with desk mount in white and black.

For updated information, see [www.gotessons.com](http://www.gotessons.com)

### DESK SCREEN BOOTH

1. SELECT SCREEN AND SCREEN SIZE
2. SELECT TEXTILE COLOUR  
See colour map at page 6-16.
3. SELECT SEAM COLOUR ON SCREEN  
See colours on page 17.
4. SELECT ZIP TO CONNECT SCREENS  
See colours on page 17.
5. SELECT CLAMPS OR MOUNTS  
See page 22-25.

Specify the article number as follows:  
Screen booth - textile colour - seam colour - zip colour.  
Example: 1178160 - 14 - 206 - 101.



ScreenIT A30 with magnets is developed to create a quick and easy assembly using magnets. The product is intended to be used on duo tables with beams as a frame. You attach the screen between the table tops to get a practical screen.



## SCREENIT A30 FOR MAGNETS

### ScreenIT A30 650 mm

See price ranges in textile chapter.

With seam	Pricer. 1	Pricer. 2	Pricer. 3	Pricer. 4
6430140- W. 1400 H. 650	286,70	313,30	398,40	504,79
6430160- W. 1600 H. 650	302,66	339,89	419,68	536,70
6430180- W. 1800 H. 650	355,85	419,68	504,79	621,81

### ScreenIT A30 800 mm

With seam	Pricer. 1	Pricer. 2	Pricer. 3	Pricer. 4
675140- W. 1400 H. 800	334,57	387,77	648,40	823,94
675160- W. 1600 H. 800	345,00	435,64	706,91	893,09
675180- W. 1800 H. 800	425,00	504,79	829,26	999,47

### Magnet mount for A30 for magnets

Mounted with screws in the screen. 2 mounts included.

Magnet effect: 87 kg/piece. Ø 48 mm..

643017-1	white	57.98
643017-2	black	57.98
643017-3	silver	57.98

### Technical information

2 magnets were attached to screen with bracket 643017.

The bracket sits 53.5 mm from the outer edge of the screen.

The power of the magnets: 87 kg/pc. Placed on the metal beam of the desk. Dimensions of the screen above the desk depend on the position of the beam.

The customer needs to measure the CC measurement between the centers of each beam. The magnet is Ø 48 mm. To maximize the use of the magnet's power, the entire magnet should be in contact with the beam, which means that the beam should be at least 50 mm wide. The screen can only be ordered with a seam.

There are three different standard dimensions:

	CC measurement between beams
ScreenIT A30 W: 1400	1293
ScreenIT A30 W: 1600	1493
ScreenIT A30 W: 1800	1693

If your table has other dimensions, contact Götessons.

**Order procedure desk screen, see page 27.**



The screen is developed to maximize sound absorption. It has a wooden frame filled with 30 mm sound absorbing material and is coated with a foam laminated textile. It is also possible to use as pinboard. Max load 6 kg. Total thickness 40 mm. For A30 Reinforced or A30 with built in rail.



## SCREENIT A30 P1 AND A30 K DESK SCREEN

A30 P1 and A30 K have the same features as the A30, for details see above. The difference is the measurement from the outer edge to the bolt hole. A30 = 45 mm, A30 P1 = 150 mm and A30 K = 250 mm from the outer edge. Article numbers in column beside is for ScreenIT A30, if you want to order A30 P1 or A30 K, please contact Götessons.

## SCREENIT A30

ScreenIT A30 Desk Screen 650 mm *See price ranges in textile chapter.*

With seam	Pricer. 1	Pricer. 2	Pricer. 3	Pricer. 4
642960- W. 600 H. 650	170,53	186,17	212,02	265,00
642970- W. 700 H. 650	175,54	189,79	252,98	303,62
643080- W. 800 H. 650	183,40	192,77	338,83	443,30
643120- W. 1200 H. 650	245,85	276,91	398,83	505,74
643140- W. 1400 H. 650	252,98	289,36	405,74	512,87
643160- W. 1600 H. 650	255,96	302,02	408,62	515,74
643180- W. 1800 H. 650	292,77	347,77	444,04	552,98
643200- W. 2000 H. 650	374,26	406,28	522,02	633,83

With zip	Pricer. 1	Pricer. 2	Pricer. 3	Pricer. 4
642960- W. 600 H. 650	195,53	210,96	236,17	289,68
642970- W. 700 H. 650	204,79	216,49	274,36	330,21
643080- W. 800 H. 650	227,02	236,81	380,53	486,81
643120- W. 1200 H. 650	289,36	320,96	440,64	549,15
643140- W. 1400 H. 650	296,60	333,40	447,45	556,49
643160- W. 1600 H. 650	299,47	346,06	450,32	559,26
643180- W. 1800 H. 650	336,60	391,81	486,06	596,60
643200- W. 2000 H. 650	417,55	450,43	550,43	677,45

ScreenIT A30 Desk Screen 800 mm

With seam	Pricer. 1	Pricer. 2	Pricer. 3	Pricer. 4
664060- W. 600 H. 800	177,55	192,87	218,83	271,60
664070- W. 700 H. 800	217,56	227,45	346,17	409,79
664080- W. 800 H. 800	253,83	267,23	448,51	667,02
664120- W. 1200 H. 800	316,17	330,00	535,64	702,66
664140- W. 1400 H. 800	323,40	364,15	632,45	802,13
664160- W. 1600 H. 800	326,28	397,77	692,87	873,30
664180- W. 1800 H. 800	363,30	435,32	770,74	944,68
664200- W. 2000 H. 800	444,47	471,38	825,53	1072,77

With zip	Pricer. 1	Pricer. 2	Pricer. 3	Pricer. 4
664060- W. 600 H. 800	202,13	217,66	242,45	296,06
664070- W. 700 H. 800	258,62	279,69	385,96	459,68
664080- W. 800 H. 800	297,45	311,06	490,43	710,43
664120- W. 1200 H. 800	359,57	373,83	577,34	746,28
664140- W. 1400 H. 800	366,91	408,09	674,26	845,64
664160- W. 1600 H. 800	369,89	441,60	734,68	917,02
664180- W. 1800 H. 800	406,91	479,26	812,66	988,19
664200- W. 2000 H. 800	487,98	515,43	867,23	1116,28

Facts: Desk thickness 20 mm applies to following measures. Screens H:650 mm: Clamp = H:450 mm above desk. Deskmount = H:430 mm above desk. Screens H:800 mm: Clamp = H:600 mm above desk. Deskmount = H:580 mm above desk. Max load 6 kg.

## SCREENIT A30 STRAIGHT CORNERS

ScreenIT A30 650 mm *See price ranges in textile chapter.*

With seam	Pricer. 1	Pricer. 2	Pricer. 3	Pricer. 4
543080- W. 800 H. 650	183,40	192,77	338,83	443,30
543120- W. 1200 H. 650	245,85	276,91	398,83	505,74
543140- W. 1400 H. 650	252,98	289,36	405,74	512,87
543160- W. 1600 H. 650	255,96	302,02	408,62	515,74
543180- W. 1800 H. 650	292,77	347,77	444,04	552,98
543200- W. 2000 H. 650	374,26	406,28	522,02	633,83

With seam	Pricer. 1	Pricer. 2	Pricer. 3	Pricer. 4
564080- W. 800 H. 800	253,83	267,23	448,51	667,02
564120- W. 1200 H. 800	316,17	330,00	535,64	702,66
564140- W. 1400 H. 800	323,40	364,15	632,45	802,13
564160- W. 1600 H. 800	326,28	397,77	692,87	873,30
564180- W. 1800 H. 800	363,30	435,32	770,74	944,68
564200- W. 2000 H. 800	444,47	471,38	825,53	1072,77

Facts: Desk thickness 20 mm applies to following measures. Screens H:650 mm: Clamp = H:450 mm above desk. Deskmount = H:430 mm above desk. Screens H:800 mm: Clamp = H:600 mm above desk. Deskmount = H:580 mm above desk. Max load 6 kg.

The brackets below fit the above items.

See all mounts on pages 22-25.

(A)	(B)	(C)	(D)	(E)	(F)
641010	641025	641050	641045	643047	643046
641056	641035				
(G)	(H)	(EE)	(UU)		
641020	641058	642075	643015		
641057		642085	643016		

Order procedure desk screen, see page 27.



This screen is the same as a regular A30, but the dimensions above the table are 500 mm. A requested product to get extra shielding.

## SCREENIT A30 500 MM ABOVE DESK

### ScreenIT A30 650 mm

See price ranges in textile chapter.

			Pricer. 1	Pricer. 2	Pricer. 3	Pricer. 4
<b>With seam</b>						
6429605-	W. 600	H. 650	170,53	186,17	212,02	265,00
6429705-	W. 700	H. 650	175,54	189,79	252,98	303,62
6430805-	W. 800	H. 650	183,40	192,77	338,83	443,30
6431205-	W. 1200	H. 650	245,85	276,91	398,83	505,74
6431405-	W. 1400	H. 650	252,98	289,36	405,74	512,87
6431605-	W. 1600	H. 650	255,96	302,02	408,62	515,74
6431805-	W. 1800	H. 650	292,77	347,77	444,04	552,98
6432005-	W. 2000	H. 650	374,26	406,28	522,02	633,83
<b>With zip</b>						
6429605-	W. 600	H. 650	195,53	210,96	236,17	289,68
6429705-	W. 700	H. 650	204,79	216,49	274,36	330,21
6430805-	W. 800	H. 650	227,02	236,81	380,53	486,81
6431205-	W. 1200	H. 650	289,36	320,96	440,64	549,15
6431405-	W. 1400	H. 650	296,60	333,40	447,45	556,49
6431605-	W. 1600	H. 650	299,47	346,06	450,32	559,26
6431805-	W. 1800	H. 650	336,60	391,81	486,06	596,60
6432005-	W. 2000	H. 650	417,55	450,43	550,43	677,45

Important info: Standard dimensions above desk with table top 20 mm: clamp clamp 520 mm, desk mount 500 mm. Maximum load 6 kg.

The brackets below fit the above items.  
See all mounts on pages 22-25.

(A)	(B)	(C)	(D)	(E)	(F)
641010	641025	641050	641045	643047	643046
641056	641035				
(G)	(H)	(EE)	(JJ)		
641020	641058	642075	643015		
641057		642085	643016		

Order procedure desk screen, see page 27.



The screen can be used as a desk, floor and wall screen. This screen is without holes and can be ordered with height adjustable mounting brackets. The screen can then easily be moved up and down with an Allen key. See video on [www.gotessons.com](http://www.gotessons.com).



## SCREENIT A30 FLEXIBLE

### ScreenIT A30 Flexible 650 mm, zipper on long side

See price ranges in textile chapter.

With seam	Pricer. 1	Pricer. 2	Pricer. 3	Pricer. 4
627080- W. 800 H. 650	183,40	192,77	338,83	443,30
627120- W. 1200H. 650	245,85	276,91	398,83	505,74
627140- W. 1400H. 650	252,98	289,36	405,74	512,87
627160- W. 1600H. 650	255,96	302,02	408,62	515,74
627180- W. 1800H. 650	292,77	347,77	444,04	552,98
627200- W. 2000H. 650	374,26	406,28	522,02	633,83
With zip				
627080- W. 800 H. 650	227,02	236,81	380,53	486,81
627120- W. 1200H. 650	289,36	320,96	440,64	549,15
627140- W. 1400H. 650	296,60	333,40	447,45	556,49
627160- W. 1600H. 650	299,47	346,06	450,32	559,26
627180- W. 1800H. 650	336,60	391,81	486,06	596,60
627200- W. 2000H. 650	417,55	450,43	550,43	677,45

### ScreenIT A30 Flexible 800 mm, zipper on long side

With seam				
625080- W. 800 H. 800	253,83	267,23	448,51	667,02
625120- W. 1200H. 800	316,17	330,00	535,64	702,66
625140- W. 1400H. 800	323,40	364,15	632,45	802,13
625160- W. 1600H. 800	326,28	397,77	692,87	873,30
625180- W. 1800H. 800	363,30	435,32	770,74	944,68
625200- W. 2000H. 800	444,47	471,38	825,53	1072,77
With zip				
625080- W. 800 H. 800	297,45	311,06	490,43	710,43
625120- W. 1200H. 800	359,57	373,83	577,34	746,28
625140- W. 1400H. 800	366,91	408,09	674,26	845,64
625160- W. 1600H. 800	369,89	441,60	734,68	917,02
625180- W. 1800H. 800	406,91	479,26	812,66	988,19
625200- W. 2000H. 800	487,98	515,43	867,23	1116,28

### ScreenIT A30 Flexible 650 mm, zipper on short side

With seam				
623080- W. 650 H. 800	183,40	192,77	338,83	443,30
623120- W. 650 H. 1200	245,85	276,91	398,83	505,74
623140- W. 650 H. 1400	252,98	289,36	405,74	512,87
623160- W. 650 H. 1600	255,96	302,02	408,62	515,74
623180- W. 650 H. 1800	292,77	347,77	444,04	552,98
623200- W. 650 H. 2000	374,26	406,28	522,02	633,83
With zip				
623080- W. 650 H. 800	227,02	236,81	380,53	486,81
623120- W. 650 H. 1200	289,36	320,96	440,64	549,15
623140- W. 650 H. 1400	296,60	333,40	447,45	556,49
623160- W. 650 H. 1600	299,47	346,06	450,32	559,26
623180- W. 650 H. 1800	336,60	391,81	486,06	596,60
623200- W. 650 H. 2000	417,55	450,43	550,43	677,45

### ScreenIT A30 Flexible 800 mm, zipper on short side

With seam				
624080- W. 800 H. 800	253,83	267,23	448,51	667,02
624120- W. 800 H. 1200	316,17	330,00	535,64	702,66
624140- W. 800 H. 1400	323,40	364,15	632,45	802,13
624160- W. 800 H. 1600	326,28	397,77	692,87	873,30
624180- W. 800 H. 1800	363,30	435,32	770,74	944,68
624200- W. 800 H. 2000	444,36	471,38	825,53	1072,77
With zip				
624080- W. 800 H. 800	297,45	311,06	490,43	710,43
624120- W. 800 H. 1200	359,57	373,83	577,34	746,28
624140- W. 800 H. 1400	366,91	408,09	674,26	845,64
624160- W. 800 H. 1600	369,89	441,60	734,68	917,02
624180- W. 800 H. 1800	406,91	479,26	812,66	988,19
624200- W. 800 H. 2000	487,87	515,43	867,23	1116,28

Order procedure desk screen, see page 27.

The brackets below fit the above items.  
See all mounts on pages 22-25.



641085 642032 642033 642043 641075

#### Wall package

List for wall mount.

641063	500 mm	22.66
641064	1000 mm (for screens longer than 1800 mm)	42.77



The tremendously popular sound absorbing screen A30 is also available as a reinforced model that allows for weights of up to 25 kg. Ideal for hanging up tool arms and other accessories.

## SCREENIT A30 REINFORCED

ScreenIT A30 Reinforced 650 mm *See price ranges in textile chapter.*

With seam			Pricer. 1	Pricer. 2	Pricer. 3	Pricer. 4
648080-	W. 800	H. 650	270,32	278,30	414,89	522,34
648120-	W. 1200	H. 650	332,87	363,19	473,09	583,30
648140-	W. 1400	H. 650	340,00	376,06	479,89	590,11
648160-	W. 1600	H. 650	342,77	388,72	482,66	592,77
648180-	W. 1800	H. 650	380,11	434,79	517,23	628,83
648200-	W. 2000	H. 650	450,21	482,23	582,66	697,02

With zip			Pricer. 1	Pricer. 2	Pricer. 3	Pricer. 4
648080-	W. 800	H. 650	315,21	323,83	456,60	566,17
648120-	W. 1200	H. 650	377,55	408,30	514,79	626,38
648140-	W. 1400	H. 650	384,79	421,28	521,70	633,51
648160-	W. 1600	H. 650	387,55	434,15	524,47	636,49
648180-	W. 1800	H. 650	424,57	480,11	558,83	672,13
648200-	W. 2000	H. 650	495,00	527,45	624,68	740,53

ScreenIT A30 Reinforced 800 mm

With seam			Pricer. 1	Pricer. 2	Pricer. 3	Pricer. 4
1049080-	W. 800	H. 800	340,53	355,00	522,23	743,94
1049120-	W. 1200	H. 800	402,77	417,98	607,66	777,87
1049140-	W. 1400	H. 800	410,11	452,87	704,47	877,23
1049160-	W. 1600	H. 800	413,30	487,23	764,68	948,19
1049180-	W. 1800	H. 800	450,11	525,00	841,60	1018,19
1049200-	W. 2000	H. 800	520,96	549,15	884,36	1133,94

With zip			Pricer. 1	Pricer. 2	Pricer. 3	Pricer. 4
1049080-	W. 800	H. 800	385,53	400,43	564,15	787,23
1049120-	W. 1200	H. 800	447,77	463,09	649,57	821,38
1049140-	W. 1400	H. 800	455,11	497,98	746,17	920,53
1049160-	W. 1600	H. 800	457,87	532,34	806,60	991,49
1049180-	W. 1800	H. 800	495,00	570,00	883,30	1061,81
1049200-	W. 2000	H. 800	565,64	594,47	926,28	1177,55

Facts: Max load 25 kg. Total screen thickness 40 mm.

Desk thickness 20 mm applies to following measures.

Screens H:650 mm: Deskmount = H:430 mm above desk.

Screens H:800 mm: Deskmount = H:580 mm above desk.

The brackets below fit the above items.

See all mounts on pages 22-25.



641020 642034 642075  
641057 642036 642085  
642046

Order procedure desk screen, see page 27.





A40 is constructed with a wooden frame filled with 40 mm sound absorbing materials and foam laminated textile for a good sound absorption. Choose from a variety of textiles and combine with seam or zipper. Total thickness 50 mm.

## SCREENIT A40

### ScreenIT A40 Desk Screen 650 mm

#### With seam

1043080- W. 800 H. 650	194,47	198,51	348,94	456,60
1043120- W. 1200 H. 650	260,74	285,21	410,74	520,85
1043140- W. 1400 H. 650	268,19	298,09	417,87	528,19
1043160- W. 1600 H. 650	271,60	311,06	420,85	531,28
1043180- W. 1800 H. 650	310,85	358,19	457,45	569,47
1043200- W. 2000 H. 650	396,91	418,51	537,77	652,87

#### With zip

1043080- W. 800 H. 650	240,96	245,11	392,13	501,49
1043120- W. 1200 H. 650	306,91	331,70	453,83	565,96
1043140- W. 1400 H. 650	314,47	344,68	460,96	573,09
1043160- W. 1600 H. 650	317,55	357,55	464,04	575,96
1043180- W. 1800 H. 650	356,91	404,89	500,64	614,15
1043200- W. 2000 H. 650	442,87	465,11	566,91	697,55

### ScreenIT A40 Desk Screen 800 mm

#### With seam

1064080- W. 800 H. 800	269,47	285,74	461,91	687,02
1064120- W. 1200 H. 800	335,53	352,23	551,81	724,04
1064140- W. 1400 H. 800	342,87	388,72	651,49	826,28
1064160- W. 1600 H. 800	346,28	424,15	713,51	899,57
1064180- W. 1800 H. 800	385,64	464,15	793,83	973,09
1064200- W. 2000 H. 800	471,60	502,02	850,21	1104,89

#### With zip

1064080- W. 800 H. 800	330,21	359,36	505,11	731,81
1064120- W. 1200 H. 800	381,49	398,83	594,79	768,83
1064140- W. 1400 H. 800	389,36	435,21	694,47	871,17
1064160- W. 1600 H. 800	392,45	470,74	756,60	944,47
1064180- W. 1800 H. 800	431,49	510,53	837,02	1017,66
1064200- W. 2000 H. 800	517,66	548,40	893,30	1149,79

Facts: Standard height from desk top 450 mm with clamp.  
With desk mount 430 mm if desk is 20 mm. Max load 6 kg.

The brackets below fit the above items.

See all mounts on pages 22-25.

(A)	(B)	(C)	(D)	(E)	(F)
641010	641025	641050	641045	643047	643046
641056	641035				
(G)	(H)	(EE)	(UU)		
641020	641058	642075	643015		
641057		642085	643016		

Order procedure desk screen, see page 27.



As ScreenIT A30/A40 but with a built in toolbar rail as opposed to screwed on.  
 Thickness: A30=40 mm. A40=50 mm. Can also be ordered with silver rail to the same price, to order start the article number with 10 instead of 11. Ex.1040080 instead of 1140080.

Can be ordered with other measurement from outer edge to bolt hole: e.g. A30 P1=150mm or A30 K=250mm. Contact Gotessons for article number and price.



This screen is the same as a regular A30, but the dimensions above the table are 500 mm.  
 A requested product to get extra shielding.

## SCREENIT A30 WITH BUILT IN RAIL

### ScreenIT A30 with built in rail 650 mm, white

See price ranges in textile chapter.



A30 with seam	Pricer. 1	Pricer. 2	Pricer. 3	Pricer. 4
1140080- W. 800 H. 650	347,77	368,62	417,77	508,40
1140120- W. 1200 H. 650	447,55	468,51	517,23	684,89
1140140- W. 1400 H. 650	481,06	508,19	592,55	749,89
1140160- W. 1600 H. 650	521,06	547,13	640,11	860,96
1140180- W. 1800 H. 650	586,38	620,32	697,66	944,79
1140200- W. 2000 H. 650	634,15	678,94	765,96	1039,15
<b>With zip</b>				
1140080- W. 800 H. 650	391,38	412,55	458,62	550,74
1140120- W. 1200 H. 650	491,17	512,55	557,87	727,34
1140140- W. 1400 H. 650	524,68	552,23	633,09	792,23
1140160- W. 1600 H. 650	564,57	591,28	680,96	903,51
1140180- W. 1800 H. 650	629,79	664,15	738,40	987,23
1140200- W. 2000 H. 650	677,66	722,98	806,70	1081,38

### ScreenIT A30 with built in rail 800 mm, white

With seam	Pricer. 1	Pricer. 2	Pricer. 3	Pricer. 4
1170080- W. 800 H. 800	385,74	393,94	582,87	767,45
1170120- W. 1200 H. 800	477,13	508,40	635,96	835,53
1170140- W. 1400 H. 800	524,26	540,85	800,53	1035,53
1170160- W. 1600 H. 800	606,17	618,83	978,40	1317,23
1170180- W. 1800 H. 800	655,96	668,51	1081,17	1471,70
1170200- W. 2000 H. 800	718,51	732,98	1197,02	1652,34
<b>With zip</b>				
1170080- W. 800 H. 800	429,26	438,19	623,72	810,21
1170120- W. 1200 H. 800	520,96	552,45	676,49	877,98
1170140- W. 1400 H. 800	567,66	584,79	841,28	1077,98
1170160- W. 1600 H. 800	649,89	662,98	1019,15	1359,57
1170180- W. 1800 H. 800	699,57	712,55	1121,91	1514,15
1170200- W. 2000 H. 800	762,45	777,02	1237,87	1695,00

## SCREENIT A30 WITH BUILT IN RAIL

500 MM ABOVE DESK

### ScreenIT A30 desk screen 650 mm, white

See price ranges in textile chapter.



With seam	Pricer. 1	Pricer. 2	Pricer. 3	Pricer. 4
11400805- W. 800 H. 650	347,77	368,62	417,77	508,40
11401205- W. 1200 H. 650	447,55	468,51	517,23	684,89
11401405- W. 1400 H. 650	481,06	508,19	592,55	749,89
11401605- W. 1600 H. 650	521,06	547,13	640,11	860,96
11401805- W. 1800 H. 650	586,38	620,32	697,66	944,79
11402005- W. 2000 H. 650	634,15	678,94	765,96	1039,15
<b>With zip</b>				
11400805- W. 800 H. 650	391,38	412,55	458,62	550,74
11401205- W. 1200 H. 650	491,17	512,55	557,87	727,34
11401405- W. 1400 H. 650	524,68	552,23	633,09	792,23
11401605- W. 1600 H. 650	564,57	591,28	680,96	903,51
11401805- W. 1800 H. 650	629,79	664,15	738,40	987,23
11402005- W. 2000 H. 650	677,66	722,98	806,70	1081,38

Important info: Standard dimensions above desk with table top 20 mm:  
 clamp clamp 520 mm, desk mount 500 mm. Maximum load 25 kg.

The brackets below fit the above items.

See all mounts on pages 22-25.



641020 642034 642075  
 641057 642036 642085  
 642046



## SCREENIT A40 WITH BUILT IN RAIL

ScreenIT A40 with built in rail 650 mm, white  
*See price ranges in textile chapter.*



A40 with seam	Pricer. 1	Pricer. 2	Pricer. 3	Pricer. 4
1145080- W. 800 H. 650	358,19	379,57	430,32	523,51
1145120- W. 1200H. 650	460,96	482,55	532,55	705,53
1145140- W. 1400H. 650	495,53	523,30	610,21	772,34
1145160- W. 1600H. 650	536,70	563,40	659,36	886,81
1145180- W. 1800H. 650	603,72	638,40	718,51	973,19
1145200- W. 2000H. 650	652,87	699,26	788,94	1070,32
A40 with zip				
1145080- W. 800 H. 650	401,81	423,72	471,06	566,17
1145120- W. 1200 H. 650	504,57	526,60	573,62	747,87
1145140- W. 1400 H. 650	539,04	567,55	650,96	814,79
1145160- W. 1600 H. 650	580,43	607,45	700,11	929,26
1145180- W. 1800 H. 650	647,55	682,77	759,26	1015,43
1145200- W. 2000 H. 650	696,70	743,51	829,68	1112,55

ScreenIT A40 with built in rail 800 mm, white

With seam				
1180080- W. 800 H. 800	397,13	405,74	600,53	790,74
1180120- W. 1200H. 800	491,60	523,62	654,89	860,64
1180140- W. 1400H. 800	540,00	557,13	824,47	1066,60
1180160- W. 1600H. 800	624,36	637,55	1007,77	1356,81
1180180- W. 1800H. 800	675,53	688,40	1113,51	1515,85
1180200- W. 2000H. 800	740,21	754,89	1232,87	1702,13
With zip				
1180080- W. 800 H. 800	440,85	450,11	641,28	833,19
1180120- W. 1200H. 800	535,21	567,87	695,43	903,19
1180140- W. 1400H. 800	583,62	601,28	865,21	1109,04
1180160- W. 1600H. 800	668,19	681,60	1048,51	1399,15
1180180- W. 1800H. 800	719,26	732,45	1154,36	1558,30
1180200- W. 2000H. 800	783,94	798,94	1273,83	1744,47

Order procedure desk screen, see page 27.

The brackets below fit the above items.  
 See all mounts on pages 22-25.



641020 642034 642075  
 641057 642036 642085  
 642046



AT40 is a sound dampening desk screen. AT = Absorption and Transmission. The screen has a solid core and with a 10 mm A-classed sound absorbent on each side, covered by a foam laminated textile of your choice. Total thickness 40 mm. AT40 is also available with height 800 mm. Contact Gotessons for article number and price.

## SCREENIT AT40

### ScreenIT AT40

See price ranges in textile chapter.

With seam			Pricer. 1	Pricer. 2	Pricer. 3	Pricer. 4
626080-	W. 800	H. 650	217,55	248,40	367,98	474,79
626120-	W. 1200	H. 650	293,72	343,09	439,15	548,72
626140-	W. 1400	H. 650	324,47	378,62	467,34	578,40
626160-	W. 1600	H. 650	365,96	426,49	506,38	618,94
626180-	W. 1800	H. 650	399,04	466,06	537,34	650,85
626200-	W. 2000	H. 650	436,91	510,32	572,55	687,77
With zip						
626080-	W. 800	H. 650	263,09	294,36	410,43	518,94
626120-	W. 1200	H. 650	339,26	389,26	481,60	593,09
626140-	W. 1400	H. 650	369,47	424,57	509,89	622,55
626160-	W. 1600	H. 650	411,49	472,45	548,72	662,87
626180-	W. 1800	H. 650	444,68	512,13	579,89	695,21
626200-	W. 2000	H. 650	482,34	556,28	615,00	732,02

### Order procedure desk screen, see page 27.

Facts: Standard height from desk top 450 mm with clamp.  
With desk mount 430 mm if desk is 20 mm. Max load 6 kg.

The brackets below fit the above items.

See all mounts on pages 22-25.

(A)	(B)	(E)	(F)	(G)	(X)	(EE)	(UU)
641010	641025	643047	643046	641020	642034	642075	643015
641056	641035			641057	642036	642085	643016
					642046		



A smaller AT40 desk screen that is easy to place above desk with a special made desk mount. Also as dividing screens in bench systems, see page 37+39 or [www.gotessons.com](http://www.gotessons.com).

## SCREENIT AT40 ABOVE DESK

### ScreenIT AT40 above desk

See price ranges in textile chapter.

With seam			Pricer. 1	Pricer. 2	Pricer. 3	Pricer. 4
621760-	W. 760	H. 450	210,85	245,85	252,98	334,36
626800-	W. 800	H. 450	218,51	249,68	272,77	340,74
621200-	W. 1200H.	450	260,21	297,77	367,98	439,79
621400-	W. 1400H.	450	295,43	337,55	418,09	492,13
621600-	W. 1600H.	450	315,74	361,49	441,38	515,96
621800-	W. 1800H.	450	362,23	414,15	482,02	558,40
622000-	W. 2000H.	450	404,15	462,34	546,70	625,53
With zip						
621760-	W. 760	H. 450	256,06	291,49	295,32	378,19
626800-	W. 800	H. 450	264,04	295,53	315,21	384,68
621200-	W. 1200H.	450	305,64	338,19	410,43	483,94
621400-	W. 1400H.	450	341,06	383,19	460,74	536,28
621600-	W. 1600H.	450	361,28	411,81	483,72	560,43
621800-	W. 1800H.	450	407,87	466,28	524,57	602,55
622000-	W. 2000H.	450	449,68	515,32	589,15	669,89

### Clamp AT40 above desk

For up to 22 mm desks, 2 pcs in one pack.

642050-1 white -2 black -3 silver 55.21/2 pcs

### Clamp AT40 above desk longer than 1800 mm

For up to 22 mm desks, 3 pcs in one pack.

642070-1 white -2 black -3 silver 82.66/3 pcs

### Clamp AT40 above desk

For up to 50 mm desks, 2 pcs in one pack.

642060-1 white -2 black -3 silver 55.21/2 pcs

### Clamp AT40 above desk longer than 1800 mm

For up to 50 mm desks, 3 pcs in one pack.

642080-1 white -2 black -3 silver 82.66/3 pcs

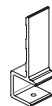



Desk screen made of acrylic. The screens are available in transparent, frosted and smoked plexi.

## SCREENIT PLEXI

### ScreenIT Plexi 5 mm

5 mm thick acryl desk screen. Standard height from desk top 450 mm (with desk clamp).

631080	W. 800	H. 650	transparent	143.09
631120	W. 1200	H. 650	transparent	189.15
631140	W. 1400	H. 650	transparent	228.51
631160	W. 1600	H. 650	transparent	241.60
631180	W. 1800	H. 650	transparent	261.28
633080	W. 800	H. 650	frosted	162.87
633120	W. 1200	H. 650	frosted	221.91
633140	W. 1400	H. 650	frosted	254.68
633160	W. 1600	H. 650	frosted	280.85
633180	W. 1800	H. 650	frosted	313.83
635080	W. 800	H. 650	smoked	215.21
635120	W. 1200	H. 650	smoked	294.15
635140	W. 1400	H. 650	smoked	340.00
635160	W. 1600	H. 650	smoked	379.47
635180	W. 1800	H. 650	smoked	418.83

### ScreenIT Plexi 8 mm

8 mm thick acryl desk screen. Standard height from desk top 450 mm (with desk clamp).

637080	W. 800	H. 650	transparent	208.83
637120	W. 1200	H. 650	transparent	280.85
637140	W. 1400	H. 650	transparent	320.32
637160	W. 1600	H. 650	transparent	340.00
637180	W. 1800	H. 650	transparent	372.87
638080	W. 800	H. 650	frosted	234.89
638120	W. 1200	H. 650	frosted	326.81
638140	W. 1400	H. 650	frosted	392.55
638160	W. 1600	H. 650	frosted	412.13
638180	W. 1800	H. 650	frosted	464.68
639080	W. 800	H. 650	smoked	307.13
639120	W. 1200	H. 650	smoked	438.51
639140	W. 1400	H. 650	smoked	497.55
639160	W. 1600	H. 650	smoked	563.09
639180	W. 1800	H. 650	smoked	615.64



Transparent



Frosted



Smoked



### Clamp set for ScreenIT Plexi, 2 pcs

For up to 42 mm desks. 2 pcs in one pack.

641080-1white	-2 black	-3 silver	57.02/2pcs
---------------	----------	-----------	------------

### Clamp set for ScreenIT Plexi longer than 1600 mm

For up to 42 mm desks, 3 pcs in one pack.

641081-1white	-2 black	-3 silver	86.06/3pcs
---------------	----------	-----------	------------



### Desk mount for ScreenIT Plexi

To be mounted with screws under the desk, 2 pcs in one pack.

641082-1white	-2 black	-3 silver	58.72/2pcs
---------------	----------	-----------	------------

### Desk mount for ScreenIT Plexi longer than 1600 mm

To be mounted with screws under the desk, 3 pcs in one pack.

641083-1white	-2 black	-3 silver	88.72/3pcs
---------------	----------	-----------	------------



### Desk mount set for Halfpipe with keyhole

To be mounted with screws under the desk, 2 pcs in one pack.

641084-1white	-3 silver	70.32/2pcs
---------------	-----------	------------

### Desk mount set for Halfpipe with keyhole, for ScreenIT Plexi longer than 1600 mm

To be mounted with screws under the desk, 3 pcs in one pack.

641086-1white	-3 silver	94.68/3pcs
---------------	-----------	------------



### Desk mount with recess for a beam for ScreenIT Plexi

To be mounted with screws under the desk, 2 pcs in one pack.

641087-1white	-2 black	-3 silver	62.34/2pcs
---------------	----------	-----------	------------

### Desk mount with recess for a beam for ScreenIT Plexi longer than 1600 mm

To be mounted with screws under the desk, 3 pcs in one pack.

641088-1white	-2 black	-3 silver	86.91/3pcs
---------------	----------	-----------	------------



Booth dividers connected with zipper. Side screens width is as standard 800 mm. Not available with fishbone zip. Contact us for other measurements.



## SCREENIT A30 BOOTH

ScreenIT A30 desk booth 650 mm *See price ranges in textile chapter.*

With seam+zip	Pricer. 1	Pricer. 2	Pricer. 3	Pricer. 4
855120- W. 1200 H. 650	764,04	812,23	1202,34	1512,55
855140- W. 1400 H. 650	770,85	819,15	1208,94	1519,26
855160- W. 1600 H. 650	773,72	822,02	1211,81	1522,13
855180- W. 1800 H. 650	809,26	857,98	1245,85	1557,87

ScreenIT A30 desk booth 800 mm







With seam+zip	Pricer. 1	Pricer. 2	Pricer. 3	Pricer. 4
1181120- W. 1200 H. 800	971,38	1012,23	1555,32	2148,19
1181140- W. 1400 H. 800	978,30	1045,64	1649,04	2244,36
1181160- W. 1600 H. 800	981,28	1077,66	1707,66	2313,62
1181180- W. 1800 H. 800	1017,23	1114,47	1783,19	2382,34

Order procedure desk screen, see page 27.

Facts: Desk thickness 20 mm applies to following measures.  
Screens H:650 mm: Clamp = H:450 mm above desk.  
Deskmount = H:430 mm above desk.  
Screens H:800 mm: Clamp = H:600 mm above desk.  
Deskmount = H:580 mm above desk.  
Max load 6 kg. Total screen thickness 40 mm.

The brackets below fit the above items.

See all mounts on pages 22-25.

					
641068	641071	641069	642027	642075	642075
				642085	642085

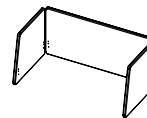

## PEAK DESK SCREEN BOOTH

Peak Desk Screen booth 650 mm *See price ranges in textile chapter.*

With seam+zip	Pricer. 1	Pricer. 2	Pricer. 3	Pricer. 4
108120- W. 1200 H. 650	926,70	984,79	1179,47	1483,72
108140- W. 1400 H. 650	934,57	993,19	1185,96	1490,32
108160- W. 1600 H. 650	938,09	996,81	1188,72	1493,19
108180- W. 1800 H. 650	981,17	1040,32	1222,13	1527,98

Peak Desk Screen booth 800 mm







With seam+zip	Pricer. 1	Pricer. 2	Pricer. 3	Pricer. 4
109120- W. 1200 H. 800	1147,23	1251,28	1555,53	2148,19
109140- W. 1400 H. 800	1175,64	1292,45	1649,04	2244,36
109160- W. 1600 H. 800	1213,62	1332,13	1707,66	2313,62
109180- W. 1800 H. 800	1239,47	1377,55	1783,19	2382,34

Order procedure desk screen, see page 27.

Facts: Desk thickness 20 mm applies to following measures.  
Screens H:650 mm: Clamp = H:450 mm above desk.  
Deskmount = H:430 mm above desk.  
Screens H:800 mm: Clamp = H:600 mm above desk.  
Deskmount = H:580 mm above desk.  
Max load 6 kg. Total screen thickness 40 mm.

The brackets below fit the above items.

See all mounts on pages 22-25.

					
641068	641071	641069	642027	642075	642075
				642085	642085

The desk version of our popular Peak Design Booth – slightly slanted side screens are combined with a straight front screen in order to create a dynamic pattern by your work space. Choose between height 650 mm or 800 mm and four different widths to suit your spaces. Side screens width is as standard 800 mm. Play around with different coloured booths or use one tone to create a room divider in your environments.



Screen mounted on the desk with clamp or with pins above or through the desk. Can also stand on top of the desk. Can not be loaded with accessories.

## SCREENIT A30 ABOVE DESK

### ScreenIT A30 above desk

See price ranges in textile chapter.

			Pricer. 1	Pricer. 2	Pricer. 3	Pricer. 4
<b>With seam</b>						
857076-	W. 760	H. 450	121,70	143,19	217,13	258,94
857080-	W. 800	H. 450	121,70	143,19	217,13	258,94
857120-	W. 1200	H. 450	185,85	224,79	259,57	365,00
857140-	W. 1400	H. 450	196,38	237,23	269,04	414,89
857160-	W. 1600	H. 450	206,38	248,83	389,15	467,87
857180-	W. 1800	H. 450	244,47	293,30	434,89	521,06
857200-	W. 2000	H. 450	292,87	350,11	486,28	586,91
<b>With zip</b>						
857076-	W. 760	H. 450	165,00	187,02	259,04	302,23
857080-	W. 800	H. 450	165,00	187,02	259,04	302,23
857120-	W. 1200	H. 450	229,15	268,72	301,38	408,51
857140-	W. 1400	H. 450	239,79	281,17	310,96	458,30
857160-	W. 1600	H. 450	249,57	292,66	430,96	511,38
857180-	W. 1800	H. 450	287,98	337,13	476,49	564,57
857200-	W. 2000	H. 450	336,49	394,04	527,98	630,53

Order procedure desk screen, see page 27.

The brackets below fit the above items.

See all mounts on pages 22-25.





  
 642090 642088 642095 642089 642093



Desk screen for dividing workspace above desk. Height is adapted to be combined with a desk screen mounted with clamps. Total thickness 40 mm. Can not be loaded with accessories.

## SCREENIT A30 SIDESCREEN

### ScreenIT A30 Sidescreen







See price ranges in textile chapter.

			Pricer. 1	Pricer. 2	Pricer. 3	Pricer. 4
<b>With seam</b>						
760450-	W. 760	H. 450	172,98	181,49	254,89	370,74
800450-	W. 800	H. 450	172,98	181,49	254,89	370,74
<b>With zip</b>						
760450-	W. 760	H. 450	187,98	201,38	275,00	394,79
800450-	W. 800	H. 450	187,98	201,38	275,00	394,79

Order procedure desk screen, see page 27.

The brackets below fit the above items.

See all mounts on pages 22-25.





  
 642068 642082 642083 643011 643012 643013



ScreenIT Standard comes at a very affordable price. Combine textile, zip or seam as desired. The screen has a solid core covered by a foam laminated textile for sound absorption. Hole pattern from outer edge: 150 mm. It is also possible to use as pinboard or mount a toolbar for accessories. Maximum load 6 kg.

## SCREENIT STANDARD

ScreenIT Standard 650 mm

See price ranges in textile chapter.

With seam	Pricer. 1	Pricer. 2	Pricer. 3	Pricer. 4
640080- W. 800 H. 650	164,89	178,09	333,62	426,81
640120- W. 1200 H. 650	212,45	242,98	379,79	473,19
640140- W. 1400 H. 650	228,19	263,09	395,11	488,51
640160- W. 1600 H. 650	243,94	290,96	410,43	503,94
640180- W. 1800 H. 650	259,79	320,43	425,85	519,15
640200- W. 2000 H. 650	275,85	354,79	441,06	534,47

With zip	Pricer. 1	Pricer. 2	Pricer. 3	Pricer. 4
640080- W. 800 H. 650	212,45	225,43	379,79	473,19
640120- W. 1200 H. 650	259,89	290,11	425,96	519,26
640140- W. 1400 H. 650	275,96	310,43	441,28	534,57
640160- W. 1600 H. 650	291,49	338,19	456,60	549,89
640180- W. 1800 H. 650	307,55	367,77	471,81	565,21
640200- W. 2000 H. 650	322,98	402,13	487,23	580,43

ScreenIT Standard 800 mm

With seam	Pricer. 1	Pricer. 2	Pricer. 3	Pricer. 4
663080- W. 800 H. 800	209,47	212,02	437,34	616,49
663120- W. 1200 H. 800	257,02	273,40	499,04	678,51
663140- W. 1400 H. 800	273,09	296,17	601,17	780,21
663160- W. 1600 H. 800	288,62	347,02	674,26	853,51
663180- W. 1800 H. 800	304,47	370,00	747,45	926,70
663200- W. 2000 H. 800	320,43	392,55	777,98	1003,51

With zip	Pricer. 1	Pricer. 2	Pricer. 3	Pricer. 4
663080- W. 800 H. 800	257,02	259,36	483,19	662,66
663120- W. 1200 H. 800	304,57	320,53	545,21	724,36
663140- W. 1400 H. 800	320,53	343,30	647,23	826,60
663160- W. 1600 H. 800	336,28	394,26	720,21	899,68
663180- W. 1800 H. 800	351,91	417,23	793,51	972,98
663200- W. 2000 H. 800	367,87	440,21	824,15	11049,68

Facts: Desk thickness 20 mm applies to following measures.  
Screens H:650 mm: Clamp = H:450 mm above desk. Deskmount = H:430 mm above desk. Screens H:800 mm: Clamp = H:600 mm above desk. Deskmount = H:580 mm above desk.  
Max load 6 kg.

The brackets below fit the above items.

See all mounts on pages 22-25.

(A)	(B)	(E)	(F)	(G)	(X)	(EE)	(UU)
641010	641025	643047	643046	641020	642034	642075	643015
641056	641035			641057	642036	642085	643016
					642046		



## SCREENIT STANDARD

500 MM ABOVE DESK

ScreenIT Standard 650 mm

See price ranges in textile chapter.

With seam	Pricer. 1	Pricer. 2	Pricer. 3	Pricer. 4
6400805- W. 800 H. 650	164,89	178,09	333,62	426,81
6401205- W. 1200 H. 650	212,45	242,98	379,79	473,19
6401405- W. 1400 H. 650	228,19	263,09	395,11	488,51
6401605- W. 1600 H. 650	243,94	290,96	410,43	503,94
6401805- W. 1800 H. 650	259,79	320,43	425,85	519,15
6402005- W. 2000 H. 650	275,85	354,79	441,06	534,47

With zip	Pricer. 1	Pricer. 2	Pricer. 3	Pricer. 4
6400805- W. 800 H. 650	212,45	225,43	379,79	473,19
6401205- W. 1200 H. 650	259,89	290,11	425,96	519,26
6401405- W. 1400 H. 650	275,96	310,43	441,28	534,57
6401605- W. 1600 H. 650	291,49	338,19	456,60	549,89
6401805- W. 1800 H. 650	307,55	367,77	471,81	565,21
6402005- W. 2000 H. 650	322,98	402,13	487,23	580,43

Important info: Standard dimensions above desk with table top 20 mm: clamp clamp 520 mm, desk mount 500 mm. Maximum load 6 kg.

The brackets below fit the above items.

See all mounts on pages 22-25.

(A)	(B)	(E)	(F)	(G)	(X)	(EE)	(UU)
641010	641025	643047	643046	641020	642034	642075	643015
641056	641035			641057	642036	642085	643016
					642046		

Order procedure desk screen, see page 27.



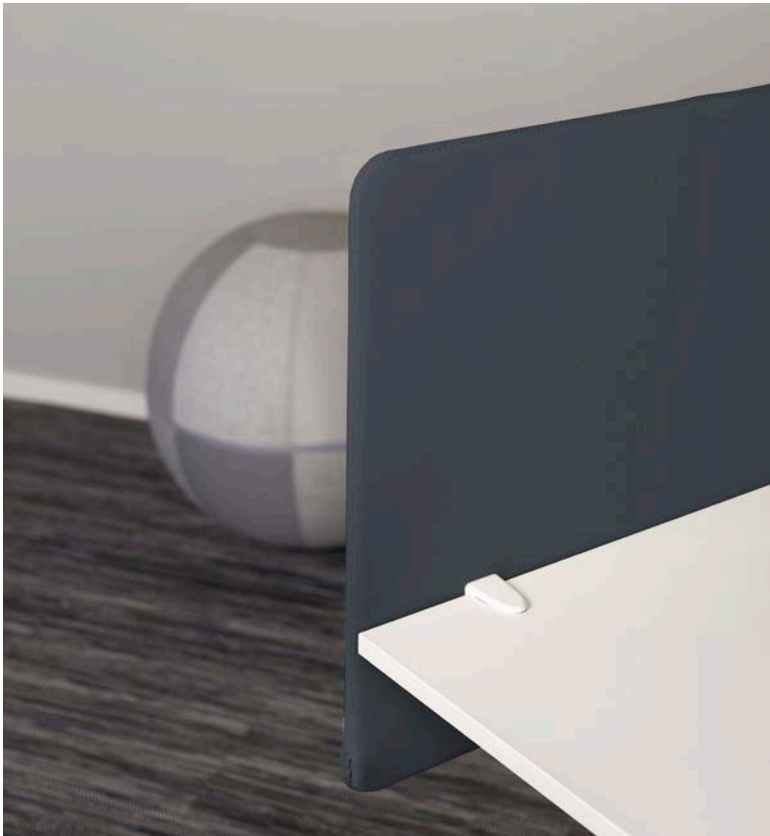

A thicker alternative to ScreenIT Standard that can take a load up to 25 kg. Built with a 16 mm thick MDF-board, dressed in laminated textile with a total thickness of 26 mm. Hole pattern from outer edge: 250 mm.

## SCREENIT STANDARD REINFORCED

### ScreenIT Standard Reinforced 650 mm

*See price ranges in textile chapter.*

With seam	Pricer. 1	Pricer. 2	Pricer. 3	Pricer. 4
500080- W. 800 H. 650	193,94	202,02	361,91	455,32
500120- W. 1200 H. 650	259,89	290,00	425,96	519,26
500140- W. 1400 H. 650	267,66	303,19	433,30	526,70
500160- W. 1600 H. 650	270,74	316,49	436,28	529,68
500180- W. 1800 H. 650	309,79	364,36	474,15	567,77
500200- W. 2000 H. 650	395,85	425,64	557,55	650,85

With zip	Pricer. 1	Pricer. 2	Pricer. 3	Pricer. 4
500080- W. 800 H. 650	240,11	248,09	406,49	499,89
500120- W. 1200 H. 650	305,96	336,17	470,64	563,83
500140- W. 1400 H. 650	313,72	349,36	477,87	571,38
500160- W. 1600 H. 650	316,81	362,45	480,85	574,26
500180- W. 1800 H. 650	355,96	410,43	518,94	612,55
500200- W. 2000 H. 650	441,60	471,81	587,77	695,53

### ScreenIT Standard Reinforced 800 mm

With seam	Pricer. 1	Pricer. 2	Pricer. 3	Pricer. 4
558080- W. 800 H. 800	268,51	280,00	478,94	685,11
558120- W. 1200 H. 800	334,47	345,64	572,02	721,60
558140- W. 1400 H. 800	342,13	381,60	675,43	823,72
558160- W. 1600 H. 800	345,21	416,60	739,89	896,70
558180- W. 1800 H. 800	384,36	455,96	823,09	969,89
558200- W. 2000 H. 800	470,21	493,83	881,70	1101,60

With zip	Pricer. 1	Pricer. 2	Pricer. 3	Pricer. 4
558080- W. 800 H. 800	314,57	325,96	523,62	729,57
558120- W. 1200 H. 800	380,32	391,70	616,60	766,38
558140- W. 1400 H. 800	388,09	427,55	720,00	868,40
558160- W. 1600 H. 800	391,17	462,66	784,57	941,49
558180- W. 1800 H. 800	430,43	502,02	867,77	1014,79
558200- W. 2000 H. 800	516,17	540,00	926,28	1146,28

Facts: Max load 25 kg. Total screen thickness 26 mm. Desk thickness 20 mm applies to following measures. Screens H:650 mm: Deskmount = H:430 mm above desk. Screens H:800 mm: Deskmount = H:580 mm above desk. Freewall not included, see Toolbar chapter.

The brackets below fit the above items.

See all mounts on pages 22-25.



641020	642034	642075
641057	642036	642085
	642046	

Order procedure desk screen, see page 27.



Silent Express is built with a wooden frame and a 30 mm sound absorbent. The screen is dressed in the unlaminated textile Cool, in one of our four colours below with a seam like the textile. Total thickness is 32 mm. Max load: 0 kg. Silent Express is a stocked screen.

## SILENT EXPRESS

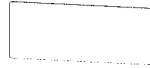

### Silent Express

510080-90	W. 800	H. 650	beige	141.28
510120-90	W. 1200	H. 650	beige	174.04
510140-90	W. 1400	H. 650	beige	195.43
510160-90	W. 1600	H. 650	beige	209.04
510180-90	W. 1800	H. 650	beige	222.34

### Silent Express

510080-91	W. 800	H. 650	light grey	141.28
510120-91	W. 1200	H. 650	light grey	174.04
510140-91	W. 1400	H. 650	light grey	195.43
510160-91	W. 1600	H. 650	light grey	209.04
510180-91	W. 1800	H. 650	light grey	222.34

### Silent Express

510080-92	W. 800	H. 650	dark grey	141.28
510120-92	W. 1200	H. 650	dark grey	174.04
510140-92	W. 1400	H. 650	dark grey	195.43
510160-92	W. 1600	H. 650	dark grey	209.04
510180-92	W. 1800	H. 650	dark grey	222.34

### Silent Express

510080-93	W. 800	H. 650	blue	141.28
510120-93	W. 1200	H. 650	blue	174.04
510140-93	W. 1400	H. 650	blue	195.43
510160-93	W. 1600	H. 650	blue	209.04
510180-93	W. 1800	H. 650	blue	222.34

Can only be chosen in the four colours from textile Cool below.

Can not be loaded with accessories. Total thickness 32 mm.

Desk thickness 20 mm applies to following measures.

Screens H:650 mm: Clamp = H. 450 mm above desk.

Desk mount = H. 430 mm above desk

The brackets below fit the above items.

See all mounts on pages 22-25.

(A)	(B)	(E)	(F)	(G)	(EE)	(JJ)
641010	641025	643047	643046	641020	642075 642085	643015 643016



Cool Beige



Cool Light grey

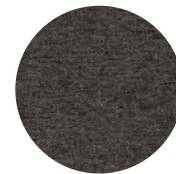

Cool Dark grey

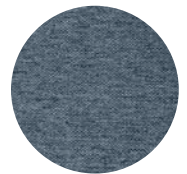

Cool Blue



Portable desk screen made of pressed felt with 100% recycled polyester fibres. Easy to fold and put away.

## FOLDIT BASIC FELT

### FoldIT Basic Felt

Made of pressed felt with 100% recycled polyester fibres.

621420	W. 500	H. 420	D. 400	dark grey	83.72
621420-1	W. 500	H. 420	D. 400	light grey	83.72
621820	W. 900	H. 420	D. 400	dark grey	90.74
621820-1	W. 900	H. 420	D. 400	light grey	90.74

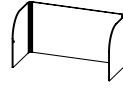
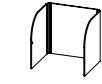

Note! Outer measures specified. Thickness 9 mm.

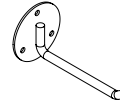

### Wall hook FoldIT Basic Felt

With space for 10 FoldIT Basic Felt. W. 60 H. 60 D. 117

671077-1	white	-2 black	-3 silver	32.34
----------	-------	----------	-----------	-------



Hook FoldIT Basic Felt





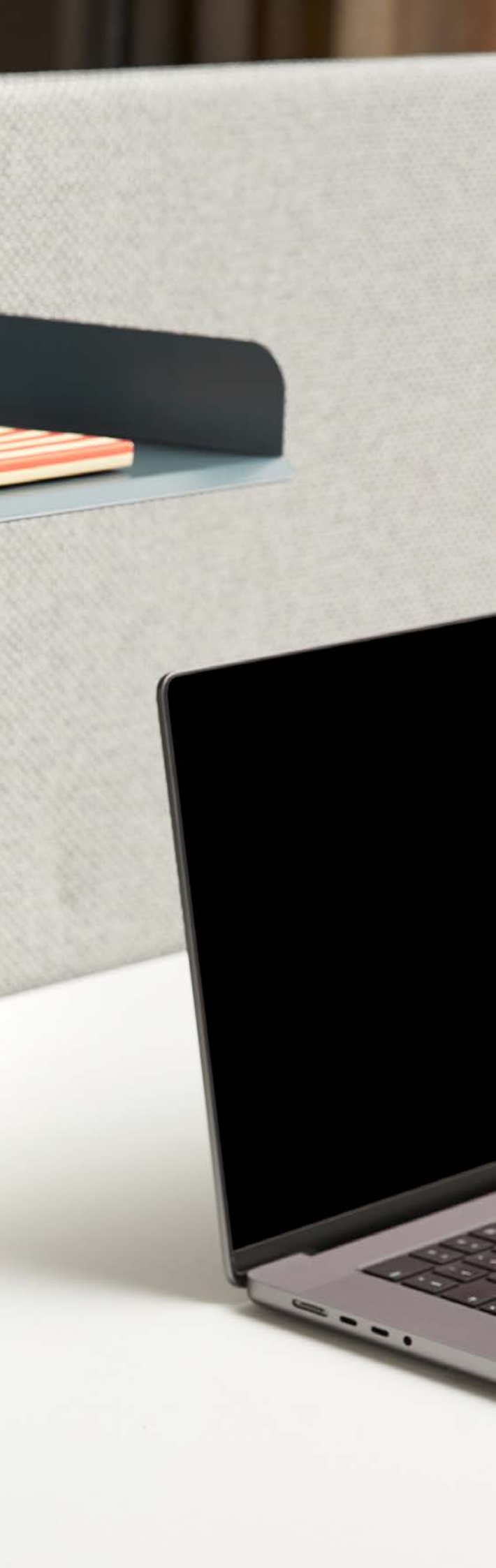

# ACCESSORIES, TOOLBAR RAILS

**T**oolbars enable you to create a practical and efficient workstation. All accessories are within easy reach placed on a suspended third level, keeping the desk surface clear and usable.

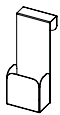

**Pen holder ScreenIT A30 +**

*Pen tray in metal to hang over the screen.*

W. 100 H. 250 D. 60

637200-1	white	50.96
637200-2	black	50.96
637200-21	green	50.96
637200-22	blue	50.96

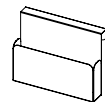

**A4 tray ScreenIT A30 +**

*A4 tray in metal to hang over the screen.*

W. 320 H. 250 D. 60

637201-1	white	67.34
637201-2	black	67.34
637201-21	green	67.34
637201-22	blue	67.34

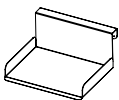
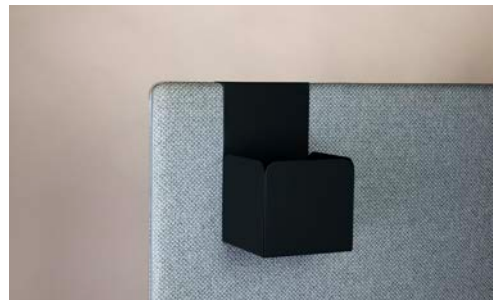

**A4 shelf ScreenIT A30 +**

*A4-shelf in metal to hang over the screen.*

W. 320 H. 158 D. 300

637202-1	white	65.21
637202-2	black	65.21
637202-21	green	65.21
637202-22	blue	65.21

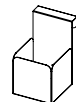

**Pot ScreenIT A30 +**

*Pot in metal to hang over the screen.*

W. 150 H. 250 D. 190

637203-1	white	68.51
637203-2	black	68.51
637203-21	green	68.51
637203-22	blue	68.51



**Pen holder +**  
 Material: lacquered metal  
 W. 80 H. 100 D. 80

637204-1	white	36.70
637204-2	black	36.70
637204-21	green	36.70
637204-22	blue	36.70



**Pot +**  
 Material: Lacquered metal. Plants with a maximum outer diameter of 137 mm fit this pot.  
 W. 140 H. 140 D. 140

637205-1	white	45.43
637205-2	black	45.43
637205-21	green	45.43
637205-22	blue	45.43

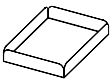

**Tray +**  
 Material: lacquered metal.  
 W. 230 H. 50 D. 320

637206-1	white	43.30
637206-2	black	43.30
637206-21	green	43.30
637206-22	blue	43.30

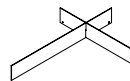

**Tray divider +.**  
 Material: lacquered metal. Suits in Tray +. See picture above.  
 W. 228 H. 40 D. 318

637207-1	white	32.34
637207-2	black	32.34
637207-21	green	32.34
637207-22	blue	32.34



## POCKET



### Pocket

Only fits ScreenIT A30 desk and floor screen. 2 smaller pockets, 1 larger pocket. Leather is always light beige; material: IMOLA. \*

W. 280 H. 350 D. 40

637126

brown leather

125.32



## LOOK



### Look

Only fits ScreenIT A30 screens. Lacquer and MDF are always white. Leather is always light beige, material: IMOLA. \*

W. 125 H. 290 D. 55

637127

white, brown leather

151.91

637132-1

white

118.51

\*Imola= 50% Polyester, 30% Cotton, 20% recycled leather.





## HOOK



### Hook

Only fits A30 screens. Lacquer is always white. Leather is always light beige, material: IMOLA.\*  
 W. 40 H. 100 D. 95

637129	white, brown leather	52.45
637134-1	white	20.53

\*Imola= 50% Polyester, 30% Cotton, 20% recycled leather.



## HOOK



### Hook for ScreenIT A30

Hook in metal to be hanged over the desk screen.  
 W. 60 H. 101 D. 48

671098	silver	20.21
671098-1	white	20.21
671098-2	black	20.21



## ACCESSORIES FOR SCREENS

Flexible plexitop for shielding between working stations. The smoked plexitop limits certain sundrop, easy to move around. Can be placed on any A30 screens to increase height.

### Plexitop 8 mm

451080	W. 800	H. 250	D. 8	transparent	107.66
451100	W. 1000	H. 250	D. 8	transparent	130.00
451120	W. 1200	H. 250	D. 8	transparent	143.09
451140	W. 1400	H. 250	D. 8	transparent	156.28
451160	W. 1600	H. 250	D. 8	transparent	169.15
451180	W. 1800	H. 250	D. 8	transparent	182.55
451200	W. 2000	H. 250	D. 8	transparent	195.64
452080	W. 800	H. 250	D. 8	frosted	123.40
452100	W. 1000	H. 250	D. 8	frosted	149.57
452120	W. 1200	H. 250	D. 8	frosted	169.15
452140	W. 1400	H. 250	D. 8	frosted	182.55
452160	W. 1600	H. 250	D. 8	frosted	195.64
452180	W. 1800	H. 250	D. 8	frosted	228.51
452200	W. 2000	H. 250	D. 8	frosted	248.09
453080	W. 800	H. 250	D. 8	smoked	156.28
453100	W. 1000	H. 250	D. 8	smoked	182.55
453120	W. 1200	H. 250	D. 8	smoked	208.83
453140	W. 1400	H. 250	D. 8	smoked	234.89
453160	W. 1600	H. 250	D. 8	smoked	261.28
453180	W. 1800	H. 250	D. 8	smoked	287.66
453200	W. 2000	H. 250	D. 8	smoked	313.83



### Clamp for Plexitop

Suitable for ScreenIT A30. 2 pcs in one pack.

642074-1 white -2 black

58.94/2pcs

### Clamp for Plexitop longer than 1600 mm

Suitable for ScreenIT A30. 3 pcs in one pack.

642076-1 white -2 black

99.57/3pcs

### Adjustable desk clamp for Plexitop, 18-26 mm

Fits ScreenIT AT40 and Standard Reinforced.

643041-1 white -2 black -3 silver

79.04/2pcs

643042-1 white -2 black -3 silver For top wider than 1600 mm 115.96/3pcs

### Adjustable desk clamp for Plexitop, 26-41 mm

Fits ScreenIT A30 and ScreenIT A40.

643043-1 white -2 black -3 silver

79.04/2pcs

643044-1 white -2 black -3 silver For top wider than 1600 mm 115.96/3pcs

Flexible plexitop for shielding between working stations. The smoked plexitop limits certain sundrop, easy to move around. Can be placed on any A30 screens to increase height.





## TOOLBAR LIGHT

Add a Toolbar Light to any our of rails - good lighting creates a better work environment. Hold down the on/off button to dim the light to the right strength for you and your work.



### Toolbar Light for rail

Cable length 1,90 m with USB contact at the end. Net adapter for wall socket included.

Watt: 4,5W.

Lumen max: 540 lm.

Colour temp: 4000K.

LUX max: 520lx at a height of 60 cm.

Beam angle: 95°.

821060-1

white

253.51

821060-3

silver

253.51



## A30 LIGHT

Lamp with screen mount for A30 screen. Add an A30 Light to your A30 screen - good lighting creates a better working environment. Hold down the on/off button to dim the light to the right brightness for you and your work tasks.

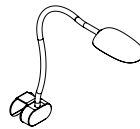

### A30 Light

Dimmable LED for mounting on A30 screen.

Watt: 4,5W.

Lumens max: 540Lm.

Colour temp: 4000K.

LUX max: 520lx at a height of 60 cm.

Lighting angle: 95 °.

637135-1

white

242.13

637135-3

silver

242.13



## TULIP



### Tulip Desk Lamp LED

Desk lamp with USB charger. Has an unearthed plug with 1,9 m cable.

821005

white/black

128.40



### Tray for Tulip for Freewall

W. 172 H. 190 D. 30

671087-1

white

48.09

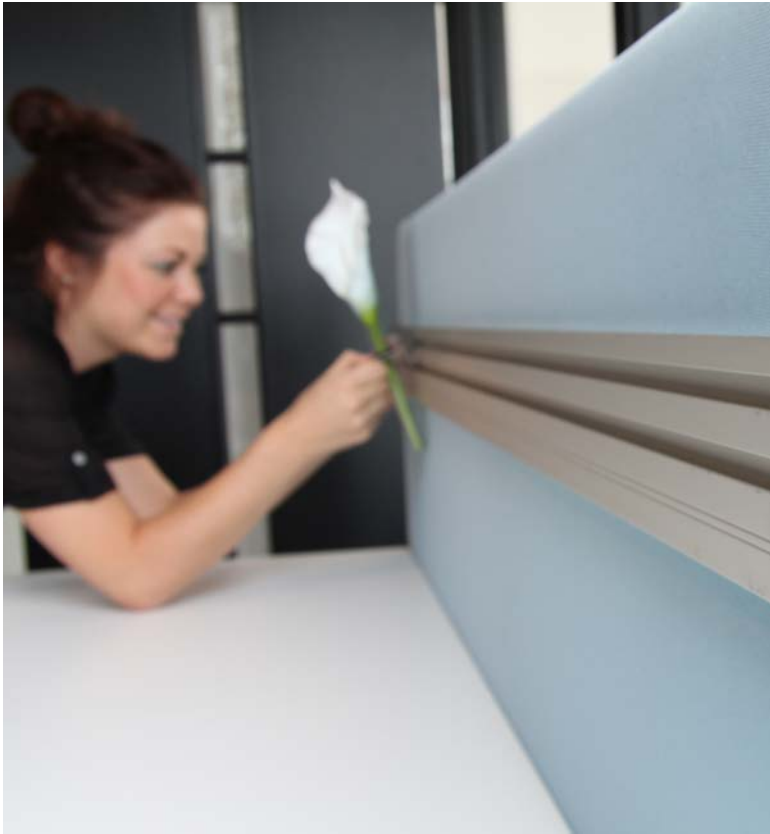

The toolbar that suits all accessories. It has a double profile concealing the attachment screws. Recommended mounting height: 310 mm above desk to top of the Freewall.

## FREEWALL



**Freewall double track**  
**Suitable for ScreenIT Standard, A30/A40 Reinforced and wallmount**  
*Extruded aluminium rail, 2 end covers and screws included.*

676075	L. 750	H. 80	D. 16	silver	58.72
676075-1	L. 750	H. 80	D. 16	white*	64.26
676115	L. 1150	H. 80	D. 16	silver	74.15
676115-1	L. 1150	H. 80	D. 16	white*	81.49
676135	L. 1350	H. 80	D. 16	silver	82.23
676135-1	L. 1350	H. 80	D. 16	white*	90.11
676155	L. 1550	H. 80	D. 16	silver	89.79
676155-1	L. 1550	H. 80	D. 16	white*	99.04
676175	L. 1750	H. 80	D. 16	silver	98.09
676175-1	L. 1750	H. 80	D. 16	white*	107.87
676195	L. 1950	H. 80	D. 16	silver	105.85
676195-1	L. 1950	H. 80	D. 16	white*	116.38



The toolbar can be screwed on a desk screen or to a wall. Recommended mounting height: 310 mm above desk to top of the Freewall. The Freewall toolbar can also be fixed directly on the wall or other solid vertical surfaces.



**Freewall**  
**Suitable for ScreenIT Standard and wallmount.**

*Extruded aluminium rail, 2 end covers and screws included. Max load 6 kg/ ScreenIT Standard, Max load 25 kg ScreenIT Standard reinforced. Max load for wall depends on the wall's material.*

670075	L. 750	H. 60	D. 14	silver	43.09
670075-1	L. 750	H. 60	D. 14	white*	47.77
670115	L. 1150	H. 60	D. 14	silver	60.43
670115-1	L. 1150	H. 60	D. 14	white*	66.28
670135	L. 1350	H. 60	D. 14	silver	67.98
670135-1	L. 1350	H. 60	D. 14	white*	74.57
670155	L. 1550	H. 60	D. 14	silver	76.06
670155-1	L. 1550	H. 60	D. 14	white*	83.72
670175	L. 1750	H. 60	D. 14	silver	83.62
670175-1	L. 1750	H. 60	D. 14	white*	92.02
670195	L. 1950	H. 60	D. 14	silver	94.89
670195-1	L. 1950	H. 60	D. 14	white*	104.26



**Freewall**  
**Suitable for ScreenIT A30/A40 Reinforced desk screen**

*Extruded aluminium rail, 2 end covers and screws included. Height 60 mm, width 14 mm. Max load 25 kg.*

671075	L. 750	H. 60	D. 14	silver	43.09
671075-1	L. 750	H. 60	D. 14	white*	47.77
671115	L. 1150	H. 60	D. 14	silver	60.43
671115-1	L. 1150	H. 60	D. 14	white*	66.28
671135	L. 1350	H. 60	D. 14	silver	67.98
671135-1	L. 1350	H. 60	D. 14	white*	74.57
671155	L. 1550	H. 60	D. 14	silver	76.06
671155-1	L. 1550	H. 60	D. 14	white*	83.72
671175	L. 1750	H. 60	D. 14	silver	83.62
671175-1	L. 1750	H. 60	D. 14	white*	92.02
671195	L. 1950	H. 60	D. 14	silver	94.89
671195-1	L. 1950	H. 60	D. 14	white*	104.26

Delivery time 5-10 days.



Posts and arms are made of extruded aluminium. The attachments are casted in aluminium or laser cut sheet. Rail length, see [www.gotessons.com](http://www.gotessons.com).

## LINJÉ 4WAY TOOLBAR

Creating a stable third level allows for more workspace and is ideal when working with multiple monitors. Max load 100 kg. Select required accessories shown on page 41-45.



### Linjé 4way Toolbar

Toolbar rail with 2x400 mm posts, 2 desk clamps.  
For desk max 45 mm.

692140	1400 mm Clamp set	silver	380.85
692140-1	1400 mm Clamp set	white*	418.83
692160	1600 mm Clamp set	silver	397.34
692160-1	1600 mm Clamp set	white*	437.02
692180	1800 mm Clamp set	silver	414.04
692180-1	1800 mm Clamp set	white*	455.43

### Linjé 4Way Toolbar

As shown on all pictures the Clamp small are more discreet.  
For up to 42 mm desks.

694140	1400 mm clamp small	silver	380.85
694140-1	1400 mm clamp small	white*	418.83
694160	1600 mm clamp small	silver	397.34
694160-1	1600 mm clamp small	white*	437.02
694180	1800 mm clamp small	silver	414.04
694180-1	1800 mm clamp small	white*	455.43

### Linjé 4Way Toolbar

Toolbar rail with 2x400 mm posts, 2 desk mounts.

693140	1400 mm Desk mount set	silver	380.85
693140-1	1400 mm Desk mount set	white*	418.83
693160	1600 mm Desk mount set	silver	397.34
693160-1	1600 mm Desk mount set	white*	437.02
693180	1800 mm Desk mount set	silver	414.04
693180-1	1800 mm Desk mount set	white*	455.43

Delivery time 5-10 days.



## TOOLBAR ARMS



### ZAP Toolbar 3

Incl. toolmount. Weight span 1,5-7 kg.  
L. 505 H. 399

616525	silver	246.28
616525-1	white	246.28
616525-2	black	246.28



### D-Zine Toolbar 1

Max weight 12 kg.  
L. 130 H. 135

611525	silver	107.02
611525-1	white	107.02
611525-2	black	107.02



### D-Zine Toolbar 2

Max weight 12 kg.  
L. 315 H. 135

611526	silver	153.51
611526-1	white	153.51
611526-2	black	153.51



### D-Zine Toolbar 3

Gas arm. Incl. toolmount. Weight span 1,5-8,5 kg.  
L. 470 H. 360

611325	silver	193.94
611325-1	white	193.94
611325-2	black	193.94

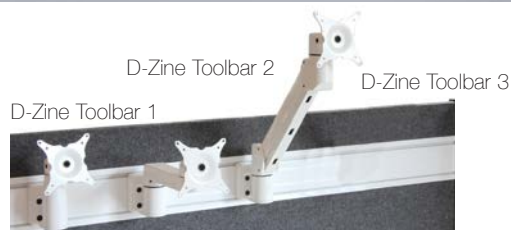

# COMPARE SCREENS



## SCREENIT FLEXIBLE

As ScreenIT A30 without holes. Can be used as a desk or floor screen or wall mounted.



## SCREENIT A30 FLOOR SCREEN

Wooden frame filled with sound absorbing anti-allergy foam and lined with foam laminated textile. Total thickness 40 mm.



## SCREENIT A30/A40 FLOOR SCREEN WITH STRAIGHT CORNER

Wooden frame filled with sound absorbing anti-allergy foam and lined with foam laminated textile. Straight corner. Thickness A40 50 mm.



## THE RISING

A patented floor screen that you can raise and lower freely to the desired height. The screen is a ScreenIT A30.



## SCREENIT A30 FLOOR SCREEN BOOTH BUILDABLE

The floor screens are zipped together to form a booth on adjustable feet. Material like ScreenIT A30.



## A30 PEAK DESIGN BOOTH

Sound absorbing booth solution with a slight tilted side screen to create dynamics and openness. The booth is coupled with zipper and can therefore be built in infinity. Total thickness 40 mm.

*Read more and compare our desk screens and desk screen booths in the Desk Screen Chapter.*

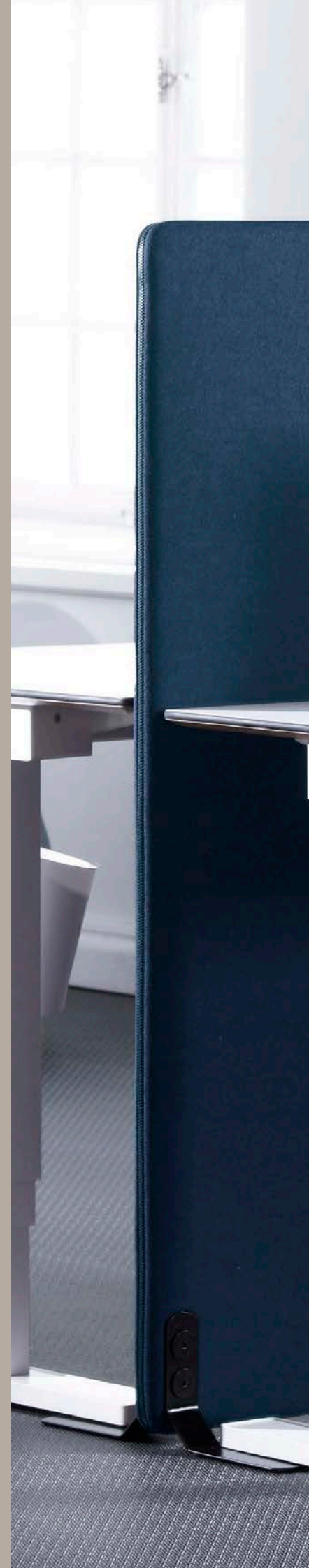

# FLOOR SCREENS AND FLOOR SCREEN BOOTHS

In today's open office landscapes, floor screens can make the difference needed for the working climate. Screens that create rooms within the room, screens that take care of noise and buzz from office machines, writing on keyboards and talking colleagues. Everything from flexible screens to room dividers and booths can be found on these pages.

## ORDER PROCEDURE

### FLOOR SCREEN

1. SELECT SCREEN AND SCREEN SIZE
2. SELECT TEXTILE COLOUR  
See colour map at page 6-16.
3. SELECT ZIP OR SEAM COLOUR  
See colours on page 17.
4. SELECT CLAMPS OR MOUNTS  
See page 22-25.

Specify the article number as follows: Desk screen size - textile colour - zip/seam colour.  
Example: 644140 - 01 - 101  
Colour code within the parenthesis is the textile producer's own colour code, is not used for orders.

### FLOOR SCREEN BOOTHS

1. SELECT SCREEN AND SCREEN SIZE
2. SELECT TEXTILE COLOUR  
See colour map at page 6-16.
3. SELECT SEAM COLOUR  
See colours on page 17.
4. SELECT ZIP TO CONNECT SCREENS  
See page 17.
5. SELECT CLAMPS OR MOUNTS  
See page 22-25.

Specify the article number as follows: Screen booth - textile colour - seam colour - zip colour.  
Example: 1178160 - 14 - 206 - 101  
Colour code within the parenthesis is the textile producer's own colour code, is not used for orders.

Below screens and textiles are Nordic Eco labeled in combination with each other.

**SCREENS**  
ScreenIT A30 Floor Screen

**TEXTILES**  
Bond  
Cara  
Mica  
Rivet



Applies in combination with foot pack in white and black.

For updated information, see  
[www.gotessons.com](http://www.gotessons.com)



A30 Floor screen provides a stable, stylish and practical shielding in open plan areas.  
Total thickness 40 mm.



\* For screens with a width over 1200 mm, we might add a decor seam when the textile width is not sufficient. Contact Gotessons if you have any questions.

## SCREENIT A30 FLOOR SCREEN

### ScreenIT A30 floor screen

See price ranges in textile chapter.

With seam			Pricer. 1	Pricer. 2	Pricer. 3	Pricer. 4
632120-	W. 800	H. 1200	274,79	337,13	507,87	702,66
632140-	W. 800	H. 1400	303,94	372,13	603,30	802,13
632160-	W. 800	H. 1600	332,66	406,28	672,02	873,30
632180-	W. 800	H. 1800	361,91	444,26	740,32	944,68
634120-	W. 1000	H. 1200	347,23	412,02	577,55	775,21
634140-	W. 1000	H. 1400	376,17	431,70	618,94	818,19
634160-	W. 1000	H. 1600	390,74	448,19	700,64	903,30
634180-	W. 1000	H. 1800	488,83	563,30	754,79	946,28
636120-	W. 1200	H. 1200	354,68	471,81	584,47	782,55
636140-	W. 1200	H. 1400	383,51	488,62	639,36	839,68
636160-	W. 1200	H. 1600	412,45	506,28	721,49	946,81
636180-	W. 1200	H. 1800	510,11	595,21	797,34	988,83
669120-	W. 1400	H. 1200	383,51	488,62	639,36	839,68
669140-*	W. 1400	H. 1400	435,74	535,11	877,87	1098,19
669160-*	W. 1400	H. 1600	477,87	570,00	962,34	1192,45
669180-*	W. 1400	H. 1800	542,77	667,23	1043,94	1286,38
653120-	W. 1600	H. 1200	434,36	512,55	742,55	946,81
653140-*	W. 1600	H. 1400	477,87	570,00	962,34	1192,45
653160-*	W. 1600	H. 1600	521,28	627,98	1037,23	1288,40
With zip			Pricer. 1	Pricer. 2	Pricer. 3	Pricer. 4
632120-	W. 800	H. 1200	318,40	381,28	549,79	746,28
632140-	W. 800	H. 1400	347,23	415,96	645,32	845,64
632160-	W. 800	H. 1600	376,17	450,43	713,62	917,02
632180-	W. 800	H. 1800	405,32	488,30	782,23	988,19
634120-	W. 1000	H. 1200	390,32	455,96	619,47	818,62
634140-	W. 1000	H. 1400	419,79	475,85	660,85	861,91
634160-	W. 1000	H. 1600	434,36	492,13	742,55	946,81
634180-	W. 1000	H. 1800	531,38	616,49	818,62	988,83
636120-	W. 1200	H. 1200	397,87	515,96	626,17	826,06
636140-	W. 1200	H. 1400	427,02	532,66	681,28	882,98
636160-	W. 1200	H. 1600	455,96	550,21	763,30	990,11
636180-	W. 1200	H. 1800	563,30	648,40	850,53	1010,11
669120-	W. 1400	H. 1200	427,02	532,66	681,28	882,98
669140-*	W. 1400	H. 1400	479,04	579,04	935,85	1157,98
669160-*	W. 1400	H. 1600	521,28	613,83	1020,11	1251,81
669180-*	W. 1400	H. 1800	586,28	710,96	1101,38	1345,11
653120-	W. 1600	H. 1200	477,87	556,38	784,36	990,11
653140-*	W. 1600	H. 1400	521,28	613,83	1020,11	1251,81
653160-*	W. 1600	H. 1600	564,79	671,70	1099,57	1352,13

### Order procedure floor screen, see page 55.

For floor screen accessories, please see Toolbar chapter.

\*Screens over 1200 mm ordered with textiles: Ally, Blazer, Bond, Era, Houston Reflect, Illusion II, Kaiman, Lido, Noble lux, Remix 3, Rivet and Synergy will be with a decor seam.

Brackets for the above items. See all mounts on pages 22-25.



641040

643070



641055



641066



# SCREENIT A30 COLLECT

## ScreenIT A30 Collect Floor screen

See price ranges in textile chapter.

With seam			Pricer. 1	Pricer. 2	Pricer. 3	Pricer. 4
685120-	W. 800	H. 1200	274,79	337,13	507,87	702,66
685140-	W. 800	H. 1400	303,94	372,13	603,30	802,13
685160-	W. 800	H. 1600	332,66	406,28	672,02	873,30
685180-	W. 800	H. 1800	361,91	444,26	740,32	944,68
686120-	W. 1000	H. 1200	347,23	412,02	577,55	775,21
686140-	W. 1000	H. 1400	376,17	431,70	618,94	818,19
686160-	W. 1000	H. 1600	390,74	448,19	700,64	903,30
686180-	W. 1000	H. 1800	488,83	563,30	754,79	946,28
689120-	W. 1200	H. 1200	354,68	471,81	584,47	782,55
689140-	W. 1200	H. 1400	383,51	488,62	639,36	839,68
689160-	W. 1200	H. 1600	412,45	506,28	721,49	946,81
689180-	W. 1200	H. 1800	510,11	595,21	797,34	988,83
690120-	W. 1400	H. 1200	383,51	488,62	639,36	839,68
690140-*	W. 1400	H. 1400	435,74	535,11	877,87	1098,19
690160-*	W. 1400	H. 1600	477,87	570,00	962,34	1192,45
690180-*	W. 1400	H. 1800	542,77	667,23	1043,94	1286,38
691120-	W. 1600	H. 1200	434,36	512,55	742,55	946,81
691140-*	W. 1600	H. 1400	477,87	570,00	962,34	1192,45
691160-*	W. 1600	H. 1600	521,28	627,98	1037,23	1288,40
With zip						
685120-	W. 800	H. 1200	318,40	381,28	549,79	746,28
685140-	W. 800	H. 1400	347,23	415,96	645,32	845,64
685160-	W. 800	H. 1600	376,17	450,43	713,62	917,02
685180-	W. 800	H. 1800	405,32	488,30	782,23	988,19
686120-	W. 1000	H. 1200	390,32	455,96	619,47	818,62
686140-	W. 1000	H. 1400	419,79	475,85	660,85	861,91
686160-	W. 1000	H. 1600	434,36	492,13	742,55	946,81
686180-	W. 1000	H. 1800	531,38	616,49	818,62	988,83
689120-	W. 1200	H. 1200	397,87	515,96	626,17	826,06
689140-	W. 1200	H. 1400	427,02	532,66	681,28	882,98
689160-	W. 1200	H. 1600	455,96	550,21	763,30	990,11
689180-	W. 1200	H. 1800	563,30	648,40	850,53	1010,11
690120-	W. 1400	H. 1200	427,02	532,66	681,28	882,98
690140-*	W. 1400	H. 1400	479,04	579,04	935,85	1157,98
690160-*	W. 1400	H. 1600	521,28	613,83	1020,11	1251,81
690180-*	W. 1400	H. 1800	586,28	710,96	1101,38	1345,11
691120-	W. 1600	H. 1200	477,87	556,38	784,36	990,11
691140-*	W. 1600	H. 1400	521,28	613,83	1020,11	1251,81
691160-*	W. 1600	H. 1600	564,79	671,70	1099,57	1352,13

This screen is built like an A30, but has a different hole pattern for feet with wheels. This means that the screens can be placed next to each other to save space when they are not in use.

### Order procedure floor screen, see page 55.

For floor screen accessories, please see Toolbar chapter.

\*Screens over 1200 mm ordered with textiles: Ally, Blazer, Bond, Era, Houston Reflect, Illusion II, Kaiman, Lido, Noble lux, Remix 3, Rivet and Synergy will be with a decor seam.

Brackets for the above items. See all mounts on pages 22-25.



641066 643067



A30/A40 straight corner is a stylish rectangular floor screen, a good sound absorber/room divider with a total thickness of A30=40 mm, A40=50 mm. Also available as desk screen.



QQ

**Foot set Woodland for Floorscreen A30**  
Foot in molded wood with whitewashed ash veneer and metal fittings that fit A30 floor screen. 4 feet included.

643068-1	white*/whitewashed ash	257.98
643068-2	black*/whitewashed ash	257.98
643068-3	silver*/whitewashed ash	257.98

RR

**Foot set Woodland for A40/Sketch Floorscreen**

Foot in molded wood with whitewashed ash veneer and metal fittings that fit Sketch / A40 floor screen. 4 feet included.

643066-1	white*/whitewashed ash	257.98
643066-2	black*/whitewashed ash	257.98
643066-3	silver*/whitewashed ash	257.98

\*Colour indicates fittings.

SS

**Foot set Woodland with wheels for Floorscreen A30**

Foot set in molded wood with whitewashed ash veneer and metal fittings that fits A30 floor screen. 4 feet with wheels included.  
The wheels are lockable.

643067-1	white*/whitewashed ash	335.43
643067-2	black*/whitewashed ash	335.43
643067-3	silver*/whitewashed ash	335.43

TT

**Foot Set Slide-in Woodland with wheels for A40/Sketch Floor screen**

Foot set in molded wood with whitewashed ash veneer and metal fittings that fits Sketch/A40 floor screen. 4 feet with wheels included.  
The wheels are lockable.

643065-1	white*/whitewashed ash	335.43
643065-2	black*/whitewashed ash	335.43
643065-3	silver*/whitewashed ash	335.43

\*Colour indicates wheels and fittings.

## SCREENIT A30 SCREEN STRAIGHT CORNERS

ScreenIT A30 straight corner floor screen

See price ranges in textile chapter.

A30 with seam	Pricer. 1	Pricer. 2	Pricer. 3	Pricer. 4
532120- W. 800 H. 1200	274,79	337,13	507,87	702,66
532140- W. 800 H. 1400	303,94	372,13	603,30	802,13
532160- W. 800 H. 1600	332,66	406,28	672,02	873,30
532180- W. 800 H. 1800	361,91	444,26	740,32	944,68
534120- W. 1000 H. 1200	347,23	412,02	577,55	775,21
534140- W. 1000 H. 1400	376,17	431,70	618,94	818,19
534160- W. 1000 H. 1600	390,74	448,19	700,64	903,30
536120- W. 1200 H. 1200	354,68	471,81	584,47	782,55
536140- W. 1200 H. 1400	383,51	488,62	639,36	839,68
536160- W. 1200 H. 1600	412,45	506,28	721,49	946,81
569120- W. 1400 H. 1200	383,51	488,62	639,36	839,68
569140-*W. 1400 H. 1400	435,74	535,11	877,87	1098,19
569160-*W. 1400 H. 1600	477,87	570,00	962,34	1192,45
569180-*W. 1400 H. 1800	542,77	667,23	1043,94	1286,38
553120- W. 1600 H. 1200	434,36	512,55	742,55	946,81
553140-*W. 1600 H. 1400	477,87	570,00	962,34	1192,45
553160-*W. 1600 H. 1600	521,28	627,98	1037,23	1288,40

Order procedure floor screen, see page 55.

The brackets below fit the above items.

See all mounts on pages 22-25.



641040 641055 641066  
643070

## SCREENIT A40 FLOOR SCREEN STRAIGHT CORNER

ScreenIT A40 floorscreen straight corner

See price ranges in textile chapter.

A40 with seam	Pricer. 1	Pricer. 2	Pricer. 3	Pricer. 4
537120- W. 800 H. 1200	291,60	357,66	523,19	724,15
537140- W. 800 H. 1400	322,34	394,68	621,49	826,28
537160- W. 800 H. 1600	353,19	430,96	692,13	899,57
537180- W. 800 H. 1800	383,62	471,49	762,55	973,09
533120- W. 1000 H. 1200	368,51	437,23	594,89	798,51
533140- W. 1000 H. 1400	399,26	458,09	637,55	842,87
533160- W. 1000 H. 1600	414,36	475,64	721,60	930,21
555120- W. 1200 H. 1200	376,06	500,74	601,91	805,85
555140- W. 1200 H. 1400	406,81	518,51	658,72	864,89
555160- W. 1200 H. 1600	437,66	536,91	743,19	975,32
554120- W. 1400 H. 1200	406,81	518,51	658,72	864,89
554140-*W. 1400 H. 1400	462,34	567,87	904,15	1131,17
554160-*W. 1400 H. 1600	506,91	604,57	991,17	1228,40
554180-*W. 1400 H. 1800	575,96	707,87	1075,11	1324,89
557120- W. 1600 H. 1200	460,85	543,62	764,68	975,32
557140-*W. 1600 H. 1400	506,91	604,57	991,17	1228,40
557160-*W. 1600 H. 1600	552,98	665,96	1068,51	1327,02

Order procedure floor screen, see page 55.

Foot set for A40 Floor screen

4 in one pack. About 25 mm between the floor and the bottom of the floor screen.

642015-1	white -2 black -3 silver	76.81
----------	--------------------------	-------

Foot set Big for A40 Floor screen

4 in one pack. About 60 mm between the floor and the bottom of the floor screen.

643075-1	white -2 black -3 silver	76.81
----------	--------------------------	-------

Corner foot set support for angled screens, A40

4 in one pack. 3 standard and 1 angle.

642035-1	white -2 black -3 silver	76.81
----------	--------------------------	-------

Foot set with wheels for A40 Floor screen

Lockable wheels. 4 in one pack. About 45 mm between the floor and the bottom of the floor screen.

641067-1	white -2 black -3 silver	136.06
----------	--------------------------	--------

\*Screens over 1200 mm ordered with textiles: Ally, Blazer, Bond, Era, Houston Reflect, Illusion II, Kaiman, Lido, Noble lux, Remix 3, Rivet and Synergy will be with a decor seam.

Link fittings ScreenIT A30 Floor screen two-ways

641051-1	white -2 black -3 silver	22.02/pc
----------	--------------------------	----------

Link fittings ScreenIT A30 Floor screen two-ways angle

641052-1	white -2 black -3 silver	29.57/pc
----------	--------------------------	----------

Link fittings ScreenIT A30 Floor screen three ways angle

641053-1	white -2 black -3 silver	32.77/pc
----------	--------------------------	----------

Link fittings ScreenIT A30 Floor screen four ways angle

641054-1	white -2 black -3 silver	41.70/pc
----------	--------------------------	----------

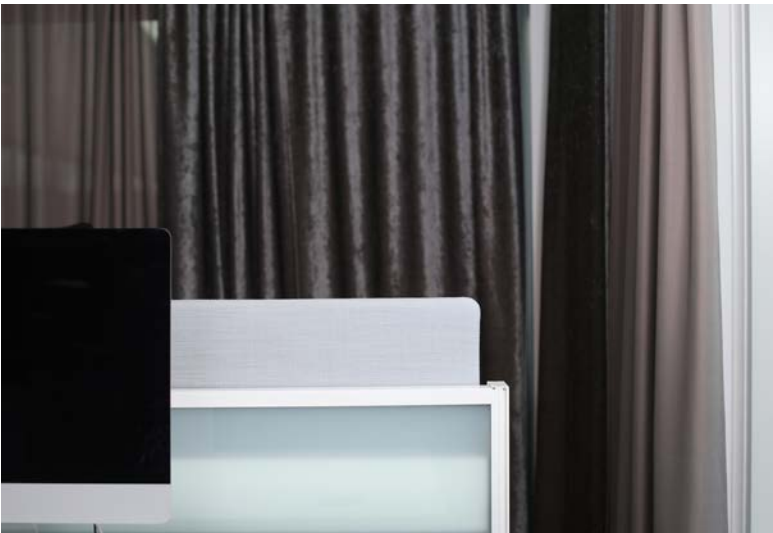

**PATENTED** THE RISING



## SCREENIT A30 THE RISING

A floor screen that you can raise and lower freely to the desired height, 1100-1800 mm. Ideal in a classic desktop environment when you easily and quickly want to work undisturbed and in an open landscape to change the layout of the room. The Rising is Patented. See film on [gotessons.com](http://gotessons.com).

### ScreenIT A30 The Rising

*See price ranges in textile chapter.*

		Pricer. 1	Pricer. 2	Pricer. 3	Pricer. 4
<b>With seam</b>					
641400-	W. 1300 H. 1010	355,96	424,89	548,62	748,09
641600-	W. 1500 H. 1010	410,21	444,15	719,36	1002,02
641800-	W. 1700 H. 1010	481,49	590,43	793,62	1108,40
<b>With zip</b>					
641400-	W. 1300 H. 1010	379,79	442,45	573,51	775,43
641600-	W. 1500 H. 1010	431,81	471,17	746,28	1032,02
641800-	W. 1700 H. 1010	510,53	619,89	823,09	1140,85

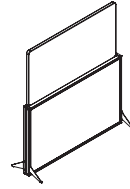

#### Stand for The Rising, frosted

*Width: 1400 mm. Suitable for screen 1300 mm.*

661400-1 white -2 black 2216.91

#### Stand for The Rising, frosted

*Width: 1600 mm. Suitable for screen 1500 mm.*

661600-1 white -2 black 2392.13

#### Stand for The Rising, frosted

*Width: 1800 mm. Suitable for screen 1700 mm.*

661800-1 white -2 black 2537.87

#### Stand for The Rising, smoked

*Width: 1400 mm. Suitable for screen 1300 mm.*

671400-1 white -2 black 2216.91

#### Stand for The Rising, smoked

*Width: 1600 mm. Suitable for screen 1500 mm.*

671600-1 white -2 black 2392.13

#### Stand for The Rising, smoked

*Width: 1800 mm. Suitable for screen 1700 mm.*

671800-1 white -2 black 2537.87

#### Foot set for The Rising

*4 pcs in a pack, 2 pcs left and 2 pcs right. 0-40 mm between floor and bottom edge of floor screen.*

648000-1 white -2 black 295.96



#### SUPPLEMENTS FOR THE RISING

##### Corner profile for The Rising

*To connecting stands together in an angle.*

648020-1 white -2 black 306.28



##### Foot set for The Rising

*To connecting stands together with a corner profile. 2 in a pack: 1 pc left and 1 pc right.*

648010-1 white -2 black 148.19



#### Order procedure for The Rising

**1: Choose size and colour for the screen.**

**Specify the article number for the screen as follow:**

**Ex. 641600-01-101** Size on screen - colour of textile - colour of zip or seam.

**2: Choose colour and glass for the stand.**

**3: Choose colour for Foot Set.**

**4: Add a corner profile if placed in an angle or in a row.**

**Facts: Measurement: adjustable height 1100-1800 mm.**

**Total thickness of absorbent 40 mm. When placing screens in an angle, use the corner profile for connecting stands and complete with 2 pack foot set.**



## SCREENIT A30 BOOTH

### ScreenIT A30 Booth Buildable

*See price ranges in textile chapter.*

Booth two desks black feet	Pricer. 1	Pricer. 2	Pricer. 3	Pricer. 4
1161140-* W. 1400 H. 1400	2062,87	2313,72	2823,51	3775,96
1161160-* W. 1600 H. 1400	2126,38	2381,91	2912,55	3902,45
1161180-* W. 1800 H. 1400	2187,23	2449,68	3000,96	4028,09

Booth four desks black feet	Pricer. 1	Pricer. 2	Pricer. 3	Pricer. 4
1162140-* W. 1400 H. 1400	3364,89	3761,60	4595,21	6144,68
1162160-* W. 1600 H. 1400	3486,81	3899,15	4745,21	6390,21
1162180-* W. 1800 H. 1400	3603,62	4034,89	4932,13	6667,98

**Order procedure floor screen, see page 55.**

Important information: Inner dimensions. Mounted feet included.  
 Can only be ordered with seam. Zipper is only used to connect screens.  
 Not available with fishbone zip. Grommet in black.  
 Silver and white as special.

With a double zip on both sides the booth can be increased in length as depicted.

Pricelist height is 1400 mm and side screens' width is 900 mm.  
 For other sizes, please contact Gotessons.

For floor screen accessories, please see Toolbar chapter.

\*Screens over 1200 mm ordered with textiles: Ally, Blazer, Bond, Era, Houston Reflect, Illusion II, Kaiman, Lido, Noble lux, Remix 3, Rivet and Synergy will be with a decor seam.



The floor screens are zipped together to form a booth on adjustable feet. Pricelist height is 1400 mm and the side screen's width is 800 mm. Feet are included. The booth screens are with a seam. The zipper is to connect the screens together. Not available with fishbone zip. For other sizes, request a quote.



Peak Design Booth is a booth solution with a slight tilted side screen to create dynamics and openness. The booth is coupled with zipper and can therefore be built in infinity. The height is as standard 1400 mm and the side screens have two different depths either 850 mm or 1200 mm. Select screens in the same textile or in a color scale to create unique workplaces. Keep clean and tidy around and under the desk by choosing a recessed cable grommet in the screens.

## SCREENIT A30 BOOTH

### ScreenIT A30 floor screen booth

See price ranges in textile chapter.

Booth with black feet	Pricer. 1	Pricer. 2	Pricer. 3	Pricer. 4
852120- W. 1200 H. 1400	1229,57	1323,30	2040,00	2624,57
852140-*W. 1400 H. 1400	1279,89	1373,83	2343,19	2767,55
852160-*W. 1600 H. 1400	1320,11	1428,72	2386,81	2897,02
852180-*W. 1800 H. 1400	1382,66	1451,60	2452,23	3022,02

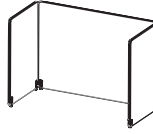

Order procedure floor screen, see page 55.

For floor screen accessories, please see Toolbar chapter.



### ADJUSTABLE FEET

Floor screen booths include adjustable feet. Adjustable up to 50 mm.

## A30 PEAK DESIGN BOOTH

### A30 Peak Design Booth

See price ranges in textile chapter.

Front screen without grommet	Pricer. 1	Pricer. 2	Pricer. 3	Pricer. 4
119120-*W. 1200 H. 1400	555,64	577,98	718,40	941,17
119140-*W. 1400 H. 1400	580,74	616,06	970,11	1246,60
119160-*W. 1600 H. 1400	630,43	649,89	1087,87	1401,81
119180-*W. 1800 H. 1400	699,89	742,98	1197,23	1547,77

### Front screen with grommet Ø 60

119121-*W. 1200 H. 1400	665,53	688,40	820,74	1047,98
119141-*W. 1400 H. 1400	686,91	724,89	1069,47	1350,32
119161-*W. 1600 H. 1400	736,91	760,96	1187,13	1505,00
119181-*W. 1800 H. 1400	806,49	851,81	1296,91	1651,28

### Side screen big without grommet

119124- W. 1200 H. 1400	635,11	696,17	850,85	1044,57
-------------------------	--------	--------	--------	---------

### Side screen big with grommet Ø 60

119125- W. 1200 H. 1400	726,17	789,68	935,96	1132,87
-------------------------	--------	--------	--------	---------

### Side screen small without grommet

119854- W. 850 H. 1400	515,96	534,26	764,79	954,89
------------------------	--------	--------	--------	--------

### Side screen small with grommet Ø 60

119855- W. 850 H. 1400	607,13	627,98	849,79	1043,51
------------------------	--------	--------	--------	---------

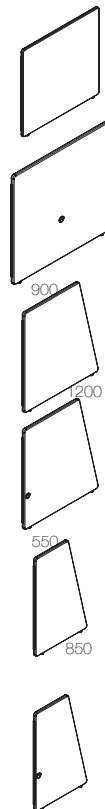

Important information: Inner dimensions. Mounted feet included. Can only be ordered with seam. Zipper is only used to connect screens. Not available with fishbone zip. Grommet in black. Silver and white as special.

For floor screen accessories, please see Toolbar chapter.

\*Screens over 1200 mm ordered with textiles: Ally, Blazer, Bond, Era, Houston Reflect, Illusion II, Kaiman, Lido, Noble lux, Remix 3, Rivet and Synergy will be with a decor seam.





# ROOM WITHIN A ROOM

Creating natural meeting places in large open spaces that today's offices often are made of, is one of the strengths with the room-within-a-room concept. Our products contributes with a dynamic feeling and an eye-catching detail, all while the screened off spaces generate creative condition and improve acoustics for everyone.

# CASA

FROM: GÖTESSONS



DESIGN 04 | DESIGN STUDIO



# WELCOME TO AN EVEN QUIETER ROOM WITHIN A ROOM

Casa uno is the phone booth designed for those who need extra concentration or need to make important phone calls that shouldn't be overheard. Inside, you'll find a fixed table for your computer, power outlets, charging ports, comfortable dimmable lighting, and an optional barstool. The booth is also equipped with automatic ventilation to ensure a pleasant and fresh environment.



## EASY TO MOVE AND STABILIZE

For easy relocation, the booth is equipped with wheels. Once positioned correctly, the adjustable feet can be lowered to stabilize and level the booth.

## AUTOMATIC AIR FLOW

For the best possible oxygen environment inside the booth, it features automatic ventilation that ensures the air you breathe is always fresh and clean. Sensors detect when the booth is opened and increase the airflow speed accordingly. When not in use, the system quickly purges the air before entering a standby mode to reduce airflow, thereby saving energy resources.



## WORK IN A DISTRACTION FREE ZONE

The booth is designed for efficient work in a peaceful environment, ideal for making phone calls or conducting digital meetings. It also offers the convenience of charging stations for phones and laptops if needed.



## PROPERTIES

- A-Classed, 31,2 dB
- The inner walls are covered with felt material, choose between color beige or light grey
- Automatic ventilation
- Dimmable LED lighting
- Black laminate "finger print proof"
- Carpet in dark grey needle felt
- 8.76 mm acoustic lamellar glass
- Wheels and stand
- Choose outer shell in laminate or fabric covered
- Charging USB-C and power outlet
- The door is left-hung, cannot be changed



## INTERIOR

### TABLE

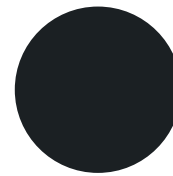

Table in black nanolaminate.  
Table height: 1100 mm  
Depth: 380/226 mm  
Width: 972 mm.

### WALLS IN TEXTILE FELT



-8 Ivory

### FLOOR

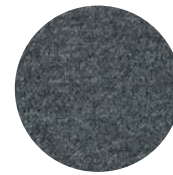

Dark grey carpet felt.  
Dimensions: 1016x1016 mm.



-1 Gravel



## EXTERIOR

### LAMINATE FROM KRONOSPAN



Oak laminate  
(Honey Costello oak  
K358 PW)

### TEXTILE CARLOW FROM CAMIRA

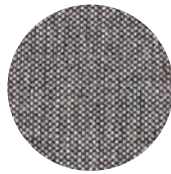

Colour 220  
(Convoy CLW09)

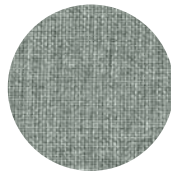

Colour 223  
(Tallow CLW01)

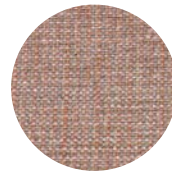

Colour 224  
(Callan CLW05)



Colour 228  
(Quin CLW04)

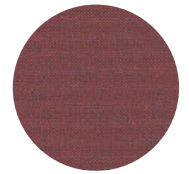

Colour 229  
(Redcross CLW08)

OR



Black laminate  
(Charcoal Arvadonna Chestnut  
K534 AD)

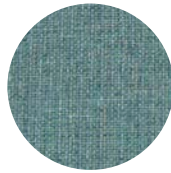

Colour 221  
(Cavan CLW15)

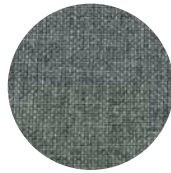

Colour 222  
(Parteen CLW23)

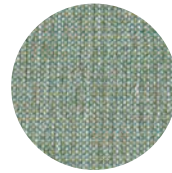

Colour 225  
(Carrick CLW18)

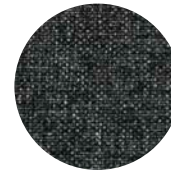

Colour 226  
(Avoca CLW22)

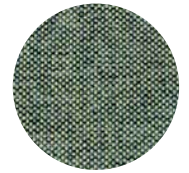

Colour 227  
(Emily CLW21)



## VENTILATION – SUPPLY AIR

Sound level	55 dBA (not built-in)
Nominal voltage	230 V
Alternating or direct current	AC
Operating voltage	min. 200 V
Operating voltage	max. 240 V
Flow rate	271.8 m³/h
Fan speed	2500 min <sup>-1</sup>

### DEFAULT FAN MODE

In use = 50%. 3 min after leaving the booth 100%  
10 min after leaving the booth 10%

## POWER

USB-C	Yes (45 W)
Power outlet	Yes (1 pc)

## LIGHTING

Luminaire lumen (lm)	60
Light source	LED
Light source included	Yes
Exchangeability	Yes
Light color	Warm white
Color temperature	3000
Color rendering (Ra)	>90
Color tolerance (SDCM)	3
Brightness (cd)	95
Spread angle (°)	45
Light distribution	Symmetrical
Light distribution	Direct
Number of light sources (pcs)	5
Number of LEDs (pcs)	1
Lifespan	90,000 h

## ACOUSTICS

Soundproofing	Class A* (31,2 dB speech level reduction)
---------------	---

\* Tested according to ISO 23351-1:2020



## CASA UNO

Casa uno is a phone booth for a person who wants privacy for an important phone call or for undisturbed work. Here you will find a fixed table for your computer, power socket, charging socket, pleasant dimmable lighting and as an option there is a bar stool. For the best possible oxygen environment inside the booth, there is automatic ventilation that ensures the air you breathe is always fresh and clean.



## CASA UNO

### Casa uno

110120	dressed with textile	11164,00
110121	oak laminate	10526,00
110122	black laminate	10526,00

External dimensions: W. 1204 H. 2325 D. 1204

Internal dimensions: W. 1016 H. 2040 D. 1016

### HOW TO ORDER CASA:

1: Choose Casa model: external material, choose between textile, oak laminate or black laminate.

Example: 110120 (Casa covered with textile).

2: Choose color of external material:

Example: 110120-229 (Redcross CLW08).

3: Choose color of interior material in Felt.

Example: 110120-229-8 (Ivory).

The floor is dark grey felt, the table is in black nano-laminate.

### Freight costs

9803

net price 531,00



It is possible to book a meeting in the Casa. This is done via our partner Awaio. See more information at [www.awaio.com](http://www.awaio.com).

"Awaio takes care of the existing office, organizes and shares it in an app. Awaio makes your office options fit your work life, not the other way around. Work wherever you want!"

## CASA STOOL

### Casa Stool

Base in black metal. The seat of the stool is Ø 400 mm and the foot is Ø 380 mm.

170010-201	H. 750	Ø 400	Lido 17	531,00
170010-202	H. 750	Ø 400	Lido 148	531,00
170010-203	H. 750	Ø 400	Lido 71	531,00
170010-205	H. 750	Ø 400	Lido 134	531,00
170010-209	H. 750	Ø 400	Lido 7	531,00

## TEXTILE LIDO BY NEVOTEX

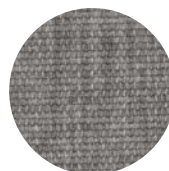

Colour 201  
(17 Concrete)

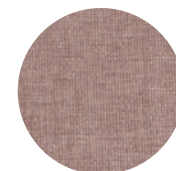

Colour 202  
(148 Orchid)



Colour 203  
(71 Plum)

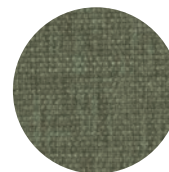

Colour 205  
(134 Antique Green)

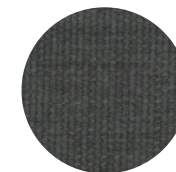

Colour 209  
(7 Grafit)



## LEVEL

Open the door to a great workspace, wherever you are. Level is the office for compact living, for open spaces, or for temporary visitors. With a design that easily can be used for several needs and with excellent ergonomics in a small space. The cabinet comes in three different variants, all with a grey frame but with different doors. Choose between Wood Ash veneer, Wood Ash veneer with a mirror, or the Solid Grey model, which is ready to be painted or wallpapered. With its height-adjustable desktop, built-in sound absorber, and the option for customized lighting, Level is designed for work that is good for both body and mind. The cabinet is prepared for electrical and USB outlets, wireless chargers, laptop holders, monitor arms.



## LEVEL

### Level

*Dimensions: 80.2 x 25.8 x 187 cm.*

*Table top dimensions: 75.4x62.1 cm.*

*Raised and lowered table top (min 72 cm – max 118.5 cm).*

*Built-in sound absorber in light grey.*

*Selectable exterior (wood ash, mirror ash, solid grey).*

*Cabinet frame in MDF.*

*Chipboard doors.*

*W. 80.2 H. 187.0 D. 25.8*

892012

892013

892014

wood ash

mirror ash

solid grey

Contact us  
for price

The product comes fully assembled except for the doors, which are assembled by the customer. Any accessories are also assembled by the customer.



Spring Birds  
Item no. GTS01

Concrete Wall  
Item no. GTS02

Tree  
Item no. GTS03

Coloured Mountain  
Item no. GTS04

Landscape  
Item no. GTS05

Gradient Painting  
Item no. GTS06

Jungle Wall Animals  
Item no. GTS07

## LEVEL

Suggested wallpaper is from Boråstapeter. See more information at [www.borastapeter.com](http://www.borastapeter.com). Ordered separately by customer.

## ACCESSORIES LEVEL



Simple laptop shelf in sheet metal where you attach your laptop with the help of a rubber band. The shelf follows the table upside down and minimizes the risk of cables getting tangled.

### Level Laptop shelf

Material: sheet metal. Rubber band included. Screw included for mounting in pre-drilled holes.

673300-1 W. 350 H. 320 white 39,15

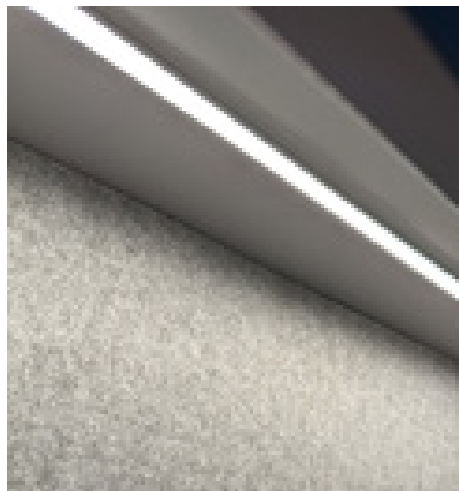
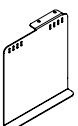

A combination of work lighting and decorative lighting. Dimmable LED strip that provides a pleasant light to work in.

### Level LED-list

On/Off button and dimmer, 400 lux. 2700 Kelvin.

821300 W. 715 91,70



Max weight capacity monitor arm 8 kg. Desk clamp included. Max table thickness 65 mm. Also suited for through desk mount (standard 80 mm) and Ø 10 mm. Incl. VESA attachment standard 75 and 100, rotates 360° and is tiltable.

### V4 Monitor arm

610710	H. 400	silver	166,28
610710-1	H. 400	white	166,28
610710-2	H. 400	black	166,28

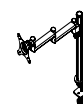



## THE HUT GEM WITH DESK

The sound-absorbing house The Hut with an integrated desk makes it even easier to quickly offer a workplace or a meeting room with space for your computer or notebook. Electrical outlets or other electrical products can advantageously be mounted in the desk. Surface material on desk is laminate. The house's simple and straight lines are inspired by the classic Monopoly game and it's pieces, which gives a timeless shape for the popular and practical "room within a room" concept.



## THE HUT GEM

Height of the desk 940 mm from floor, depth 800 mm. Fits bar stool with seat height 650 mm. Cable channel for lamp included, lamp is purchased separately. Thickness 40 mm.

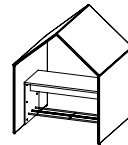

### The Hut GEM with desk

Including black footrest.  
111010-

See price ranges in textile chapter.

Pricer. 1	Pricer. 2	Pricer. 3	Pricer. 4
5096,17	5623,94	6855,53	9963,62

External dimensions: W.1880 H.2270 D.1800.  
Internal dimensions: W.1800 H.2220 D.1800.

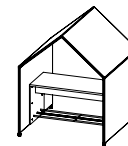

### The Hut GEM with desk and wheels

Including black footrest and black lockable wheels.  
111020-

5272,13	5858,51	7031,38	10139,57
---------	---------	---------	----------

External dimensions: W.1880 H.2270 D.1800.  
Internal dimensions: W.1800 H.2220 D.1800.

### Laminate

911 oak  
912 walnut  
913 white  
914 black  
915 ash



oak



walnut



white



black



ash

### ORDER THE HUT GEM:

1. Choose The Hut GEM or Half a Hut GEM.
2. Choose textile and colour.
3. Choose laminate.

Example: The Hut GEM with desk-event screen 60021-walnut laminate, 111010-06-912.





HALF A HUT GEM WITH DESK



SCRIBBLE WRITING BOARD THE HUT GEM

Attach the stylish and practical writing board on your The Hut GEM and use for all kind of meetings and information. The board's front is made of hardened tempered glass with a plate of sheet metal on the back, making it possible to both write on the glass and attach papers with magnets. Concealed suspension.



MAGAZINE +

Magazine+ is a magazine shelf for The Hut GEM and Half a Hut GEM with room for magazines. Perfect for easily accessible reading during your lunch or coffee break.

## HALF A HUT GEM

Height of the desk 940 mm from floor, depth 800 mm. Fits bar stool with seat height 650 mm. Cable channel for lamp included, lamp is purchased separately. Thickness 40 mm.

### Half a Hut GEM with desk

Including black footrest.  
111030-

See price ranges in textile chapter.

Pricer. 1	Pricer. 2	Pricer. 3	Pricer. 4
4040,64	4333,83	5506,70	7324,68

External dimensions: W.1880 H.2270 D.900.

Internal dimensions: W.1800 H.2220 D.900.

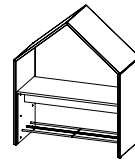

### Half a Hut GEM with desk and wheels

Including black footrest and black lockable wheels.  
111040-

4216,49	4509,79	5682,66	7500,53
---------	---------	---------	---------

External dimensions: W.1880 H.2270 D.900.

Internal dimensions: W.1800 H.2220 D.900.

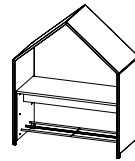

## ACCESSORIES

### Scrabble writing board

Magnetic writing board with tempered safety glass and sheet metal back.

101013	W. 800	H. 350	D. 4	white	290.43
101013-1	W. 800	H. 350	D. 4	sand	356.17
101013-2	W. 800	H. 350	D. 4	mist	356.17

### Magazine +

Magazine shelf for The Hut GEM/Half a Hut GEM. Screw included.  
Material: lacquered metal.

637208-1	W. 800	H. 220	D. 45	white	98.09
637208-2	W. 800	H. 220	D. 45	black	98.09

Mounting: make a hole in the fabric where the insert nut are placed to be able to mount the rail on which the writing board/Magazine + is hung. Rail and screw included.



The sound absorbing house can be used as an individual work station, a small sit or stand meeting room or a relax zone with The Hut Sofa. The house's simple and straight lines are inspired by the classic Monopoly game and it's pieces, which gives a timeless shape for the popular and practical "room within a room" concept.



Complement with front screens at The Hut, which gives a more enveloping impression.



The Hut Lamp provides nice lighting in The Hut and fits just as well with The Hut as with Half a Hut.

## THE HUT

See price ranges in textile chapter.

**The Hut with cable channel**  
110280-

Pricer. 1	Pricer. 2	Pricer. 3	Pricer. 4
4232,77	4565,64	6306,91	9410,96

Out. meas: W. 1880 H. 2270 D. 1800 In. meas: W. 1790 H. 2220 D. 1760

Info: Prices above are with the same textile on both sides.  
If you want different combinations of textiles, please contact us for a price.

## THE HUT WITH FRONT SCREENS

**The Hut with cable channel**  
110800-

6175,00	6860,21	8377,66	10528,09
---------	---------	---------	----------

Out. meas: W. 1880 H. 2270 D. 1860 In. meas: W. 1790 H. 2220 D. 1760

Info: Prices above are with the same textile on both sides.  
If you want different combinations of textiles, please contact us for a price.

### How to order:

1. Select type of The Hut.
2. Select textile (see colour map in the textile chapter).

### EXAMPLE

The Hut with cable channel - 148 Orchid from Lido 110280 - 202

## THE HUT LAMP



### The Hut Lamp

5 m black textile-covered cord with switch and E27 socket. 3-step click attenuation, the light effect is easily changed by clicking on the switch

821020

142.77



A sound-absorbing smaller room that fits well in larger rooms where there is a need for shielding office space.

## HALF A HUT

See price ranges in textile chapter.

Half a Hut with cable channel 110420-	Pricer. 1	Pricer. 2	Pricer. 3	Pricer. 4
	3433,72	3549,15	5132,55	7003,83

Out. meas: W. 1880 H. 2270 D. 900 In. meas: W. 1790 H. 2220 D. 860

Info: Prices above are with the same textile on both sides.  
If you want different combinations of textiles, please contact us for a price.



A sound-absorbing smaller room with front screens for a more enveloping impression.

## HALF A HUT WITH FRONT SCREEN

Half a Hut with cable channel 110880-	4128,62	4312,87	5756,06	7623,51

Out. meas: W. 1880 H. 2270 D. 960 In. meas: W. 1790 H. 2220 D. 860

Info: Prices above are with the same textile on both sides.  
If you want different combinations of textiles, please contact us for a price.

### How to order:

1. Select type of Half a Hut.
2. Select textile (see colour map in the textile chapter).

Example:

Half a Hut with cable channel - 148 Orchid from Lido 110420 - 202



The Open Huts are two more siblings in our popular Hut family. With front screens on both sides, they work as airy room within the rooms in both the office landscape as well as the hotel entrance. Add one or two The Hut/Half a Hut Sofas inside for a nice meeting place or a screened off work space.

## OPEN HUT

Open Hut with cable channel *See price ranges in textile chapter.*  
**Pricer. 1** **Pricer. 2** **Pricer. 3** **Pricer. 4**  
 110200- | 6588,72 | 7283,72 | 9104,26 | 10913,30 |

Out. meas: W. 1880 H. 2270 D. 1880 In. meas: W. 1790 H. 2220 D. 1760



### Bright

*Dimmable LED lamp and brass base. 5 m black decorative textile cable. Has unearthed plug. (Dimmer not included.) See more information in the Lighting Chapter.*

821025

187.77



### Pocket Table

*The table is available in three combinations: oak veneer with a white stand, oak veneer with a black stand and black lacquered oak veneer with a black stand. Pocket in artificial leather.*

891041	W. 580	H. 665	D. 380	oak/white	533.09
891042	W. 580	H. 665	D. 380	oak/black	533.09
891043	W. 580	H. 665	D. 380	black/black	533.09

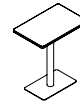

### No Pocket Table

*The table is available in three combinations: oak veneer with a white stand, oak veneer with a black stand and black lacquered oak veneer with a black stand.*

*W. 580 H. 665 D. 380*

891044				oak/white	410.00
891045				oak/black	410.00
891046				black lacquered/black	410.00



Open Half a Hut is another variant in our popular Hut family. Works as an airy room in the room and has room for 2 The Hut Sofa. Excellent for relaxed meetings or a screened off work.

## OPEN HALF A HUT

Open Half a Hut with cable channel *See price ranges in textile chapter.*  
**Pricer. 1** **Pricer. 2** **Pricer. 3** **Pricer. 4**  
 110210- | 4830,74 | 5359,68 | 6847,98 | 8327,13 |

Out. meas: W. 1880 H. 2270 D. 980

In. meas: W. 1790 H. 2220 D. 860



### The Hut Lamp

*5 m black textile-covered cord with switch and E27 socket. 3-step click attenuation, the light effect is easily changed by clicking on the switch.*

821020

142.77

### How to order:

- 1 Choose Open Hut or Open Half a Hut.
  2. Choose textile and colour, see the textile chapter.
- Example: Open Hut - Kinship from Synergy 110200 - 622

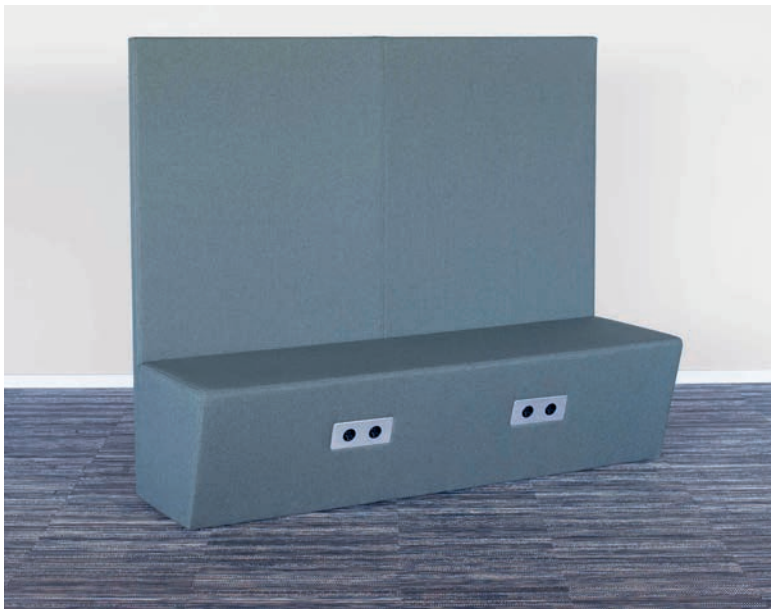

## THE HUT SOFA

See price ranges in textile chapter.

	Pricer. 1	Pricer. 2	Pricer. 3	Pricer. 4
<b>The Hut Sofa</b> 647110- W. 1760 H. 1450 D. 550	2520,00	2660,11	3224,68	4218,09
<b>The Hut Sofa, Table Top white</b> 647111- W. 1760 H. 1450 D. 550	2673,30	2841,49	3378,19	4357,23
<b>The Hut Sofa, Table Top black</b> 647113- W. 1760 H. 1450 D. 550	2673,30	2841,49	3378,19	4357,23
<b>The Hut Sofa, Table Top silver</b> 647118- W. 1760 H. 1450 D. 550	2673,30	2841,49	3378,19	4357,23

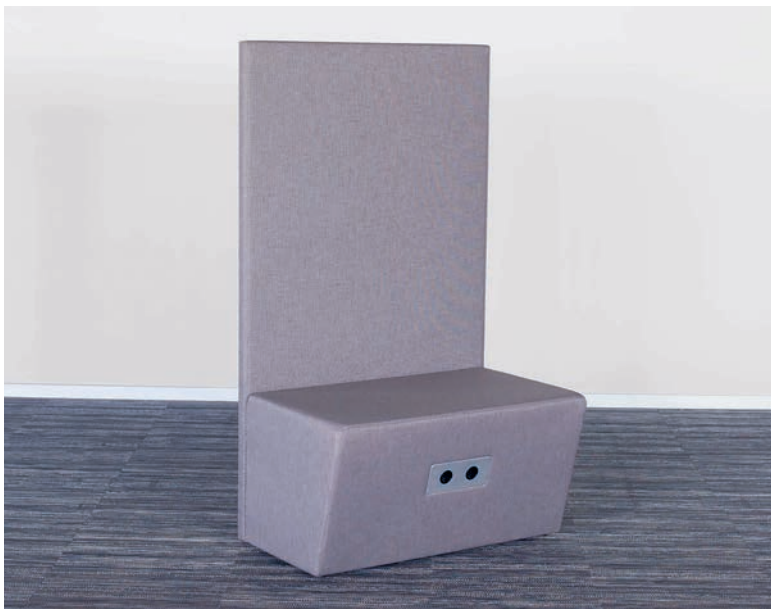

## HALF A HUT SOFA

See price ranges in textile chapter.

	Pricer. 1	Pricer. 2	Pricer. 3	Pricer. 4
<b>Half a Hut Sofa</b> 647130- W. 860 H. 1450 D. 550	1723,83	1839,89	2166,06	2479,57
<b>Half a Hut Sofa, Table Top white</b> 647131- W. 860 H. 1450 D. 550	1824,89	1954,47	2272,87	2577,77
<b>Half a Hut Sofa, Table Top black</b> 647133- W. 860 H. 1450 D. 550	1824,89	1954,47	2272,87	2577,77
<b>Half a Hut Sofa, Table Top silver</b> 647138- W. 860 H. 1450 D. 550	1824,89	1954,47	2272,87	2577,77

Note: External dimensions. Seat height: 450 mm. Seat depth: 500 mm.  
Half a Hut Sofa with Table Top includes 1 x 2 sockets.  
Table Top is a power outlet mounted in the sofa.

Prices apply to colours in the textile chapter. Textiles that can be selected:

Pricer. 1: Event Screen +, Houston Reflect, Mica, Omega, Pearl, Slope, Tonal  
Pricer. 2: Era, Kaiman, Lido, Noble lux, Rivet  
Pricer. 3: Ally, Blazer, Bond, Synergy  
Pricer. 4: Illusion II, Remix 3

Specify the article number as follow:

Sofa - textile colour (seam as textile)The Hut - textile colour (seam as textile)



## BACKREST

See price ranges in textile chapter.

	Pricer. 1	Pricer. 2	Pricer. 3	Pricer. 4
<b>Backrest Time Out</b> 657310- W. 1700 H. 350 D. 130	412,45	453,62	550,11	674,04
<b>Backrest The Hut Sofa</b> 657320- W. 1740 H. 350 D. 130	412,45	453,62	550,11	674,04
<b>Backrest Half a Hut Sofa</b> 657330- W. 840 H. 350 D. 130	260,96	274,79	329,89	384,79

How to order:

Specify the article number as follow:

Backrest - textile colour (seam as textile colour).

Prices apply to colours in the textile chapter. Textiles that can be selected:

Pricer. 1: Event Screen +, Houston Reflect, Mica, Omega, Pearl, Slope, Tonal  
Pricer. 2: Era, Kaiman, Lido, Noble lux, Rivet  
Pricer. 3: Ally, Blazer, Bond, Synergy  
Pricer. 4: Illusion II, Remix 3



## THE HUT LOUNGE

### The Hut Lounge

The Hut Lounge always has a cable channel.

Must always be connected with 2 The Hut Bench.

See price ranges in textile chapter.

	Pricer. 1	Pricer. 2	Pricer. 3	Pricer. 4
110902-	4232,77	4565,64	6306,91	9410,96

Out. meas: W. 1880 H. 2270 D. 1800 In. meas: W. 1800 H. 2220 D. 1800.  
The specified height includes a mounted Bench.

## HALF A HUT LOUNGE

### Half a Hut Lounge

Must always be connected with 1 The Hut Bench.

See price ranges in textile chapter.

	Pricer. 1	Pricer. 2	Pricer. 3	Pricer. 4
110905-	3433,72	3549,15	5132,55	7003,83

Out. meas: W. 1880 H. 2270 D. 900 In. meas: W. 1800 H. 2220 D. 900.  
The specified height includes a mounted Bench.

#### ORDER PROCEDURE:

1. Select The Hut Lounge or Half A Hut Lounge
2. Choose textile, see textile chapter.
3. Choose 2 Benches with or without Table Top for The Hut Lounge or 1 Bench for Half A Hut Lounge with or without Table Top.
4. Choose textile, see textile chapter.
5. Choose Bench Cover that fits the amount and size of your bench(es).
6. Choose textile. See below which textiles that are available for Bench Covers:

#### Order example:

The Hut Lounge - Textile (seam as textile) 110902 - 02  
2 x The Hut Bench with black Table Top - Textile (seam as textile)  
2 x 110913 - 02 Double Bench Cover - Textile (seam as textile)  
110940 - 02 Half a Hut Lounge - 108 Event Screen +

#### Prices apply to colours in the textile chapter. Textiles that can be selected:

Pricer. 1: Event Screen +, Houston Reflect, Mica, Omega, Pearl, Slope, Tonal  
Pricer. 2: Era, Kaiman, Lido, Noble lux, Rivet  
Pricer. 3: Ally, Blazer, Bond, Synergy  
Pricer. 4: Illusion II, Remix 3



## THE HUT BENCH

### THE HUT BENCH

*The Hut Bench is always fitted with wheels. The Hut Bench must always be connected to a The Hut Lounge/Half a Hut Lounge.* See price ranges in textile chapter.

		Pricer. 1	Pricer. 2	Pricer. 3	Pricer. 4
	<b>The Hut Bench</b> 110910- W. 1800H. 450 D. 900	1779,79	1883,19	2216,81	2652,02
	<b>The Hut Bench, Table Top white</b> 110911- W. 1800H. 450 D. 900	1963,40	2066,91	2400,53	2835,64
	<b>The Hut Bench, Table Top black</b> 110913- W. 1800H. 450 D. 900	1963,40	2066,91	2400,53	2835,64
	<b>The Hut Bench, Table Top silver</b> 110918- W. 1800H. 450 D. 900	1963,40	2066,91	2400,53	2835,64

Note: The Hut Bench with Table Top includes 2 x 2 sockets. Table Top is a power outlet mounted in the bench. Max load 400 kg per Bench. Bench height includes mattress and wheels.



Bench – the key object in three formats as a part of The Hut Lounge collection. Place a Free Bench in the entrance fitted with Table Top to meet every visitor's wish. Combine the Square Bench with any constellation to create dynamic and add an extra nice design detail.



## FREE BENCH AND SQUARE BENCH

### FREE BENCH

*Square Bench is always fitted with wheels. Can be used as free standing or connected to other Benches.*

	<b>Free Bench</b> 110920- W. 1800 H. 450 D. 900	1779,79	1883,19	2216,81	2652,02
	<b>Free Bench, Table Top white</b> 110921- W. 1800 H. 450 D. 900	1963,40	2066,91	2400,53	2835,64
	<b>Free Bench, Table Top black</b> 110923- W. 1800 H. 450 D. 900	1963,40	2066,91	2400,53	2835,64
	<b>Free Bench, Table Top silver</b> 110928- W. 1800 H. 450 D. 900	1963,40	2066,91	2400,53	2835,64



Note: The Hut Bench with Table Top includes 2 x 2 sockets. Table Top is a power outlet mounted in the bench. Max load 400 kg per Bench. Bench height includes mattress and wheels.

### SQUARE BENCH

*Square Bench is always fitted with wheels. Can be used as free standing or connected to other Benches.*

	110930- W. 900H. 450 D. 900	1279,79	1325,96	1562,34	1836,91
--	-----------------------------	---------	---------	---------	---------

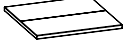
### BENCH COVERS

	<b>Bench Cover</b> 110950- W. 1800 H. 80 D. 900	605,74	739,57	887,13	1030,21
	<b>Double Bench Cover</b> Always has decor seam in the middle. 110940- W. 1800 H. 80 D. 1800	903,72	1261,49	1375,85	1781,91
	<b>Square Bench Cover</b> 110960- W. 900 H. 80 D. 900	403,51	486,91	560,96	647,45

Prices apply to colours in the textile chapter. Textiles that can be selected:  
 Pricer. 1: Event Screen +, Houston Reflect, Mica, Omega, Pearl, Slope, Tonal  
 Pricer. 2: Era, Kaiman, Lido, Noble lux, Rivet  
 Pricer. 3: Ally, Blazer, Bond, Synergy  
 Pricer. 4: Illusion II, Remix 3





Time Out is a modern sound absorbing sofa with a roof built with A30 screens. Choose with or without electric sockets to create relaxed work spaces or a comfortable place to charge your phone in the lobby. The sofa works excellent as a solitaire piece or in a group. Two Time Out placed opposite each other creates a nice and airy room in the room. Great to combine with Backrest and Pocket Table for a complete solution.

## TIME OUT



### Time Out

*See price ranges in textile chapter.*

	Pricer. 1	Pricer. 2	Pricer. 3	Pricer. 4
647150-	3393,72	3531,38	4405,74	5590,11

### Time Out, 2 Table Top white

647151-	3627,87	3765,53	4639,89	5824,15
---------	---------	---------	---------	---------

### Time Out, 2 Table Top black

647153-	3627,87	3765,53	4639,89	5824,15
---------	---------	---------	---------	---------

### Time Out, 2 Table Top silver

647158-	3627,87	3765,53	4639,89	5824,15
---------	---------	---------	---------	---------

Out. mesure. W. 1800 D. 900 H. 2222.

Note: External dimensions. Seat height: 450 mm. Seat depth: 500 mm. Time Out with Table Top includes 2 mounted sockets. Table Top is a power outlet mounted in the sofa.

### HOW TO ORDER TIME OUT:

Article number: Time Out - textile - zip (seam like zip's edge).

Example: 647153-253-113 Time Out incl 2 pc Table Top black in Slope 33 Crystal with silver grey/brown fishbone zip (seam will be grey/brown).



## SOFA SILENT GROUP

See price ranges in textile chapter.

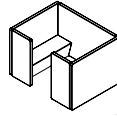

Sofa Silent Group	Pricer. 1	Pricer. 2	Pricer. 3	Pricer. 4
647300-	7947,98	8152,13	10223,72	11814,47
W. 2200 H. 1400 D. 1700				

Sofa Silent Group, Table Top white	Pricer. 1	Pricer. 2	Pricer. 3	Pricer. 4
647311-	8567,87	8772,02	10843,72	12434,26
W. 2200 H. 1400 D. 1700				

Sofa Silent Group, Table Top silver	Pricer. 1	Pricer. 2	Pricer. 3	Pricer. 4
647313-	8567,87	8772,02	10843,72	12434,26
W. 2200 H. 1400 D. 1700				

Sofa Silent Group, Table Top black	Pricer. 1	Pricer. 2	Pricer. 3	Pricer. 4
647318-	8567,87	8772,02	10843,72	12434,26
W. 2200 H. 1400 D. 1700				

Note: External dimensions. Seat height: 450 mm. Seat depth: 500mm. Sofa Silent Group with Table Top includes 4 x 2 sockets.

Prices apply to colours in the textile chapter. Textiles that can be selected:

Pricer. 1: Event Screen +, Houston Reflect, Mica, Omega, Pearl, Slope, Tonal  
 Pricer. 2: Era, Kaiman, Lido, Noble lux, Rivet  
 Pricer. 3: Ally, Blazer, Bond, Synergy  
 Pricer. 4: Illusion II, Remix 3

Specify the article number as follow:  
 Sofa - textile colour - zip colour (seam as zip edgings)

Sofa Silent Group forms a room within an open landscape, in the hotel lobby as well as in public areas. The group consists of 80 mm thick screen walls which makes it to a very quiet place for meetings and relaxation.





# WHITEBOARDS, NOTICE BOARDS, WRITING BOARDS

**S**tylish and practical writing and notice boards are a must for all creative meetings.

We have a variety of solutions to offer; independent on wheels, hung on screens or maybe placed in The Hut. Our mounted writing boards are great sound absorbers and offer the perfect place for pins, magnets or metal lists.



Scribble is our new whiteboard with hidden mounting fittings that makes the board more clean and stylish. Mount directly on the wall or choose the models attached to A40 screens. On wall or with feet to stand on floor.



## SCRIBBLE WRITING BOARD

### Scribble writing board

Magnetic writing board made of tempered glass. Sheet metal back. Concealed wall suspension for blackboard included.

101014	W. 990	H. 990	D. 4	white	608.19
101014-1	W. 990	H. 990	D. 4	sand	717.77
101014-2	W. 990	H. 990	D. 4	mist	717.77
101025	W. 990	H. 1590	D. 4	white	980.74
101025-1	W. 990	H. 1590	D. 4	sand	1090.32
101025-2	W. 990	H. 1590	D. 4	mist	1090.32
101024	W. 1590	H. 990	D. 4	white	980.74
101024-1	W. 1590	H. 990	D. 4	sand	1090.32
101024-2	W. 1590	H. 990	D. 4	mist	1090.32

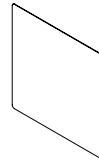

### Scribble writing board

Magnetic writing board made of tempered glass. Sheet metal back. Concealed wall suspension for blackboard included.

101015	W. 250	H. 250	D. 4	white	213.72
101015-1	W. 250	H. 250	D. 4	sand	213.72
101015-2	W. 250	H. 250	D. 4	mist	213.72

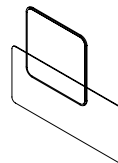

### Scribble writing board

Magnetic writing board with tempered safety glass and sheet metal back.

101013	W. 800	H. 350	D. 4	white	290.43
101013-1	W. 800	H. 350	D. 4	sand	356.17
101013-2	W. 800	H. 350	D. 4	mist	356.17

Mounting: make a hole in the fabric where the insert nut sits to be able to screw on a suspension strip on which the writing board/Magazine + is hung. Strip and screw included.



Writing board white.



Writing board sand.



Writing board mist.



## A40 SCRIBBLE´N PIN

### A40 Scribble´n pin

The screen is made up of a wooden frame, 40 mm sound absorber and 5 mm foam laminated textile. Total thickness 50 mm.

Writing board and wall bracket are ordered separately.

530191 - fits glass writing board 990x990

536191 - fits glass writing board 1590x990

536192 - fits glass writing board 990x1590

See price ranges in textile chapter.

With seam	Pricer. 1	Pricer. 2	Pricer. 3	Pricer. 4
530191 - W. 1400 H. 1000	509,04	563,72	717,02	935,96
536191 - W. 2000 H. 1000	727,98	793,62	979,79	1253,40
536192 - W. 1400 H. 1600	738,94	837,45	1045,43	1373,83
With zip				
530191 - W. 1400 H. 1000	552,77	607,55	760,85	1012,55
536191 - W. 2000 H. 1000	771,70	837,45	1034,47	1297,23
536192 - W. 1400 H. 1600	782,66	881,17	1089,26	1428,51

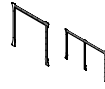
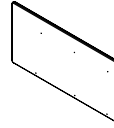

### Scribble wall mount kit

Mounted together with Scribble´n Pin wall. Two people are required.

649003	W. 950	H. 960	D. 30	white	96.28
649004	W. 1550	H. 960	D. 30	white	101.81

## SCRIBBLE FLOORSCREEN

### Scribble writing board floor screen

The screen is made of wooden frame, 40 mm sound absorber and 5 mm foam laminated textile. Total thickness 50 mm. Writing board and foot package ordered separately.

530181 - fits writing board 990x990

536182 - fits writing board 990x1590

536181 - fits writing board 1590x990

See price ranges in textile chapter.

With seam	Pricer. 1	Pricer. 2	Pricer. 3	Pricer. 4
530181 - W. 1000 H. 1800	574,68	651,38	881,17	1100,11
536182 - W. 1000 H. 1800	695,11	727,98	892,13	1143,94
536181 - W. 1600 H. 1800	706,06	815,53	1143,94	1461,38
With zip				
530181 - W. 1000 H. 1800	629,47	695,11	925,00	1122,02
536182 - W. 1000 H. 1800	727,98	793,62	946,91	1198,72
536181 - W. 1600 H. 1800	749,89	859,36	1198,72	1494,26

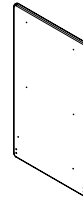

### Foot set with wheels for floor screen

Lockable wheels. 4 in one pack.

643060-1	white -2 black -3 silver	233.51
----------	--------------------------	--------



### Foot set Woodland for Floorscreen A40/Sketch/Scribble

Foot in molded wood with whitewashed ash veneer and metal fittings.

4 feet included.

643066-1	white*/whitewashed ash	257.98
643066-2	black*/whitewashed ash	257.98
643066-3	silver*/whitewashed ash	257.98



### Foot Set Slide-in Woodland with wheels for A40/Sketch/Scribble Floor screen

Foot set in molded wood with whitewashed ash veneer and metal fittings.

4 feet with wheels included. The wheels are lockable.

643065-1	white*/whitewashed ash	335.43
643065-2	black*/whitewashed ash	335.43
643065-3	silver*/whitewashed ash	335.43

\* Colour indicates wheels and fittings.

Stylish and practical writing board with hidden attachment to screen. The glass surface is made of tempered safety glass with a magnetic surface, which makes it easy to both attach paper and write directly on the board. The board on floor screen has four rotatable and lockable wheels that allow you to quickly switch from a writing board to a sound-absorbing notice board where you can conveniently attach pictures and documents with pins..

#### Order procedure for Scribble´n Pin:

1. Chose screen. Specify the article number for the screen as follow: Screen - fabric colour - zip/seam colour.

Example: 536191-01-101.

2. Order writing board.

#### Order procedure for Scribble writing board floorscreen on wheels:

1. Chose screen Specify the article number for the screen as follow:

Screen - fabric colour - zip/seam colour.

Example: 536181-01-101.

2. Order writing board.

3. Order foot set.

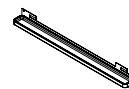

### Scribble pen shelf Woodland

Material: solid whitewashed ash.

637165 - fits writing board 990 mm.

637166 - fits writing board 1590 mm.

637165	W. 930	H. 70	D. 82	whitewashed ash/white	160.00
637166	W. 765	H. 70	D. 82	whitewashed ash/white	160.00

### Scribble pen shelf

Material: metal.

637167 - fits writing board 990 mm.

637168 - fits writing board 1590 mm.

637167-1	W. 930	H. 70	D. 61	white	41.49
637167-2	W. 930	H. 70	D. 61	black	41.49
637168-1	W. 765	H. 70	D. 61	white	41.49
637168-2	W. 765	H. 70	D. 61	black	41.49

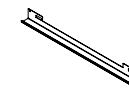



The Sketch Pin A40 is a stylish and practical writing board with a glass slide mounted on a ScreenIT A40. Mounted on the wall. Attach paper with magnets or write directly on the board. Pin with needles on the wall screen next to the writing board.



## SKETCH'N PIN A40

### Sketch'n Pin A40

The wall screen is made of a wooden frame, 40 mm sound absorber and 5 mm foam-laminated textile on each side. Total thickness 50 mm. Wall bracket included in the writing board. Writing board purchased separately

See price ranges in textile chapter.

	Pricer. 1	Pricer. 2	Pricer. 3	Pricer. 4
<b>With seam</b>				
530190- W. 1400 H. 1000	485,96	543,62	761,17	946,91
536190- W. 2000 H. 1000	703,83	767,77	1023,83	1228,72
<b>With zip</b>				
530190- W. 1400 H. 1000	530,74	588,40	806,17	991,81
536190- W. 2000 H. 1000	748,51	812,45	1068,62	1273,51

### Order procedure for Sketch'n Pin:

1. Chose screen Specify the article number for the screen as follow:  
Screen - fabric colour - zip/seam colour.  
Example: 536190-01-101.
2. Order writing board.

## SKETCH'N PIN WRITING BOARD

### Sketch'n Pin writing board

Writing board in glass to mount on Sketch'n Pin A40 1400x1000 mm.  
Front: tempered safety glass. Back: sheet metal. Wall bracket included.

101012	W. 990	H. 990	D. 4	white	750.64
101012-1	W. 990	H. 990	D. 4	sand	851.38
101012-2	W. 990	H. 990	D. 4	mist	851.38
101012-3	W. 990	H. 990	D. 4	olive	851.38
101012-4	W. 990	H. 990	D. 4	ocean	851.38
101012-6	W. 990	H. 990	D. 4	lilac	851.38
101012-7	W. 990	H. 990	D. 4	harvest	851.38

### Sketch'n Pin writing board

Writing board in glass to mount on Sketch'n Pin A40 2000x1000 mm.  
Front: tempered safety glass. Back: sheet metal. Wall bracket included.

101022	W. 1590	H. 990	D. 4	white	1111.91
101022-1	W. 1590	H. 990	D. 4	sand	1212.98
101022-2	W. 1590	H. 990	D. 4	mist	1212.98
101022-3	W. 1590	H. 990	D. 4	olive	1212.98
101022-4	W. 1590	H. 990	D. 4	ocean	1212.98
101022-5	W. 1590	H. 990	D. 4	rhubarb	1212.98
101022-6	W. 1590	H. 990	D. 4	lilac	1212.98
101022-7	W. 1590	H. 990	D. 4	harvest	1212.98



Writing board white.



Writing board sand.



Writing board harvest.



Writing board olive.



Writing board rhubarb.

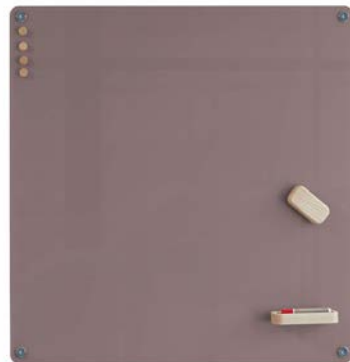

Writing board lilac.



Writing board mist.



Writing board ocean.



Attach the stylish and practical writing board to the wall and use for all kind of meetings and information. The board's front is made of hardened tempered glass with a plate of sheet metal on the back, making it possible to both write on the glass and attach papers with magnets. The board appears 30 mm from the wall when mounted.



## SKETCH WRITING BOARD WALL



### Sketch writing board wall

Writing board in glass to mount on wall. Screws included. Glass 4 mm.

101011	W. 990	H. 990	D. 4	white	750.64
101011-1	W. 990	H. 990	D. 4	sand	851.38
101011-2	W. 990	H. 990	D. 4	mist	851.38
101011-3	W. 990	H. 990	D. 4	olive	851.38
101011-4	W. 990	H. 990	D. 4	ocean	851.38
101011-6	W. 990	H. 990	D. 4	lilac	851.38
101011-7	W. 990	H. 990	D. 4	harvest	851.38

### Sketch writing board wall

Writing board in glass to mount on wall. Screws included. Glass 4 mm.

101021	W. 1590	H. 990	D. 4	white	1111.91
101021-1	W. 1590	H. 990	D. 4	sand	1212.98
101021-2	W. 1590	H. 990	D. 4	mist	1212.98
101021-3	W. 1590	H. 990	D. 4	olive	1212.98
101021-4	W. 1590	H. 990	D. 4	ocean	1212.98
101021-5	W. 1590	H. 990	D. 4	rhubarb	1212.98
101021-6	W. 1590	H. 990	D. 4	lilac	1212.98
101021-7	W. 1590	H. 990	D. 4	harvest	1212.98





Stylish and practical writing board on wheels. The glass surface is made of hardened tempered glass with magnetic surface, making it easy to attach both paper and write directly on the board. The board has four lockable wheels that allow you to switch quickly from whiteboard page to a sound-absorbing bulletin board, which conveniently attaches images and documents with needles.



## SKETCH WRITING BOARD FLOOR SCREEN



### Sketch writing board floor screen

Thickness A40= 50 mm.

See price ranges in textile chapter.

Pricer. 1 Pricer. 2 Pricer. 3 Pricer. 4

#### With seam

530180-	W. 1000 H. 1800	545,32	627,23	886,49	1077,66
536180-	W. 1600 H. 1800	681,81	791,06	1159,47	1432,45

#### With zip

530180-	W. 1000 H. 1800	589,68	671,60	931,06	1122,02
536180-	W. 1600 H. 1800	726,28	835,53	1204,04	1477,02

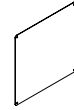

### Sketch writing board floor screen

Writing board in glass to mount on floor screen. Screws included.

Glass 4 mm. Designed for screen 1000 mm.

101010	W. 990 H. 990 D. 4	white	694,68
101010-1	W. 990 H. 990 D. 4	sand	795,74
101010-2	W. 990 H. 990 D. 4	mist	795,74
101010-3	W. 990 H. 990 D. 4	olive	795,74
101010-4	W. 990 H. 990 D. 4	ocean	795,74
101010-6	W. 990 H. 990 D. 4	lilac	795,74
101010-7	W. 990 H. 990 D. 4	harvest	795,74

### Sketch writing board floor screen

Writing board in glass to mount on floor screen and Moving Wall

Media. Screws included. Glass 4 mm. Designed for screen 1600 mm.

101016	W. 1590 H. 990 D. 4	white	1038,94
101016-1	W. 1590 H. 990 D. 4	sand	1139,47
101016-2	W. 1590 H. 990 D. 4	mist	1139,47
101016-3	W. 1590 H. 990 D. 4	olive	1139,47
101016-4	W. 1590 H. 990 D. 4	ocean	1139,47
101016-5	W. 1590 H. 990 D. 4	rhubarb	1139,47
101016-6	W. 1590 H. 990 D. 4	lilac	1139,47
101016-7	W. 1590 H. 990 D. 4	harvest	1139,47



### Foot set with wheels for floor screen

Lockable wheels. 4 in one pack.

643060-1	white -2 black -3 silver	233,51
----------	--------------------------	--------

Woodland foot package, see next page.

### Order procedure for Sketch writing board on wheels:

1. Chose screen Specify the article number for the screen as follow:

Screen - fabric colour - zip/seam colour.

Example: 536180-01-101.2. Order writing board.

3. Order foot set.

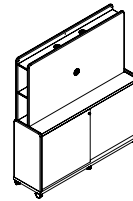

### Moving Wall Media

Reinforced screen for mounting of TV screen. Wooden details in laminate.

Max width TV: 65". Max weight TV: 35 kg.

W. 1650 H. 1800 D. 450

110030-	ash	5693,72	6346,81	7229,36	7605,64
110031-	oak	5693,72	6346,81	7229,36	7605,64
110032-	walnut	5693,72	6346,81	7229,36	7605,64
110033-	white	5693,72	6346,81	7229,36	7605,64

Sketch Writing Board Floor screen W. 1590 fits Moving Wall Media.



With the Woodland foot set for floor screens, you can add your own touch to the design. These designed feet in molded wood with whitewashed ash veneer and stylish metal fittings are available both with wheels to easily move the screen and without.

## FOOT SET WOODLAND

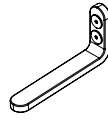

QQ

### Foot set Woodland for Floorscreen A30

Foot in molded wood with whitewashed ash veneer and metal fittings that fit A30 floor screen. 4 feet included.

643068-1	white*/whitewashed ash	257.98
643068-2	black*/whitewashed ash	257.98
643068-3	silver*/whitewashed ash	257.98

RR

### Foot set Woodland for Floorscreen A40/Sketch/Scribble

Foot in molded wood with whitewashed ash veneer and metal fittings. 4 feet included.

643066-1	white*/whitewashed ash	257.98
643066-2	black*/whitewashed ash	257.98
643066-3	silver*/whitewashed ash	257.98

\* Colour indicates fittings.



Foot set in molded wood with whitewashed ash veneer and metal fittings that fits floor screens. The wheels are lockable.

## FOOT SET WOODLAND

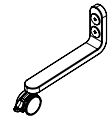

SS

### Foot set Woodland with wheels for Floorscreen A30

Foot set in molded wood with whitewashed ash veneer and metal fittings that fits A30 floor screen. 4 feet with wheels included. The wheels are lockable.

643067-1	white*/whitewashed ash	335.43
643067-2	black*/whitewashed ash	335.43
643067-3	silver*/whitewashed ash	335.43

TT

### Foot Set Slide-in Woodland with wheels for A40/Sketch/Scribble-Floor screen

Foot set in molded wood with whitewashed ash veneer and metal fittings. 4 feet with wheels included. The wheels are lockable.

643065-1	white*/whitewashed ash	335.43
643065-2	black*/whitewashed ash	335.43
643065-3	silver*/whitewashed ash	335.43

\* Colour indicates wheels and fittings.



**Magnets Woodland**

4-pack magnets for Sketch Writing board. Extra strong magnets with wood cover in solid whitewashed ash. Ø 25 H. 11

637122 whitewashed ash 66.17



**Pen holder Woodland**

Extra strong magnet for good hold on Sketch Writing Board. Solid whitewashed ash. W. 180 H. 30 D. 80

637123 whitewashed ash 92.87



**Eraser Woodland**

Extra strong magnet. Felt is mounted on Hook & Loop tape, change when matted. Solid whitewashed ash. W. 120 H. 33 D. 60

637121 whitewashed ash 79.68

**Whiteboard eraser felt refill 5 pcs**

Mount on Hook & Loop tape.

637130 grey 5.96



**Whiteboard pens, 4 pcs**

Colours: blue, red, black, green.

637131 17.98



**Pen shelf Woodland 1590 mm**

Material: solid whitewashed ash. W. 801 H. 83

637125 whitewashed ash 160.00

**Pen shelf Woodland 990 mm**

Material: solid whitewashed ash. W. 966 H. 83

637124 whitewashed ash 160.00



**Pen shelf for Sketch writing board 990 mm**

Pen shelf to mount on writing board. W. 966 H. 57

637118-1white -2 black -3 silver 40.43

**Pen shelf for Sketch writing board 1590 mm**

Pen shelf to mount on writing board. Only space for 1 shelf. W. 801 H. 57

637119-1white -2 black -3 silver 40.43

**Accessory kit for writing boards**

Content: wiper, 4 pens and 10 magnets.

101050 75.96

## STORYBOARD ECOSUND®

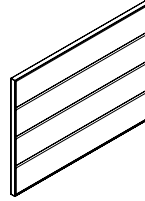

### Storyboard EcoSUND

Acoustic Nonwoven Hush Blazer Lite

125600- W. 1600 H. 1200	675,11	782,77	931,38
125601- W. 2400 H. 1200	971,91	1052,98	1147,45

Colour frame. 1=white, 2=black, 3=grey

### HOW TO ORDER STORYBOARD

Art.No - Colour frame - Colour fabric.

Example: 125600-1-567= Storyboard with white frame in blue Hush.

### Mounting strip Dikt for frame 1600 mm

List for wall mount.

341600	W. 1320	17.87
--------	---------	-------

### Mounting strip Dikt for frame 2400 mm

List for wall mount.

342400	W. 2120	26.49
--------	---------	-------

Important info: Storyboard can only be ordered in textiles Acoustic Nonwoven, Hush and Blazer Lite. See textiles and frames in textile chapter. For orders of W. 2400 mm, minimum quantity: 5 pcs.



The bulletin board for your documents. Attach documents with pins, on the metallic list or with magnets. All absorbents are 50 mm thick for good sound absorption and made of our unique core material EcoSUND. Choose textiles from Acoustic Nonwoven, Hush and Blazer Lite to match the rest of your furniture.

## WRITING BOARD FOR SCREENIT A30 AND SOFAS



### Writing board to hang over screens

Magnetic whiteboard in metal to hang over the screen.

648103	W. 700	H. 900	D. 53*	white	116.28
--------	--------	--------	--------	-------	--------

\* Information: The depth indicates the dimensions of the shelf.



Magnetic writing board with painted surface to hang over ScreenIT A30 floor screens and Sofa Sound Booth. The board is easy to clean and has a practical built-in pen shelf. Can not be used on Sofa Silent Group.



Collage is a two-in-one solution combining good acoustics with a practical notice board. Collage is manufactured in six standard formats. All absorbers are 50 mm thick for good sound absorption and made of our unique core material EcoSUND. Choose colour from textiles Acoustic Nonwoven, Hush or Blazer Lite to match the rest of your furniture.



Collage concealed frame is a sound absorbing notice board. It improves the acoustics and is a practical tool at the same time.

## COLLAGE ECOSUND®

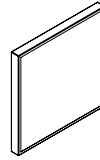

### Collage EcoSUND with frame in white, black, grey

			Acoustic Nonwoven	Hush	Blazer Lite
125700-	W. 600	H. 600	193,40	291,81	332,77
125701-	W. 1200	H. 600	216,06	318,40	375,96
125702-	W. 1200	H. 900	260,21	354,04	419,04
125703-	W. 1200	H. 1200	265,85	386,91	481,81
125704-	W. 1600	H. 1200	348,94	477,23	557,45
125705-	W. 2400	H. 1200	721,60	810,32	893,62

### Collage EcoSUND with frame in oak, walnut

				Hush	Blazer Lite
125730-	W. 1200	H. 1200		712,23	850,53
125731-	W. 1600	H. 1200		903,72	1010,11

See colour frame in the textile chapter.

### HOW TO ORDER COLLAGE

Art.No - Colour frame - Colour fabric/Acoustic Nonwoven.

Example: 125702-1-567= Collage with white frame in blue Hush.

### Mounting strip Dikt for frame

List for wall mount.

346000	320 mm (for print/absorbent 600 mm)	12.13
349000	620 mm (for print/absorbent 900 mm)	13.09
341200	920 mm (for print/absorbent 1200 mm)	14.04
341600	1320 mm (for print/absorbent 1600 mm)	17.87
342400	2120 mm (for print/absorbent 2400 mm)	26.49

Facts: Can only be ordered in textiles Acoustic Nonwoven, Hush and Blazer Lite. Also possible to dress in other textiles upon request. See textile chapter.

For orders of W. 2400 mm, minimum quantity: 5 pcs.

## COLLAGE ECOSUND® CONCEALED FRAME

### Collage concealed frame

			Hush	Blazer Lite
125706-	W. 600	H. 600	339,68	360,00
125707-	W. 1200	H. 600	371,06	390,85
125708-	W. 1200	H. 900	411,81	458,62
125709-	W. 1200	H. 1200	547,34	607,77
125710-	W. 1600	H. 1200	684,89	730,64
125711-	W. 2400	H. 1200	816,60	901,49

### HOW TO ORDER COLLAGE CONCEALED FRAME

Art.no - Textile.

Example: 125708-567 = Collage with concealed frame dressed with blue Hush.

Facts: Can be ordered in textiles Hush and Blazer Lite. Also possible to dress in other textiles upon request. See textiles in the textile chapter. For orders of W. 2400 mm, minimum quantity: 5 pcs.

### Mounting strip Dikt for frame

List for wall mount.

346000	320 mm (for print/absorbent 600 mm)	12.13
349000	620 mm (for print/absorbent 900 mm)	13.09
341200	920 mm (for print/absorbent 1200 mm)	14.04
341600	1320 mm (for print/absorbent 1600 mm)	17.87
342400	2120 mm (for print/absorbent 2400 mm)	26.49





## CEILING

A good sound environment has a direct connection to our wellbeing. We have sound absorbents that are designed to be mounted on the wall and ceiling and to suit all types of environments. Our absorbents are made of EcoSUND, a unique sound absorbing core material produced together with acousticians for optimal sound absorption. EcoSUND is available in several colours and our products can be chosen in their raw material, be dressed with textile, printed, cut into different shapes and customised to suit your needs.

## ROOM DIVIDERS

Several of our ceiling mounted absorbents also work as excellent room dividers.

They can be mounted on rails or directly in the grid to create rooms within the room, absorb sound and at the same time improve the decor with their colour and shape. Create zones where you combine the softer sound with the visual effect.

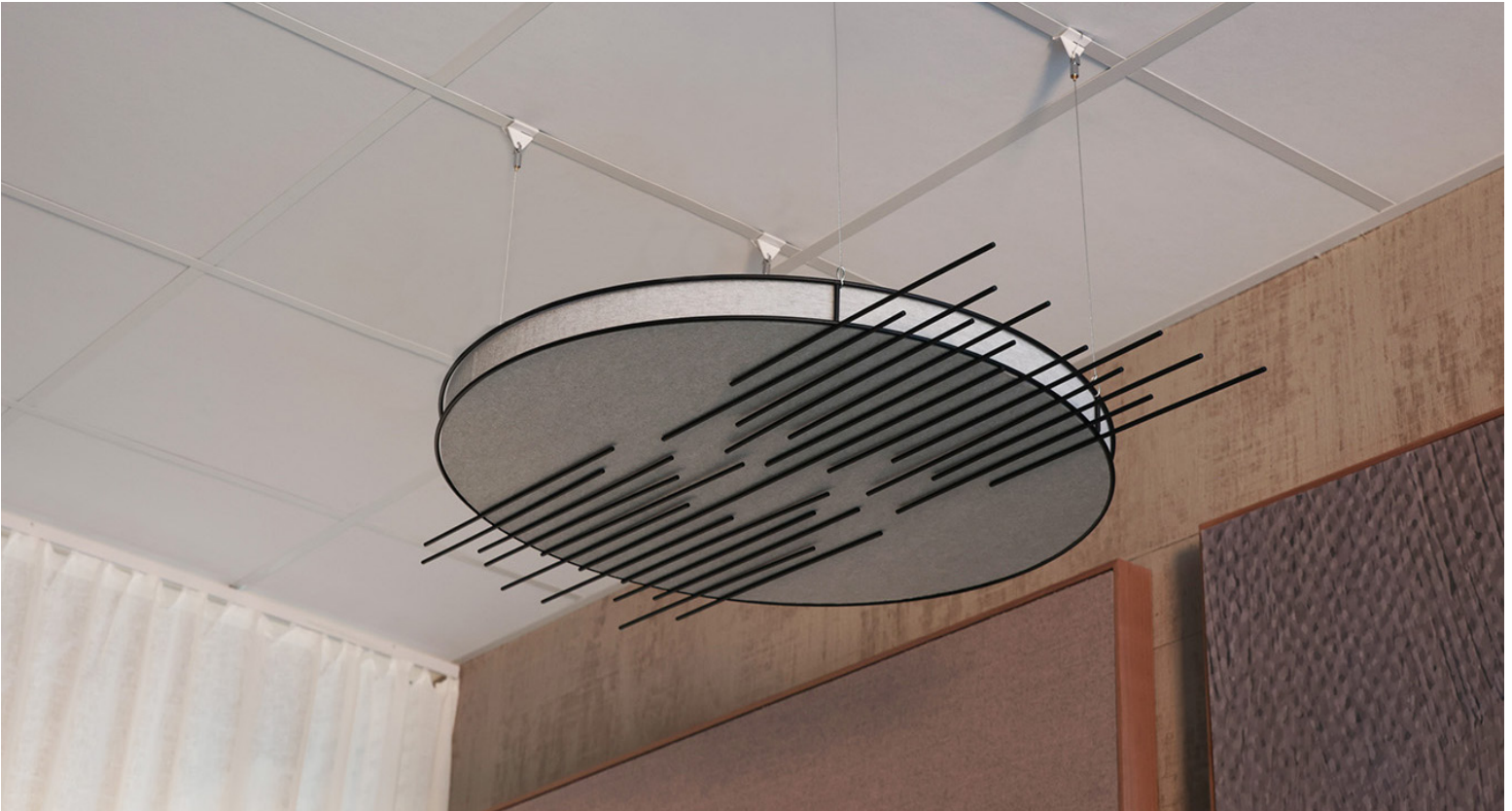

## LINK CEILING

Link is designed to function as a standalone design and create new patterns the more you have on the ceiling or wall. The straight wires create a contrast to the round shapes, and through the wires, a completely new expression is achieved. By placing them straight, a linear design is created. By varying the wire direction, the design becomes more abstract. The design of the wires is inspired by the sound waves they are meant to absorb..



### Link ceiling

Wire grid with wires for ceiling suspension or clips for ceiling/wall. With space for Off the Grid absorbent. 4 cables of 2 meters are included. Inner dimension depth 52 mm. Material: 5 mm steel wire.

644107-2 Ø 800 W. 1100 D. 62 black 286,70

### Off The Grid absorbent EcoSUND circle

126124- Ø 750 D. 50 raw 109,04  
126125- Ø 750 D. 50 dressed 174,79

For Off the Grid circle: choose Off the Grid absorbent in white, black or grey raw material or dress in Hush. See textiles in the textile chapter.



### Mount for ceiling rail T24

When mounting in ceiling rail T24. See drawings at [www.gotessons.com](http://www.gotessons.com)  
For Off the grid circle you need 1 mount.

642041-1 white -2 black 13.09/pc



### Mount for ceiling rail T15

When mounting in ceiling rail T15. See drawings at [www.gotessons.com](http://www.gotessons.com)

642048-1white -2 black 3-grey 11.17/pc

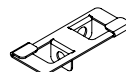

### Adjustable mount T24

Contains: 2 brackets.

Adjustable, means that you can fold down two different tinplates to swing down products in two different directions. Can not be hung directly on EcoSUND.

642044-1 white 2 black -3 silver 7.13

Clamp design is also possible to mount on the wall, please see wall chapter.

Important info: Can be mounted in any ceiling. Mounts 642041 or 642044 are needed for mounting in acoustic ceiling, are not included.



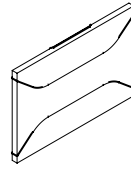

### Clamp Design

Brackets are mounted on the ceiling or on the wall.

Fits Effekt with width 1200 mm.

Material: powder coated metal. 2 brackets included, screw not included.

The clamps builds 260 mm into the absorber.

644108-1	W. 1200	H. 200	D. 62	white	84,57
644108-2	W. 1200	H. 200	D. 62	black	84,57
644108-21	W. 1200	H. 200	D. 62	greengrey	84,57

### Effekt EcoSUND ceiling/wall

125130-	W. 1200	H. 600	D. 50	raw	88,30
125131-	W. 1200	H. 600	D. 50	dressed	153,19
125132-	W. 1200	H. 900	D. 50	raw	131,60
125133-	W. 1200	H. 900	D. 50	dressed	191,28
125135-	W. 1200	H. 1200	D. 50	raw	180,85
125134-	W. 1200	H. 1200	D. 50	dressed	244,68

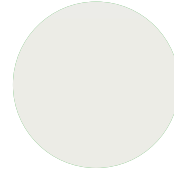

Colour: -1 white  
(RAL 9003, GL 30)

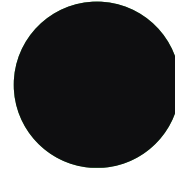

Colour: -2 black  
(RAL 9005, GL 30)

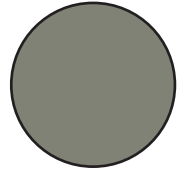

Colour: -21 greengrey  
(RAL 7033, GL 30)

## CLAMP DESIGN

Clamp design consists of two metal brackets that are attached to the ceiling or wall and then combined with the EcoSUND effect. Clamp becomes a discreet and stylish suspension for sound absorbers where the focus is on highlighting the material to achieve maximum sound absorption.



Clamp design is also possible to mount on the wall, please see wall chapter.



Fix the acoustics with smart sound absorbent Effekt EcoSUND Ceiling/Wall with clamps. For a discrete sound absorbing system in the ceiling or on the wall, two clamps per panel is mounted, the panel is slid inside the clamps and improves the sound environment immediately. Choose Effekt Ceiling/Wall in raw EcoSUND in colour white, black, grey or bronze brown. To match the rest of your interior, dress the panels in textile Hush.



## EFFEKT ECOSUND® CEILING/WALL

### Effekt EcoSUND ceiling/wall

125130-	W. 1200	H. 600	D. 50	raw	88,30
125131-	W. 1200	H. 600	D. 50	dressed	153,19
125132-	W. 1200	H. 900	D. 50	raw	131,60
125133-	W. 1200	H. 900	D. 50	dressed	191,28

### ORDER EFFEKT CEILING/WALL RAW:

Art.no - core material

Example: 125130-2 = Effekt EcoSUND in black

### ORDER EFFEKT CEILING/WALL DRESSED IN HUSH

Art.no - Colour of textile - Colour of edge (core material/raw)

Example: 125131-567-1 = Effekt EcoSUND dressed in blue Hush and white edge (core material/raw)

Each panel is mounted with 2 clamps (not included). Dressed Effekt can only be ordered in textile Hush.

See page 6-14 for textile and core material.

Colour code core material: white-1 black-2 grey-3 light grey-6

### Clamp 600 mm for Effekt EcoSUND ceiling/wall

Low clamp lies tight against the Effekt Ceiling/Wall EcoSUND.

W. 600 H. 56 D. 30

643090-1 white -2 black -3 silver 19.04/2pcs

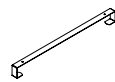

### Clamp 900 mm for Effekt EcoSUND ceiling/wall

Low clamp lies tight against the Effekt Ceiling/Wall EcoSUND.

W. 900 H. 56 D. 30

643091-1 white -2 black -3 silver 27.77/2pcs

### Clamp air gap 600 mm for Effekt EcoSUND ceiling/wall

High clamp for 50 mm air gap behind the absorbent.

W. 600 H. 107 D. 30

643092-1 white -2 black -3 silver 26.49/2pcs

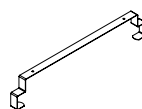

### Clamp air gap 900 mm for Effekt EcoSUND ceiling/wall

High clamp for 50 mm air gap behind the absorbent.

W. 900 H. 107 D. 30

643093-1 white -2 black -3 silver 30.11/2pcs



## TILES TRACKS STRAIGHT

Create unique patterns on the ceiling with Tiles Tracks Straight or Curve. The top layer is covered in a brown textile, the raw material is anthracite grey. Easily installed in T24 supports. Feel free to combine with the AddOn Ceiling system for an even more personal expression in the ceiling.

### Tiles Tracks straight

Material: Pressed polyester fiber. Mounted directly in T-24 grids.  
Contents: 4 absorbers.

121450-10 W. 593 H. 593 D. 25  
121450-11 W. 593 H. 593 D. 25

light grey  
grey/brown\*

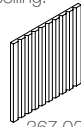

367.02  
452.13

\*The top layer is laminated with textile *Texfel*®.



## TILES TRACKS CURVE

Tiles Tracks curve has softer shapes than the straight variant. Combine both variants to get an inviting pattern on the ceiling.

### Tiles Tracks Curve

Material: Pressed polyester fiber. Mounted directly in T-24 grids.  
Contents: 4 absorbers.

121455-11 W. 593 H. 593 D. 25

grey/brown\* 452.13



\*The top layer is laminated with textile *Texfel*®.





## ADDON CEILING

AddOn Ceiling is a profile system for T-24 trusses. With a few clicks, the anonymous suspended ceiling turns into an interior detail that lifts the entire room. The system works with all visible T-24 supports, both new and old, and can be easily combined with Tiles EcoSund or Tiles Nova for uniform color. There are six muted colors as standard. For special colors, request a quote. Designed by o4i Designstudio.



## ADDON CEILING

*Powder coated metal. The profile system consists of cross profiles and ceiling profiles that are mounted on an existing T24 support structure. The metal profile is clicked onto the supporting structure. See assembly instructions at [www.gotessons.se](http://www.gotessons.se).*

### AddOn Ceiling 600

*Contains: 1 pc.*

644155-      W. 26    L. 560    H. 8      8.51

### AddOn Ceiling 1200

*Contains: 1 pc.*

644156-      W. 26    L. 1160    H. 8      17.02

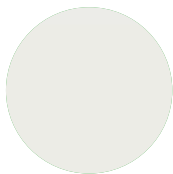

Colour: -1 white  
(RAL 9003, GL 30)

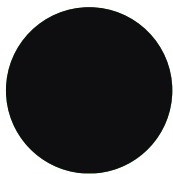

Colour: -2 black  
(RAL 9005, GL 30)

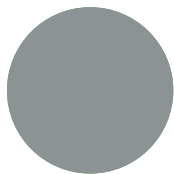

Colour: -5 grey  
(RAL 7045, GL 30)

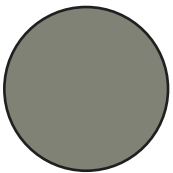

Colour: -21 green grey  
(RAL 7033, GL 30)

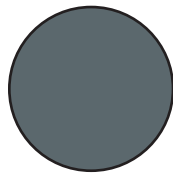

Colour: -22 blue grey  
(RAL 7031, GL 30)

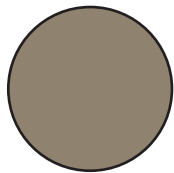

Colour: -23 pearl beige  
(RAL 1035, GL 30)

AddOn can also be obtained in other RAL on quotation.

Example wall-to-wall (with external corner)

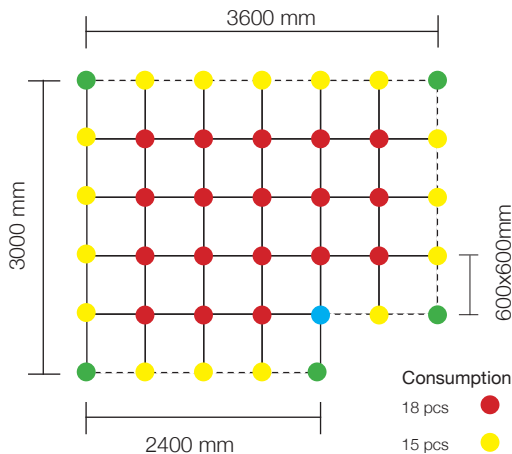

Consumption for this example

- 18 pcs ● Cross - 644157
- 15 pcs ● T-Cross - 644158
- 15 pcs ● Corner - 644159
- 1 pc ● Outer Corner - 644160
- 45 pcs — AddOn Ceiling 600 mm
- 13,2 m ..... AddOn Ceiling tape

## ADDON CEILING

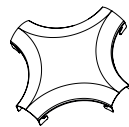

● AddOn Ceiling Cross

Contains: 1 pc.

644157- W. 125 L. 125 H. 10

10.64

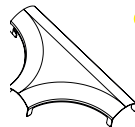

● AddOn Ceiling T-Cross

Contains: 1 pc.

644158- W. 76 L. 125 H. 10

10.64

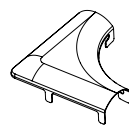

● AddOn Ceiling Corner

Contains: 1 pc.

644159- W. 76 L. 76 H. 10

10.64

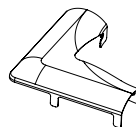

● AddOn Ceiling Outer Corner

Contains: 1 pc.

644160- W. 76 L. 76 H. 10

10.64

AddOn Ceiling tape

Tape to apply to e.g. wall molding when AddOn cannot be mounted all the way to the wall.

644165-1 W. 30 mm L. 50 m

148.40

When ordering, you can calculate how many cross and roof profiles are needed. See suggestions. Contact [info@gotessons.se](mailto:info@gotessons.se) for more information. Choose article number - choose color - choose quantity.  
Eg 644155-21 = AddOn Ceiling 600-green.



Improve the sound environment with Tiles Nova EcoSUND dressed in stylish textile Nova. Choose between six different colour combinations: we have chosen three unique colours for white EcoSUND and three unique colours for black EcoSUND for a harmonic result. Create patterns on the often forgotten area above your head with a 6-pack Tiles and easily continue with more packs or solo Tiles.



## TILES NOVA ECOSUND®

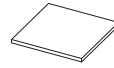

### Tiles Nova EcoSUND

*Nova 4945 on white EcoSUND*

126802-773-1 W. 593 L. 593 D. 50 dressed 60.53

*Nova 4844 on white EcoSUND*

126802-774-1 W. 593 L. 593 D. 50 dressed 60.53

*Nova 6650 on white EcoSUND*

126802-775-1 W. 593 L. 593 D. 50 dressed 60.53

*Nova 6252 on white EcoSUND*

126802-776-1 W. 593 L. 593 D. 50 dressed 60.53

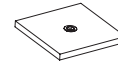

### Tiles Nova EcoSUND with lamp

*Nova 4945 on white EcoSUND*

126805-773-1 W. 593 L. 593 D. 50 dressed 253.19

*Nova 4844 on white EcoSUND*

126805-774-1 W. 593 L. 593 D. 50 dressed 253.19

*Nova 6650 on white EcoSUND*

126805-775-1 W. 593 L. 593 D. 50 dressed 253.19

*Nova 6252 on white EcoSUND*

126805-776-1 W. 593 L. 593 D. 50 dressed 253.19

Mounting: see drawings on [www.gotessons.com](http://www.gotessons.com).  
Dimmable LED, are installed by an electrician.

### Tiles Nova EcoSUND 6 pcs

*Nova 4945 on white EcoSUND 6 pcs*

121222-773-1 W. 593 L. 593 D. 50 dressed 303.19/set

*Nova 4844 on white EcoSUND 6 pcs*

121222-774-1 W. 593 L. 593 D. 50 dressed 303.19/set

*Nova 6650 on white EcoSUND 6 pcs*

121222-775-1 W. 593 L. 593 D. 50 dressed 303.19/set

*Nova 6252 on white EcoSUND 6 pcs*

121222-776-1 W. 593 L. 593 D. 50 dressed 303.19/set

Can only be used in grids or together with In The Grid.  
Colour combinations are predetermined for this product.  
Textile Nova can only be used with this product.

## NOVA BY SVENSSON



Colour 773  
(4945)

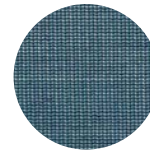

Colour 774  
(4844)



Colour 775  
(6650)

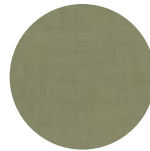

Colour 776  
(6252)

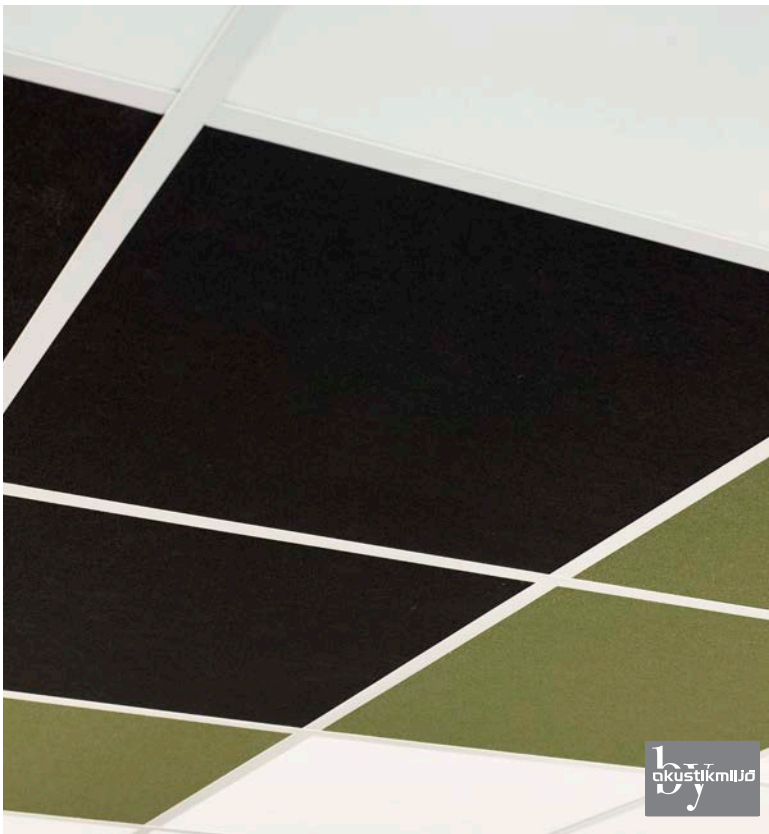

## TILES ECOSUND® RAW / DRESSED

### Tiles raw EcoSUND / Tiles dressed EcoSUND

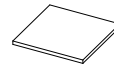

126800-	W. 593	L. 593	D. 50	raw	39,79
126801-	W. 593	L. 593	D. 50	dressed	55,00

### Tiles raw EcoSUND with lamp / Tiles dressed EcoSUND with lamp

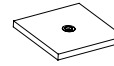

126803-	W. 593	L. 593	D. 50	raw	181,70
126804-	W. 593	L. 593	D. 50	dressed	233,09

### Tiles raw EcoSUND 6-pack / Tiles Dressed EcoSUND 6-pack

121220-	W. 593	L. 593	D. 50	raw	200,64/set
121221-	W. 593	L. 593	D. 50	dressed	276,28/set

Colour code core material: white-1 black-2 grey-3 light grey-6

Add a personal touch to the ceiling with Tiles EcoSUND. EcoSUND is a unique core material made of 50% recycled polyester which dampens sound that bounces in a room. Tiles are available in raw EcoSUND in colours - white, black, grey or bronze brown, or dressed in textile Hush/Acoustic Nonwoven. Create patterns on the often forgotten area above your head with a 6-pack Tiles and easily continue with more packs or solo Tiles. Choose Tiles with a combined lamp for a smart 2-in-1 solution of acoustics and lighting.



## TILES ACOUSTIC NONWOVEN ECOSUND®

### Tiles Acoustic Nonwoven EcoSUND

126808-901	W. 593	L. 50	D. 593	white	43.40
126808-902	W. 593	L. 50	D. 593	black	43.40

### Tiles Acoustic Nonwoven EcoSUND with lamp

126809-901	W. 593	L. 50	D. 593	white	193.30
126809-902	W. 593	L. 50	D. 593	black	193.30

### Tiles Acoustic Nonwoven EcoSUND 6 pcs

121225-901	W. 593	L. 50	D. 593	white	225.53/set
121225-902	W. 593	L. 50	D. 593	black	225.53/set

Important info: Can only be ordered raw or dressed in Hush/Acoustic Nonwoven, see colours and core material on page 10+16.  
Mounting: see drawings on [www.gotessons.com](http://www.gotessons.com).  
Dimmable LED, are installed by an electrician.

### ORDER TILES RAW ECOSUND

Order Tiles Raw EcoSUND (1-piece or 6-pack):

Art.no - Core material Example: 126800 - 1 = Tiles Raw EcoSUND in white

### ORDER TILES ECOSUND DRESSED IN HUSH (1-piece or 6-pack)

Art.no - Colour of textile - Colour of edge (core material/raw)

Example: 126800 - 567 - 1 = Tiles Dressed EcoSUND in blue Hush and white edge (core material/raw).

Colour code core material: white-1

Tiles with acoustic nonwoven fabric EcoSUND are sound absorbers for grids that add a personal touch to the ceiling. Made of the sound absorbing core material EcoSUND and covered with acoustic nonwoven.

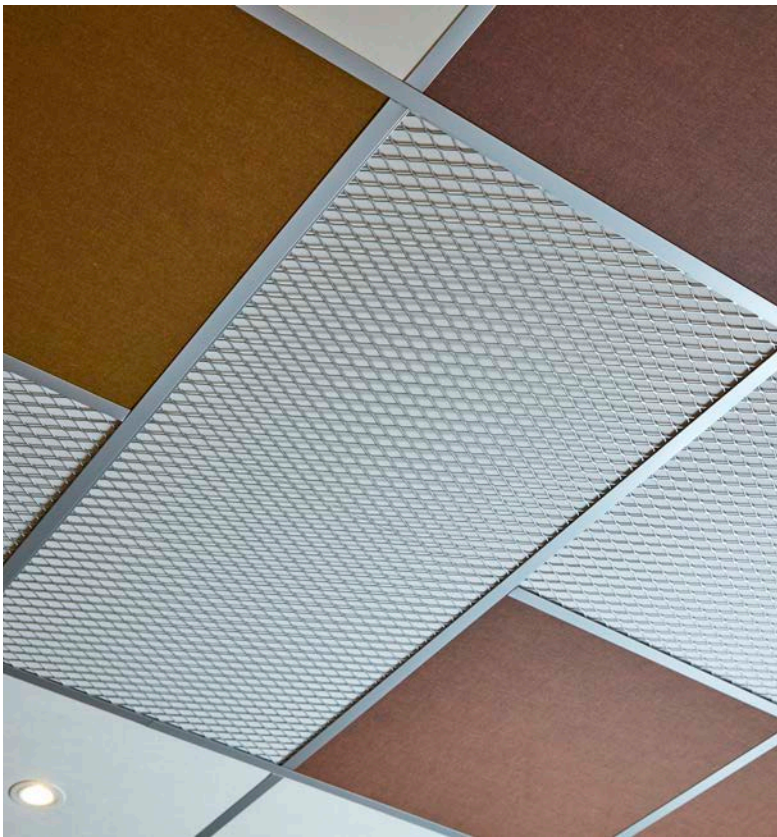

## IN THE GRID

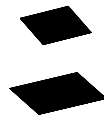

### IN THE GRID

Available in two sizes and in colours silver and brass. Combine with Tiles.

644010-3	W. 595	L. 595	D. 4	silver	82.87
644010-20	W. 595	L. 595	D. 4	brass	84.26
644020-3	W. 1195	L. 595	D. 4	silver	130.53
644020-20	W. 1195	L. 595	D. 4	brass	133.19

---

Important info: Mounted straight in a T-24 grid.

---

In The Grid is a decorative wire frame in silver or brass, mounted straight into the ceiling grid, adding a luxurious touch to the room. Available in two sizes and can be combined with one or two Tiles for sound absorption. To match the rest of the interior, Tiles in all its variations can be used in In The Grid: Tiles Nova EcoSUND, Tiles dressed in Hush or Tiles in raw EcoSUND.



## IN THE GRID NATURE



### In The Grid nature

Mounted directly in T-24 grids. Can not be combined with Tiles with lamp.

644070-20	W. 595	L. 595	D. 10	brass	119.79
644070-3	W. 595	L. 595	D. 10	silver	112.98

In The Grid nature är another version of the popular decorative metal grid that is mounted directly in the ceiling grid. It can be combined with already existing ceiling panels or with Götessons Tiles for good sound absorption: Nova, raw or dressed. Create a fun pattern on the ceiling or build zones over work stations - the possibilities are many!





Vertikal is an acoustic lamella blind, perfect for most types of spaces and is perfect to absorb sound that bounces against hard surfaces and large glass areas.

## VERTIKAL ECOSUND®

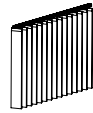

### Vertikal EcoSUND

The lamellas are made of our unique sound absorbing core material EcoSUND in white, grey or black. Standard lamella width is 127 mm and height 3000 mm and maximum rail length is 3000 mm. Vertikal is easily adjusted in different positions and can be pushed aside if you wish and is therefore suitable wherever you wish to regulate reverberation. The absorber can be dressed on one or two sides.

121240-

Contact us for price

### ORDER VERTIKAL

1. Specify length of the rail
2. Specify whether the blinds should be pulled to the left, right, or parted in the middle
3. Choose the position of the strings right / left. Distance string-floor 1500 mm
4. Select the type of mounts (standard, T-24, distance or wall mounted)
5. Enter the desired overall height (mm) from the top edge of the rail to the bottom edge of the lamella
6. Choose colour of the core material
7. Choose fabric for the front
8. Specify fabric or warmed surface for the back. For other measurements, please contact us.

Important info: when light textile is chosen against dark core material, the dark shines through. The edge will be raw.

Colour code core material: white-1 black-2 grey-3 light grey-6

MOUNTS	Distance to ceiling mounts.
Additional brackets for T-24 ceiling grids	Wall mounts Standard ceiling mounts

Mounting: Attach the rail that is delivered with the blinds and mount the lamella blinds. The rail can be mounted onto the wall or ceiling with the mounts you have chosen. At the bottom of the blinds a chain is fitted between the weights.



Lod is an acoustic lamina bar made of our unique core material EcoSUND in white, grey or black that is visible on the sides. The bars are always laminated on the front and back - choose from the colours from Opaq on this page. Because Lod is hung, it can replace curtains or be used as a room divider.

## LOD ECOSUND®

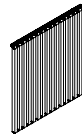

### Lod EcoSUND

The Lod bars are 50x50 mm with an air gap of 40 mm. The rail is W: 45 mm and H: 25 mm. Maximum rail length is 3000 mm. Maximum bar length: 3000 mm. Lod is always bespoke to suit your environment's needs and is adjusted after the rail and bars' length.

121230-

Contact us for price

### ORDER LOD

1. Specify length of the rail in mm
2. Select the type of mounts (standard, T-24, distance or wall mounted)
3. Enter the desired overall height from the top edge of the rail to the bottom of the bars
4. Select colour of core material
5. Select fabric for the front
6. Select fabric for the back.

Important info: when light textile is chosen against dark core material, the dark shines through. The edge will be raw.

Colour code core material: white-1 black-2 grey-3 light grey-6

MOUNTS	Distance to ceiling mounts.
Additional brackets for T-24 ceiling grids	Wall mounts Standard ceiling mounts

Mounting: Mount the rail to the ceiling or wall with the selected mounts. The bars are then hung in the hangers on the rail's bottom. At the bottom of the bars, attach the stabilising plate to the bottom of the bars.

## OPAQ BY SVENSSON

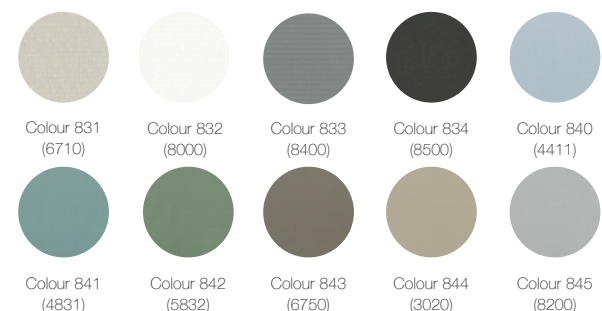



Room divider Divido in molded felt creates life and screens open spaces. Consists of two panels that together form a neat pattern.



## DIVIDO

Two vertically hanging panels á 800 mm/each. Made of molded felt from at least 55 % recycled PET. Fitting bag is purchased separately.

### Divido Birch

121300-1	W. 1600	H. 2350	D. 8	gravel	459.68
121300-2	W. 1600	H. 2350	D. 8	slate	459.68
121300-8	W. 1600	H. 2350	D. 8	ivory	459.68
121305-1	W. 1600	H. 2450	D. 8	gravel	470.64
121305-2	W. 1600	H. 2450	D. 8	slate	470.64
121305-8	W. 1600	H. 2450	D. 8	ivory	470.64
121310-1	W. 1600	H. 2650	D. 8	gravel	481.60
121310-2	W. 1600	H. 2650	D. 8	slate	481.60
121310-8	W. 1600	H. 2650	D. 8	ivory	481.60

### Divido Tree

121315-1	W. 1600	H. 2350	D. 8	gravel	459.68
121315-2	W. 1600	H. 2350	D. 8	slate	459.68
121315-8	W. 1600	H. 2350	D. 8	ivory	459.68
121320-1	W. 1600	H. 2450	D. 8	gravel	470.64
121320-2	W. 1600	H. 2450	D. 8	slate	470.64
121320-8	W. 1600	H. 2450	D. 8	ivory	470.64
121325-1	W. 1600	H. 2650	D. 8	gravel	481.60
121325-2	W. 1600	H. 2650	D. 8	slate	481.60
121325-8	W. 1600	H. 2650	D. 8	ivory	481.60

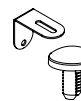

### Divido attachment bag ceiling bracket

Contains: 6 pcs of ceiling mount, 6 pcs of clutch rivet.

121330-1	white	46.60
121330-2	black	46.60



### Divido attachment bag ceiling bracket T24

Included: 6 pcs of ceiling mount for T24, 6 pcs of clutch rivet.

121331-1	white	87,13
121331-2	black	87,13



### Wire

Wire suspension. 2 m, adjustable. Consumption to Divido, 6 pcs.

20572	14,36/pc
-------	----------



## DIVIDO

Two vertically hanging panels á 800 mm/each. Made of molded felt from at least 55 % recycled PET. Fitting bag is purchased separately.



### Divido Circles

121515-1	W. 1600	H. 2350	D. 8	gravel	459.68
121515-2	W. 1600	H. 2350	D. 8	slate	459.68
121515-8	W. 1600	H. 2350	D. 8	ivory	459.68
121520-1	W. 1600	H. 2450	D. 8	gravel	470.64
121520-2	W. 1600	H. 2450	D. 8	slate	470.64
121520-8	W. 1600	H. 2450	D. 8	ivory	470.64
121525-1	W. 1600	H. 2650	D. 8	gravel	481.60
121525-2	W. 1600	H. 2650	D. 8	slate	481.60
121525-8	W. 1600	H. 2650	D. 8	ivory	481.60



### Divido Leaves

121530-1	W. 1600	H. 2350	D. 8	gravel	459.68
121530-2	W. 1600	H. 2350	D. 8	slate	459.68
121530-8	W. 1600	H. 2350	D. 8	ivory	459.68
121535-1	W. 1600	H. 2450	D. 8	gravel	470.64
121535-2	W. 1600	H. 2450	D. 8	slate	470.64
121535-8	W. 1600	H. 2450	D. 8	ivory	470.64
121540-1	W. 1600	H. 2650	D. 8	gravel	481.60
121540-2	W. 1600	H. 2650	D. 8	slate	481.60
121540-8	W. 1600	H. 2650	D. 8	ivory	481.60

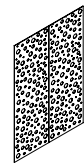

### Divido Bubbles

121500-1	W. 1600	H. 2350	D. 8	gravel	459.68
121500-2	W. 1600	H. 2350	D. 8	slate	459.68
121500-8	W. 1600	H. 2350	D. 8	ivory	459.68
121505-1	W. 1600	H. 2450	D. 8	gravel	470.64
121505-2	W. 1600	H. 2450	D. 8	slate	470.64
121505-8	W. 1600	H. 2450	D. 8	ivory	470.64
121510-1	W. 1600	H. 2650	D. 8	gravel	481.60
121510-2	W. 1600	H. 2650	D. 8	slate	481.60
121510-8	W. 1600	H. 2650	D. 8	ivory	481.60



### Divido attachment bag ceiling bracket

Contains: 6 pcs of ceiling mount, 6 pcs of clutch rivet.

121330-1	white	46.60
121330-2	black	46.60



### Divido attachment bag ceiling bracket T24

Included: 6 pcs of ceiling mount for T24, 6 pcs of clutch rivet.

121331-1	white	87,13
121331-2	black	87,13



### Wire

Wire suspension. 2 m, adjustable. Consumption to Divido, 6 pcs.

20572	14,36/pc
-------	----------



gravel



slate



ivory



Hanging from the ceiling, Pendula becomes an effective room divider that improves the acoustics in the room while also becoming a stylish interior detail. Design Henrik Kjellberg and Jon Lindström, o4i Design Studio.



#### HOW TO ORDER PENDULA CLOUD/PIXEL/WAVE RAW

1. Art.No - Colour core/raw. Example: 121400-2 = Pendula EcoSUND 800x400x50 with black core/raw.

#### HOW TO ORDER PENDULA CLOUD/PIXEL/WAVE WITH HUSH

1. Art.No - Colour textile - Edge colour (core/raw).  
Example: 121401-567-1 = Pendula EcoSUND 800x400x50 with blue Hush and white edge (core/raw).

- Order ceiling package. Choose T24 or Ceiling package angle mount.  
Consumption 1 package/Cloud/Wave, 2 packages/Pixel.
- Order wire (if the product is to be mounted with wire).  
Consumption 1 package/Cloud/Wave, 2 package/Pixel.
- Order distance packages, observe the correct number. See information for each product.



## PENDULA ECOSUND®

### Pendula Cloud

Contents: 5 absorbers. Total height: 2370 mm. Mounts/Distances not included.

121400-	W. 2400	H. 400	D. 50	raw	936,28
121401-	W. 2400	H. 400	D. 50	dressed	1533,51

Colour code core material: white-1 black-2 grey-3 light grey-6

Consumption of distance packages 644002: The product can be mounted with a distance package directly in the ceiling bracket instead of a wire. It is recommended that there are several people during assembly.

Cloud: 4 packages for wire suspension, 5 packages for remote suspension.

Consumption of ceiling packages 644004/644005: 1 package.

Consumption of wire 644006: 1 package.

See below for distance packages.

See next page for ceiling mounts.

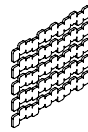

### Pendula Pixel

Contents: 5 absorbers. Total height: 2170 mm. Mounts/Distances not included.

121410-	W. 2400	H. 400	D. 50	raw	936,28
121411-	W. 2400	H. 400	D. 50	dressed	1533,51

Colour code core material: white-1 black-2 grey-3 light grey-6

Consumption of distance packages 644002: The product can be mounted with a distance package directly in the ceiling bracket instead of a wire. It is recommended that there are several people during assembly.

Pixel : 6 packages for wire suspension, 8 packages for remote suspension.

Consumption of ceiling packages 644004/644005: 2 package.

Consumption of wire 644006: 2 package.

See below for distance packages.

See next page for ceiling mounts.



### Pendula Wave

Contents: 4 absorbers. Total height: 1600 mm. Mounts/Distances not included.

121420-	W. 2400	H. 343	D. 50	raw	607,55
121421-	W. 2400	H. 343	D. 50	dressed	854,15

Colour code core material: white-1 black-2 grey-3 light grey-6

Consumption of distance packages 644002: The product can be mounted with a distance package directly in the ceiling bracket instead of a wire. It is recommended that there are several people during assembly.

Wave : 3 packages for wire suspension, 4 packages for remote suspension.

Consumption of ceiling packages 644004/644005: 1 package.

Consumption of wire 644006: 1 package.

See below for distance packages.

See next page for ceiling mounts.

## DISTANCE PACKAGE PENDULA

### Distance package

Contains: 2 hangers and 4 metal pins. The sprint goes through holes in the EcoSUND plate. The distance is mounted between two Pendulas. Space between absorbers will be 145 mm.

644002-1	white	-2 black	-3 grey	15.85
----------	-------	----------	---------	-------



Pendula is an updated version of Effekt Pendent. The panels come in two widths and are made in our sound absorbing core material EcoSUND. Can be mounted solitaire on the ceiling or built vertically as a room divider. An effective way to improve acoustics in a room without changing existing installations such as ventilation, cables, lamps etc. The product needs to be mounted with the Pendula distance package and with an optional ceiling bracket, which is ordered separately. Design Henrik Kjellberg and Jon Lindström, o4i Design Studio.

## PENDULA ECOSUND®

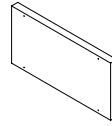

### Pendula Square

125140-	W. 800	H. 400	D. 50	raw	29,04
125141-	W. 800	H. 400	D. 50	dressed	59,68
125142-	W. 800	H. 600	D. 50	raw	43,30
125143-	W. 800	H. 600	D. 50	dressed	95,85
125144-	W. 800	H. 800	D. 50	raw	61,91
125145-	W. 800	H. 800	D. 50	dressed	127,66
125146-	W. 800	H. 1200	D. 50	raw	87,13
125147-	W. 800	H. 1200	D. 50	dressed	195,64
125156-	W. 1600	H. 400	D. 50	raw	58,62
125157-	W. 1600	H. 400	D. 50	dressed	130,96
125158-	W. 1600	H. 600	D. 50	raw	90,43
125159-	W. 1600	H. 600	D. 50	dressed	195,64
125160-	W. 1600	H. 800	D. 50	raw	116,70
125161-	W. 1600	H. 800	D. 50	dressed	259,15
125162-	W. 1600	H. 1200	D. 50	raw	178,09
125163-	W. 1600	H. 1200	D. 50	dressed	390,64

Colour code core material: white-1 black-2 grey-3 light grey-6

The product needs to be mounted with the distance package Pendula and with an optional ceiling bracket, this is purchased separately. Large sizes of Pendula may require two people for assembly.

### Pendula distance package

Contains: 2 hangers and 4 pins in metal.

The sprint goes through holes in the EcoSUND plate, the spacer is mounted in any ceiling bracket or between two Pendulas.

644001 - distance between absorbers 100 mm

644003 - distance between absorbers 400 mm

644001-1	L. 146	white	10.43
644001-2	L. 146	black	10.43
644001-3	L. 146	grey	10.43
644003-1	L. 446	white	24.68
644003-2	L. 446	black	24.68
644003-3	L. 446	grey	24.68

### HOW TO ORDER PENDULA SQUARE RAW

Art.No - Colour core/raw. Example: 125140-2 = Pendula EcoSUND 800x400x50 with black core/raw.

### HOW TO ORDER PENDULA SQUARE WITH HUSH

1.Art.No - Colour textile - Edge colour (core/raw). Example: 125141-567-1 = Pendula EcoSUND 800x400x50 with blue Hush and white edge (core/raw).

2. Order ceiling bracket and distance package.

## CEILING MOUNT PENDULA

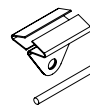

### Ceiling kit T24

Contains: 2 pcs T24 clips, 2 pcs pins.

The sprint goes through holes in the EcoSUND plate.

644004-1	white -2 black -3 grey	26.17
----------	------------------------	-------

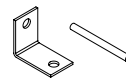

### Ceiling kit angle mount

Contains: 2 angle brackets, 2 pins. For other ceilings than T24.

644005-1	white -2 black -3 grey	15.85
----------	------------------------	-------



### Wire kit

Contains: 2 wires, 2 pins

Wire to suspend absorbent from the ceiling. 2 meter, adjustable..

644006		34.47
--------	--	-------

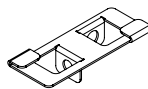

### Adjustable mount T24

Contains: 2 brackets.

Adjustable, means that you can fold down two different tinplates to swing down products in two different directions. Can not be hung directly on EcoSUND.

642044-1	white 2 black -3 silver	7.13
----------	-------------------------	------



## SKY ECOSUND®

Sky is a ceiling-mounted sound absorber that is manufactured in a thickness of 50 mm to create good sound absorption. It is made of our core material EcoSUND. Mounted with advantage in an open landscape office to effectively improve the acoustics and create a cosy feeling. Design Henrik Kjellberg and Jon Lindström, o4i Design Studio.



## SKY ECOSUND®

Mounted with associated fittings that inserts into the plate's fibres. The edge is always raw. Raw material in white, black, grey and light grey or dress with textile Hush, the same on both sides.

## SKY SHORELINE ECOSUND®

### Sky Shoreline

Contents: 4 absorbers.

129900-	W. 2400	H. 400	D. 50	raw	610,00
129901-	W. 2400	H. 400	D. 50	dressed	853,72

## SKY PIXEL ECOSUND®

### Sky Pixel

Contents: 5 st absorbers.

121412-	W. 2400	H. 400	D. 50	raw	936,28
121413-	W. 2400	H. 400	D. 50	dressed	1533,51

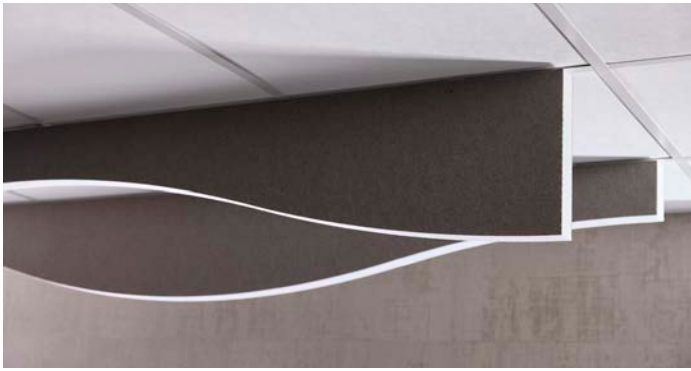

## SKY DUNE ECOSUND®

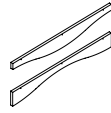

### Sky Dune

Contents: 6 st absorbers, 3x2 different shapes.

121432-	W. 2400	H. 280	D. 50	raw	607,55
121433-	W. 2400	H. 280	D. 50	dressed	854,15



## SKY CLOUD ECOSUND®



### Sky Cloud

Contents: 5 st absorbers.

121402-	W. 2400	H. 400	D. 50	raw	936,28
121403-	W. 2400	H. 400	D. 50	dressed	1533,51



## SKY WAVE ECOSUND®



### Sky Wave

Contents: 4 absorbers.

121422-	W. 2400	H. 343	D. 50	raw	607,55
121423-	W. 2400	H. 343	D. 50	dressed	854,15

### HOW TO ORDER SKY ECOSUND RAW

Art.No - Colour core. Example: 129900-2 = Sky Shoreline with black core.

### HOW TO ORDER SKY ECOSUND WITH HUSH

Art.No - Colour textile - Edge colour (core).

Example: 129901-567-1 = Sky Shoreline with blue Hush and white edge (core).

2. Order mounting kit. Choose T24 or ceiling package angle bracket.

Consumption 1 package/product.

Colour code core material: white-1 black-2 grey-3 light grey-6

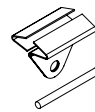

### Ceiling kit T24

Contains: 2 pcs T24 clips, 2 pcs pins.

The sprint goes through holes in the EcoSUND plate.

644004-1	white	-2 black	-3 grey	26.17
----------	-------	----------	---------	-------

Number of ceiling package:

Dune: 9 package

Pixel: 8 package

Cloud: 5 package

Wave: 4 package

Shoreline: 6 package

We recommended that there are several people for mounting.

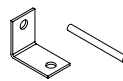

### Ceiling kit angle mount

Contains: 2 angle brackets, 2 pins. For other ceilings than T24.

644005-1	white	-2 black	-3 grey	15.85
----------	-------	----------	---------	-------

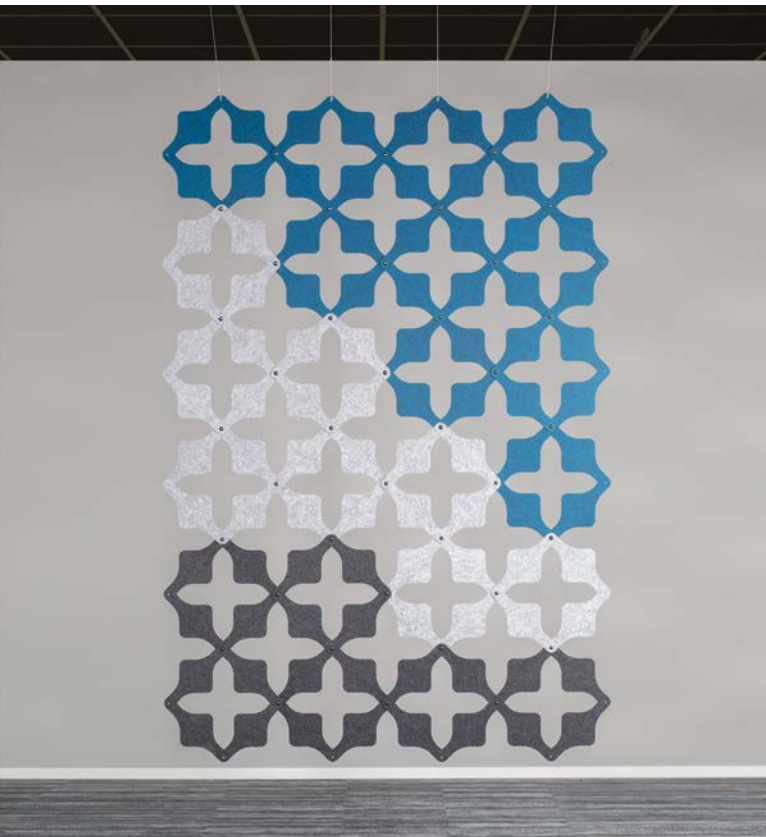

Create shielding between different workplaces and surfaces or a room in the room. Made from mould pressed felt, choose from several different colours.

## COBOGO



### Cobogo 12 pcs

12 pcs of vertical hanging panels for ceilings made of moulded felt, made of at least 55% recycled PET. Thickness: 5 mm.

121213-1	W. 372	H. 372	D. 5	gravel	253.09
121213-2	W. 372	H. 372	D. 5	slate	253.09
121213-3	W. 372	H. 372	D. 5	pine	253.09
121213-4	W. 372	H. 372	D. 5	moss	253.09
121213-5	W. 372	H. 372	D. 5	plum	253.09
121213-6	W. 372	H. 372	D. 5	cherry	253.09
121213-7	W. 372	H. 372	D. 5	cyan	253.09
121213-8	W. 372	H. 372	D. 5	ivory	253.09
121213-9	W. 372	H. 372	D. 5	hemp	253.09

### Cobogo 3 pcs

3 pcs of vertical hanging panels for ceilings made of moulded felt, made of at least 55% recycled PET. Thickness: 5 mm.

121214-1	W. 372	H. 372	D. 5	gravel	84.04
121214-2	W. 372	H. 372	D. 5	slate	84.04
121214-3	W. 372	H. 372	D. 5	pine	84.04
121214-4	W. 372	H. 372	D. 5	moss	84.04
121214-5	W. 372	H. 372	D. 5	plum	84.04
121214-6	W. 372	H. 372	D. 5	cherry	84.04
121214-7	W. 372	H. 372	D. 5	cyan	84.04
121214-8	W. 372	H. 372	D. 5	ivory	84.04
121214-9	W. 372	H. 372	D. 5	hemp	84.04

Mounting: Assemble the panels with the included black rivets.

For suspension in T24 supports: 642041, purchased separately.

For hanging from ceilings without supporting structures: 121215 or swing from ceiling bracket with wire: 20572, purchased separately.

For wall mounting: 121216, purchased separately

Spare part clutch rivet 14-pack: 121217-2.







## COBOGO

### Ceiling mount Cobogo

Bracket to suspend Cobogo from the ceiling.

121215-1	white	6.17/pc
121215-2	black	6.17/pc



### Mount for ceiling rail T24

When mounting in ceiling rail T24. See drawings at [www.gotessons.com](http://www.gotessons.com)

642041-1	white -2 black -3 grey	13.09/pc
----------	------------------------	----------

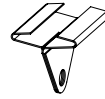

### Mount for ceiling rail T15

When mounting in ceiling rail T15. See drawings at [www.gotessons.com](http://www.gotessons.com)

642048-1	white -2 black 3-grey	11.17/pc
----------	-----------------------	----------



### Wire

Wire suspension. 2 m, adjustable.

20572		14,36/pc
-------	--	----------



### Wall mount Cobogo

Bracket to put Cobogo on the wall.

121216-1	white	6.17/pc
121216-2	black	6.17/pc



### Clutch rivet Cobogo

Spare parts 14-pack clutch rivet.

121217-2	black	14.36
----------	-------	-------



Rail set with aluminum rail in black or white powder coating. 2 brackets/wire suspension per rail. Maximum load 2,5 kg/rail. It is possible to swing the rail from the ceiling with a cable and suspension (121227). Extendable with joint fittings (121226+121228).

### Cobogo rail

Contains:

- 1 powder-coated aluminum rail, 2000 mm
- 1 twist stop with metal hook
- 2 plastic end caps
- 2 metal ceiling fittings
- 5 slides with metal hook

121218-1	white	183.51
121218-2	black	183.51

### Accessories

#### Rail connector

Material: plastic

121226	W. 19	white	22.45
--------	-------	-------	-------

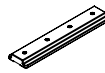

#### Rail wire suspension

Material: metal, L. 2000 mm, adjustable, 2-pack.

121227		white	43.19
--------	--	-------	-------



#### Rail 2000 mm

Material: powder coating

121228-1	W. 22	L. 2000	white	126.06
121228-2	W. 22	L. 2000	black	126.06

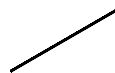

#### T24 fitting rail

Material: metal.

121229-1		white	21.38
----------	--	-------	-------

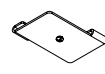

#### Wallmount rail

Material: metal.

121231-1		white	13.72
121231-2		black	13.72



#### Adjustable mount T24

Contains: 2 brackets.

Adjustable, means that you can fold down two different tinplates to swing down products in two different directions. Can not be hung directly on EcoSUND.

642044-1	white 2 black -3 silver	7.13
----------	-------------------------	------

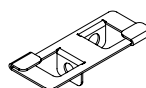



## OFF THE GRID CEILING

### Off the Grid ceiling

Off The Grid is only the metal frame with wires for suspension, 4 pcs included, 2 m long. Inner dimension depth 52 mm. With space for:  
 2 x Tiles Raw/Dressed EcoSUND to art.no 644030-  
 6 x TilesRaw/Dressed EcoSUND to art.no 644040-  
 Suits also Off the Grid absorbent.  
 Tiles, plants and lamps are bought separately.

644030-2	W. 1200	L. 600	D. 62	black	200.43
644030-3	W. 1200	L. 600	D. 62	silver	200.43
644030-20	W. 1200	L. 600	D. 62	brass	209.79
644040-2	W. 1800	L. 1200	D. 62	black	312.87
644040-3	W. 1800	L. 1200	D. 62	silver	312.87
644040-20	W. 1800	L. 1200	D. 62	brass	328.94

### Off the Grid absorbent

Absorbents in EcoSUND adapted for Off the Grid wire mesh. Fits both the model for the ceiling and for the wall.

126120-	W. 1200	L. 600	D. 50	raw	76,17
126121-	W. 1200	L. 600	D. 50	dressed	120,00
126122-	W. 1800	L. 1200	D. 50	raw	278,83
126123-	W. 1800	L. 1200	D. 50	dressed	377,45

### Off the Grid ceiling circle

Off The Grid is only the wire grid with wires for suspension, includes 4 wires, 2 m long. Inner dimension depth 52 mm. With room for Off the Grid absorbent. Plants and lights are purchased separately.

644103-2	Ø 772	D. 62	black	200.43
644103-3	Ø 772	D. 62	silver	200.43
644103-20	Ø 772	D. 62	brass	209.79
644105-2	Ø 1102	D. 62	black	251.49
644105-3	Ø 1102	D. 62	silver	251.49
644105-20	Ø 1102	D. 62	brass	261.38

### Off The Grid absorbent EcoSUND circle

126124-	Ø 750	D. 50	raw	109,04
126125-	Ø 750	D. 50	dressed	174,79
126126-	Ø 1080	D. 50	raw	152,87
126127-	Ø 1080	D. 50	dressed	229,57

For Off the Grid rectangular: choose Tiles raw EcoSUND in white, black or grey raw material or cover in Hush.

For Off the Grid circle: choose Off the Grid absorbent in white, black or grey raw material or dress in Hush.

### Mount for ceiling rail T24

When mounting in ceiling rail T24. See drawings at [www.gotessons.com](http://www.gotessons.com)  
 For Off the grid rectangular you need 4 mounts, for circle you need 1 mount.

642041-1	white -2 black	13.09/pc
----------	----------------	----------

### Mount for ceiling rail T15

When mounting in ceiling rail T15. See drawings at [www.gotessons.com](http://www.gotessons.com)

642048-1	white -2 black 3-grey	11.17/pc
----------	-----------------------	----------

### Adjustable mount T24

Contains: 2 brackets.

Adjustable, means that you can fold down two different tinplates to swing down products in two different directions. Can not be hung directly on EcoSUND.

642044-1	white 2 black -3 silver	7.13
----------	-------------------------	------

Important info: Can be mounted in any ceiling. Mounts 642041 or 642044 are needed for mounting in acoustic ceiling, are not included. Tiles with lighting are not recommended for Off the Grid.

## LIGHTING

### The Hut Lamp

5 m black textile-covered cord with switch and E27 socket. 3-step click attenuation, the light effect is easily changed by clicking on the switch. Lumens: 70 lm, 350 lm, 700 lm. Color temperature: 2100 K. Watt: 4 W. Mounting: earthed socket.

821020	142.77
--------	--------

### Bright

5 m black textile-covered cord with switch and E27 socket. (Dimmer not included.) Lumens: max 470 lm. Color temperature: 2700 K. Watt: 4 W. Mounting: unearthed socket.

821025	187.77
--------	--------

Add an eye-catching detail in the room and suspend Off the Grid from the ceiling. Place Tiles EcoSUND in the metal frame for a sound dampening effect and combine with lamps and garlands from our wide assortment of lighting and artificial plants. The wire frame is made of 5 mm thick steel.



1-2 garlands are recommended per small Off The Grid. The double amount of garlands and 6 pcs Tiles are recommended for the big Off The Grid.



An effective sound absorbing ceiling panel. Can be ordered with or without the LED light. Available in various styles and sizes. Made of recycled material. Thickness 50 mm. Sound Off EcoSUND is also available laminated with Hush textile and as a wall absorber.



Improve the acoustics in the room with ceiling mounted and sound absorbing Sound Off Cloud. The cloud shaped sound absorbers are made of our unique core material EcoSUND and can be chosen in its raw state in different colours or dressed in colours from textile Hush. Create a dynamic impression by hanging the cloud at different wire lengths. For a 2-in-1 solution of sound absorption and lighting, choose the version with one or three LED lamps.

## SOUND OFF ECOSUND® CEILING

### SOUND OFF ECOSUND CEILING

Included: 2 m wire mount with loop and adjustable hook. Hook for ceiling not included. Dressed Sound Off EcoSUND is dressed on the underside. The edge will be raw.

#### Sound Off EcoSUND circular without lamps

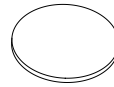

125300- Ø 800 D. 50	raw	130,96
125308- Ø 800 D. 50	dressed	215,74
125310- Ø 1100 D. 50	raw	176,17
125311- Ø 1100 D. 50	dressed	273,72
125320- Ø 1400 D. 50	raw	234,57
125324- Ø 1400 D. 50	dressed	345,96

#### Sound Off EcoSUND circular with one lamp

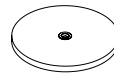

125318- Ø 800 D. 50	raw	328,40
125319- Ø 800 D. 50	dressed	416,81
125312- Ø 1100 D. 50	raw	360,43
125313- Ø 1100 D. 50	dressed	425,74
125314- Ø 1400 D. 50	raw	396,06
125315- Ø 1400 D. 50	dressed	476,17

#### Sound Off EcoSUND circular with three lamps

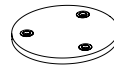

125303- Ø 800 D. 50	raw	526,91
125304- Ø 800 D. 50	dressed	613,72
125305- Ø 1100 D. 50	raw	570,43
125306- Ø 1100 D. 50	dressed	635,43
125309- Ø 1400 D. 50	raw	605,11
125307- Ø 1400 D. 50	dressed	685,21

## SOUND OFF CLOUD ECOSUND®

### Sound Off Cloud EcoSUND without lamp

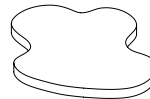

125100- Ø 800 D. 50	raw	130,96
125101- Ø 800 D. 50	dressed	215,74
125106- Ø 1100 D. 50	raw	176,17
125107- Ø 1100 D. 50	dressed	273,72
125112- Ø 1400 D. 50	raw	234,57
125113- Ø 1400 D. 50	dressed	345,96

### Sound Off Cloud EcoSUND with 1 lamp

125102- Ø 800 D. 50	raw	328,40
125103- Ø 800 D. 50	dressed	416,81
125108- Ø 1100 D. 50	raw	360,43
125109- Ø 1100 D. 50	dressed	425,74
125114- Ø 1400 D. 50	raw	404,36
125115- Ø 1400 D. 50	dressed	476,17

### Sound Off Cloud EcoSUND with 3 lamps

125104- Ø 800 D. 50	raw	526,91
125105- Ø 800 D. 50	dressed	613,72
125110- Ø 1100 D. 50	raw	570,43
125111- Ø 1100 D. 50	dressed	635,43
125116- Ø 1400 D. 50	raw	645,64
125117- Ø 1400 D. 50	dressed	685,21

Important info: mounting: see drawings on [www.gotessons.com](http://www.gotessons.com). Dimmable LED, are installed by an electrician.

### HOW TO ORDER SOUND OFF ECOSUND RAW

Art.No - Colour core.

Example: 125300-2 = Sound Off EcoSUND circular without lamps Ø 800, black core.

### HOW TO ORDER SOUND OFF ECOSUND WITH HUSH

Art.No - Colour textile - Edge colour (core/raw).

Example: 125308-567-1 = Sound Off EcoSUND circular without lamps Ø 800, with blue Hush and white edge. (core/raw).

### See textile chapter for textile and core material.

Colour code core material: white-1 black-2 grey-3 light grey-6

#### Mount for ceiling rail T24

When mounting in ceiling rail T24. See drawings at [www.gotessons.com](http://www.gotessons.com)

642041-1 white -2 black 13.09/pc



#### Mount for ceiling rail T15

When mounting in ceiling rail T15. See drawings at [www.gotessons.com](http://www.gotessons.com)

642048-1white -2 black 3-grey 11.17/pc



#### Adjustable mount T24

Contains: 2 brackets.

Adjustable, means that you can fold down two different tinplates to swing down products in two different directions. Can not be hung directly on EcoSUND.

642044-1 white 2 black -3 silver 7.13

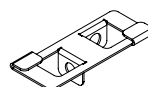



## HANG OVER

See price ranges in textile chapter.



**Hang Over small**  
678020- W. 598 D. 105

Pricer. 1	Pricer. 2	Pricer. 3	Pricer. 4
167,98	194,68	233,83	251,06

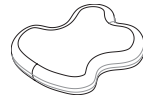

**Hang Over large**  
678030- W. 810 D. 130

234,36	274,26	325,32	384,47
--------	--------	--------	--------

### HOW TO ORDER HANG OVER

1. Select Hang Over size.
2. Select textile colour (see colour map at page 6-16).
3. Select zip colour (see colours on page 17).
4. Select ceiling mount.



### Ceiling mount for Hang Over

Loop and wire 2 m.  
642013

16.70



### Mount for ceiling rail T24

When mounting in ceiling rail. See drawings at [www.gotessons.com](http://www.gotessons.com)

642041-1 white -2 black

13.09/pc



### Mount for ceiling rail T15

When mounting in ceiling rail T15. See drawings at [www.gotessons.com](http://www.gotessons.com)

642048-1 white -2 black 3-grey

11.17/pc

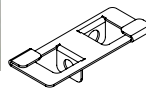

### Adjustable mount T24

Contains: 2 brackets.

Adjustable, means that you can fold down two different tinplates to swing down products in two different directions. Can not be hung directly on EcoSUND.

642044-1 white -2 black -3 silver

7.13

Can only be ordered with a zip. Is mounted to the ceiling with screws or strung from the ceiling with an adjustable wire. Hooks and wires for the ceiling are not included. For exact measurements, see [www.gotessons.com](http://www.gotessons.com)



## NIVÅ ECOSUND® CEILING PANEL

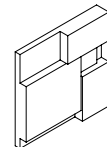

### Nivå EcoSUND ceiling panel

125595- W. 593 D. 593  
125596- W. 593 D. 593

raw	88,94
dressed	134,04

### HOW TO ORDER NIVÅ ECOSUND RAW

Art.No - Colour core.

Example: 125595-2 = Nivå EcoSUND with black core.

### HOW TO ORDER NIVÅ ECOSUND WITH HUSH

Art.No - Colour textile - Edge colour (core).

Example: 125596-567-1 = Nivå EcoSUND with blue Hush and white edge (core).

Colour code core material: white-1 black-2 grey-3 light grey-6

Facts: Nivå is manufactured in dimensions of 593x593 mm in two versions, one to work as a wall panel sound absorbent, the other to fit grid systems for ceilings. Thickness varies across the surface from 30-90 mm. Nivå dressed can only be ordered in Hush textile. See textiles and core material in textile chapter.



Nivå improves acoustics and its design makes it a feature in any room. The panels can be varied to form different patterns in different colours, with or without textile. Nivå is made of our unique core material EcoSUND. Our core material is available in four colours, and with the possibility of laminating with several different textiles, your ceiling becomes almost unique.



## EFFEKT ECOSUND® PENDENT

### Effekt EcoSUND Pendent

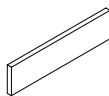

125120-	W. 1200	H. 300	D. 50	raw	54,47
125121-	W. 1200	H. 300	D. 50	dressed	101,06
125122-	W. 1200	H. 600	D. 50	raw	93,72
125123-	W. 1200	H. 600	D. 50	dressed	184,68
125124-	W. 1200	H. 900	D. 50	raw	146,28
125125-	W. 1200	H. 900	D. 50	dressed	278,62

### HOW TO ORDER EFFEKT ECOSUND RAW

Art.No - Colour core/raw.

Example: 125122-2 = Effekt EcoSUND 1200x600x50 with black core/raw.

### HOW TO ORDER EFFEKT ECOSUND WITH HUSH

Art.No - Colour textile - Edge colour (core/raw).

Example: 125123-567-1 = Effekt EcoSUND 1200x600x50 with blue Hush and white edge (core/raw).

Colour code core material: white-1 black-2 grey-3 light grey-6

Facts: Effekt EcoSUND dressed can only be ordered in Hush textile.  
See textiles and core materia in the textile chapter.

### EFFEKT HANG WIRES

Hang wire to hang Effekt EcoSUND Pendent from the ceiling or under already existing Effekt.



#### Hang wires Effekt EcoSUND Pendent 300 mm

Suitable for Effekt EcoSUND Pendent 1200x300x50.

643000-1 white -2 black -3 silver 30.00/2pcs

#### Hang wires Effekt EcoSUND Pendent 600 mm

Suitable for Effekt EcoSUND Pendent 1200x600x50.

646000-1 white -2 black -3 silver 31.81/2pcs

#### Hang wires Effekt EcoSUND Pendent 900 mm

Suitable for Effekt EcoSUND Pendent 1200x900x50.

649000-1 white -2 black -3 silver 35.21/2pcs

### EFFEKT WIRE HOOKS

Wire hooks to get space when using Effekt EcoSund as a room divider.



#### Wire hooks Effekt EcoSUND Pendent 300 mm

Use to get space between Effect EcoSUND Pendent 1200x300x50 when used as a divider.

643001-1 white -2 black -3 silver 18.30/2pcs

#### Wire hooks Effekt EcoSUND Pendent 600 mm

Use to get space between Effect EcoSUND Pendent 1200x600x50 when used as a divider.

646001-1 white -2 black -3 silver 22.87/2pcs

#### Wire hooks Effekt EcoSUND Pendent 900 mm

Use to get space between Effect EcoSUND Pendent 1200x900x50 when used as a divider.

649001-1 white -2 black -3 silver 26.06/2pcs

Tip! For mounting Effekt Pendent from floor to ceiling, visit gotessons.se for more measurements regarding hang wires/wire hooks/clamp packets.

### Effekt ceiling package

Content: S hook (silver), angle mount for ceiling and clips for ceiling rail.

643002-1 white -2 black 38.09/2pcs



### Adjustable mount T24

Contains: 2 brackets.

Adjustable, means that you can fold down two different tinplates to swing down products in two different directions. Can not be hung directly on EcoSUND.

642044-1 white 2 black -3 silver 7.13

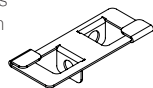

An effective way to improve the acoustics without having to change existing installations such as ventilation, cables, lights, etc. is to mount Effekt Pendent ceiling absorbers. An affordable solution that reduces noise reflexes and sound propagation in the room. Customize your absorbers by choosing from four core materials and laminate them with the Hush textile, available in several different colours.

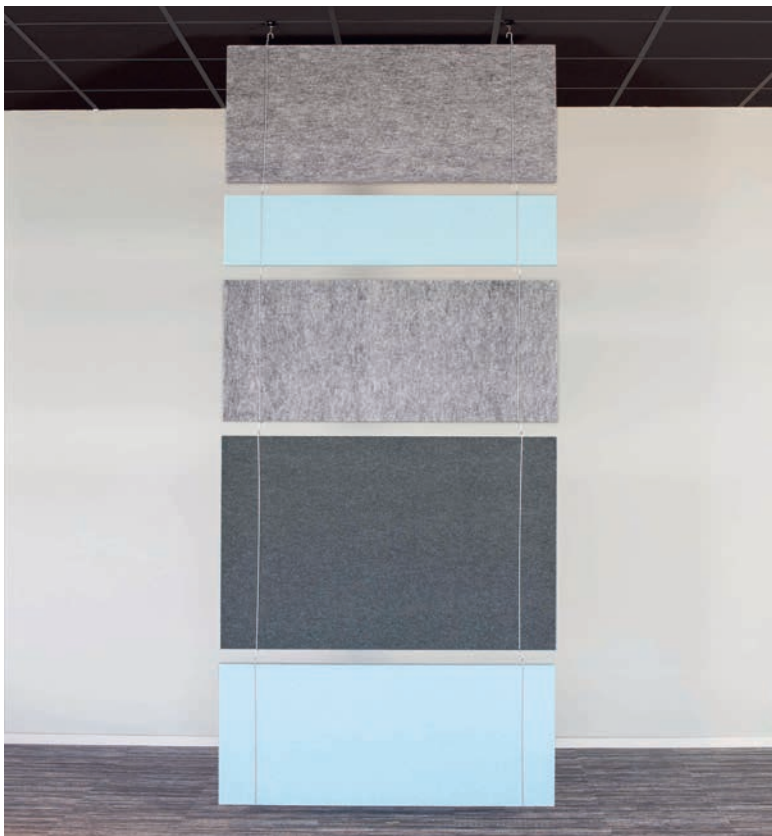

Effekt is hung in hang wires that are connected and form a wall. An affordable solution that reduces noise reflexes and sound propagation in the room and divides the room into smaller rooms. Design your unique room divider by choosing from four different colours of EcoSUND, 3 different hang wires, and a variety of colours from the Hush textile. Effekt is not recommended for climbing.





# WALL

A good sound environment has a direct connection to our wellbeing. We have sound absorbents that are designed to be mounted on the wall and ceiling and to suit all types of environments. Our absorbents are made of EcoSUND, a unique sound absorbing core material produced together with acousticians for optimal sound absorption. EcoSUND is available in several colours and our products can be chosen in their raw material, be dressed with textile, printed, cut into different shapes and customised to suit your needs.



## LINK WALL

Link is designed to function as a standalone design and create new patterns the more you have on the ceiling or wall. The straight wires create a contrast to the round shapes, and through the wires, a completely new expression is achieved. By placing them straight, a linear design is created. By varying the wire direction, the design becomes more abstract. The design of the wires is inspired by the sound waves they are meant to absorb.

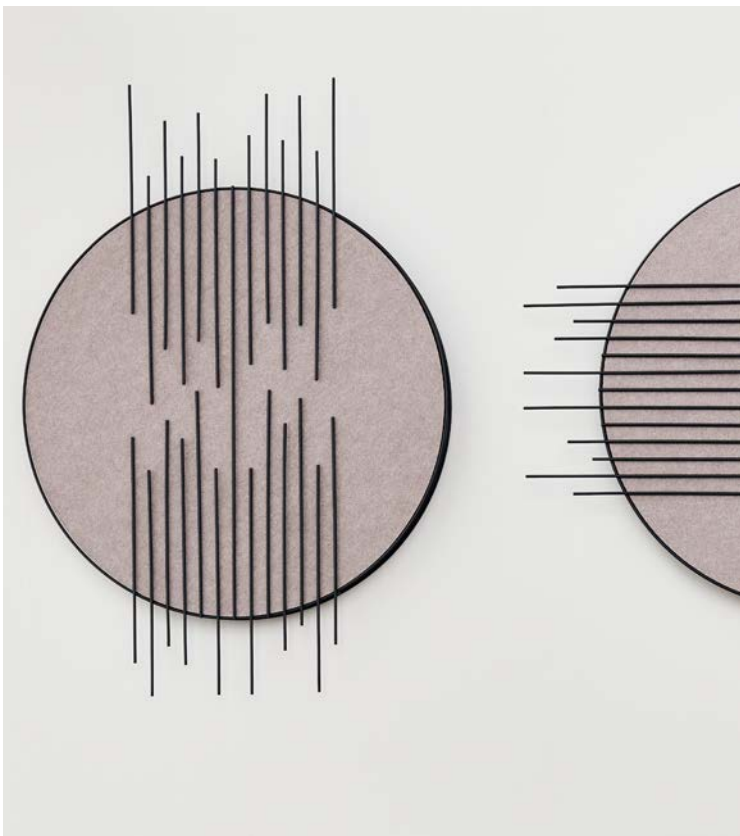

### Link wall

Link is a wire grid with 6 pcs hanging clips for wall mounting.  
With space for Off the Grid absorbent. Inner dimension 52 mm.  
Material: 5 mm steel wire.

644110-2	Ø 772	W. 1100	D. 62	black	286,70
----------	-------	---------	-------	-------	--------

### Off The Grid absorbent EcoSUND circle

126124-	Ø 750	D. 50	raw	109,04
126125-	Ø 750	D. 50	dressed	174,79

For Off the Grid circle: choose Off the Grid absorbent in white, black or grey raw material or dress in Hush. See textiles in the textile chapter.

Can also be mounted on ceilings, see the ceiling chapter.



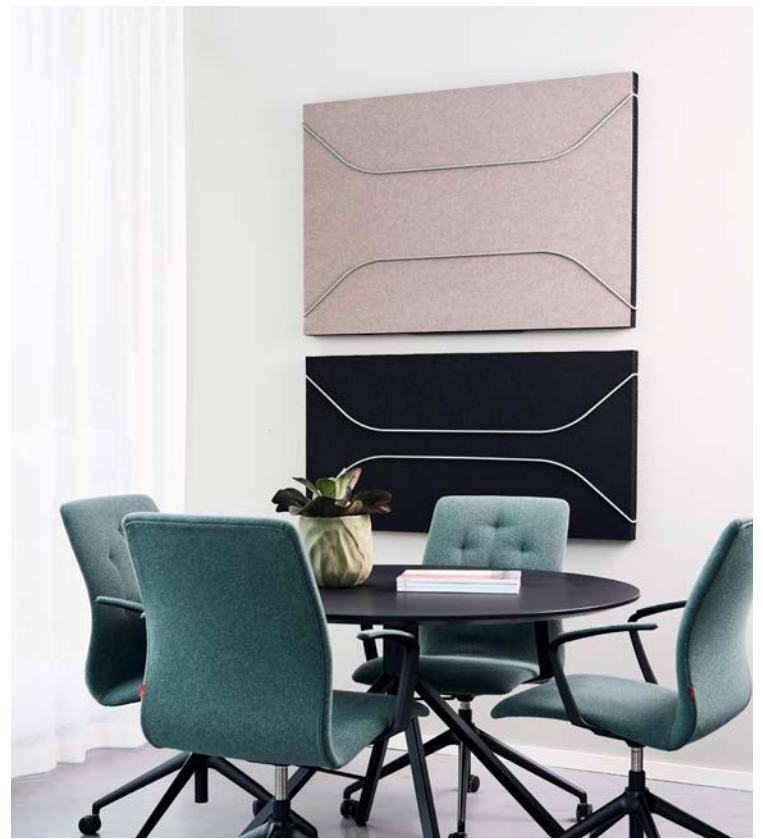

## CLAMP DESIGN

Clamp design consists of two metal brackets that are attached to the ceiling or wall and then combined with the EcoSUND effect. Clamp becomes a discreet and stylish suspension for sound absorbers where the focus is on highlighting the material to achieve maximum sound absorption.

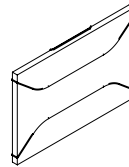

### Clamp Design

Brackets are mounted on the ceiling or on the wall.

Fits Effekt with width 1200 mm.

Material: powder coated metal. 2 brackets included, screw not included.

The clamps builds 260 mm into the absorber.

644108-1	W. 1200	H. 200	D. 62	white	84,57
644108-2	W. 1200	H. 200	D. 62	black	84,57
644108-21	W. 1200	H. 200	D. 62	greengrey	84,57

### Effekt EcoSUND ceiling/wall

125130-	W. 1200	H. 600	D. 50	raw	88,30
125131-	W. 1200	H. 600	D. 50	dressed	153,19
125132-	W. 1200	H. 900	D. 50	raw	131,60
125133-	W. 1200	H. 900	D. 50	dressed	191,28
125135-	W. 1200	H. 1200	D. 50	raw	180,85
125134-	W. 1200	H. 1200	D. 50	dressed	244,68

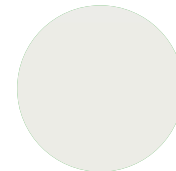

Colour: -1 white  
(RAL 9003, GL 30)

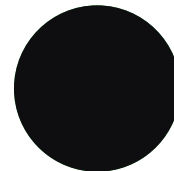

Colour: -2 black  
(RAL 9005, GL 30)

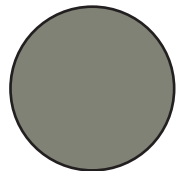

Colour: -21 greengrey  
(RAL 7033, GL 30)

Can also be mounted on ceilings, see the ceiling chapter.



## WALL PANEL TRACKS

Cover parts or an entire wall with Wallpanel Tracks, which resemble a ribbed wooden acoustic wall, but consist of cut-out acoustic panels. The top layer is covered in a brown textile, the raw material is anthracite grey, which enhances the feeling of wood on the outside..

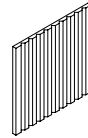
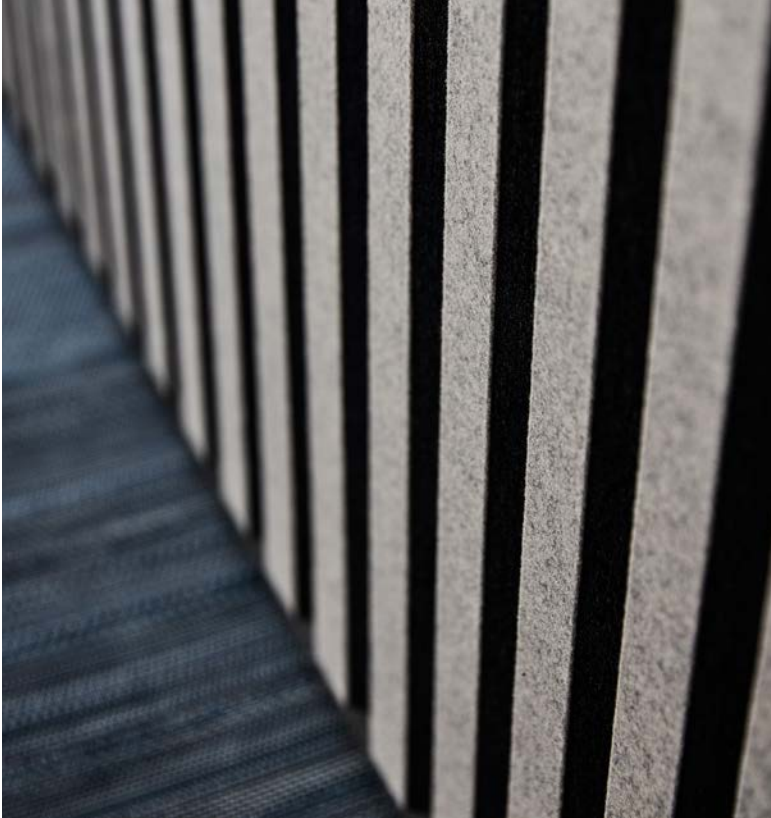

### Wall panel Tracks

*Material: Pressed polyester fiber. Mounted on the wall, 8 screws included.  
W. 600 H. 3000 D. 25*

121460-11

grey/brown\*

611.70

*\*The top layer is laminated with textile Textel®.*



## FLORA PANEL

Plant panel to place on the wall, for example together with Plain/Plant panel. Several different plants sit close together to create a green oasis.



Flora panel 1



Flora panel 2



Flora panel 3

### Flora panel 1

Materials: Artificial plants, black wooden frame.  
W. 580 H. 580 D. 30

160125

382.45

### Flora panel 2

Materials: Artificial plants, black wooden frame.  
W. 580 H. 580 D. 30

160126

382.45

### Flora panel 3

Materials: Artificial plants, black wooden frame.  
W. 580 H. 580 D. 30

160127

382.45

---

Mounting on the wall with two metal fittings located on the back of the panel.  
Customer is responsible for suitable screw on wall.



SlicePanel and SlicePanel Plant are two wall decorations in molded felt. One that is adapted for plants and one without the ability to add plants. The wavy pattern creates a cool visual effect and we recommend you to combine the two models. The model for plants you find in the pots and plants chapter, page 148-149. Design Henrik Kjellberg and Jon Lindström, o4i Design Studio.

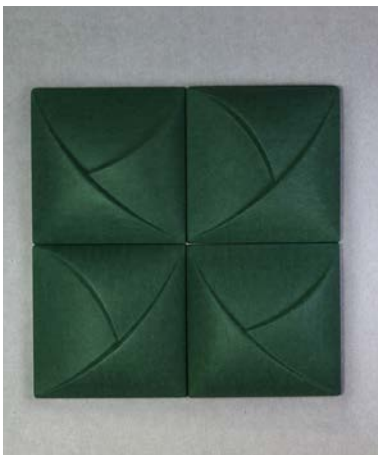

## SLICEPANEL

### SlicePanel

Moulded felt made of at least 55 % recycled PET. Mounted on the wall with rail, suspension included.

W. 580 H. 580 D. 140

121361-1	gravel	201.60
121361-2	slate	201.60
121361-3	pine	201.60
121361-4	moss	201.60
121361-5	plum	201.60
121361-6	cherry	201.60
121361-7	cyan	201.60
121361-8	ivory	201.60
121361-9	hemp	201.60



## LEAFPANEL

### LeafPanel

Moulded felt made of at least 55% recycled PET. Mounted on the wall with rail, suspension included.

W. 580 H. 580 D. 100

121360-1	gravel	201.60
121360-2	slate	201.60
121360-3	pine	201.60
121360-4	moss	201.60
121360-5	plum	201.60
121360-6	cherry	201.60
121360-7	cyan	201.60
121360-8	ivory	201.60
121360-9	hemp	201.60

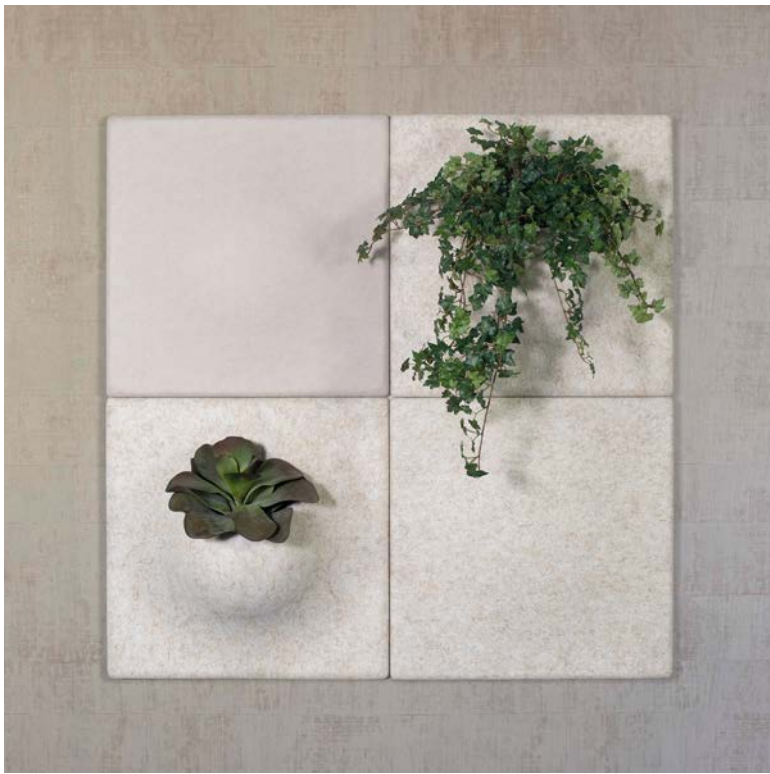

Create a striking wall in the room with the help of Wallpanels. Consists of molded felt and can be ordered in several different colors for more effect.

## PLAINPANEL

### PlainPanel

Moulded felt made of at least 55% recycled PET. Mounted on the wall with included wall mount.

W. 580 H. 580 D. 60

121211-1	gravel	162.45
121211-2	slate	162.45
121211-3	pine	162.45
121211-4	moss	162.45
121211-5	plum	162.45
121211-6	cherry	162.45
121211-7	cyan	162.45
121211-8	ivory	162.45
121211-9	hemp	162.45

### PlantPanel

Moulded felt made of at least 55% recycled PET. Mounted on the wall with included wall mount. Pot for artificial plant included, inner dimensions Ø 140, H. 130.

W. 580 H. 580 D. 210

121210-1	gravel	229.04
121210-2	slate	229.04
121210-3	pine	229.04
121210-4	moss	229.04
121210-5	plum	229.04
121210-6	cherry	229.04
121210-7	cyan	229.04
121210-8	ivory	229.04
121210-9	hemp	229.04

### EcoSUND for Wallpanels

Place behind Wallpanels for sound absorption. Only raw white EcoSUND.

W. 480 H. 570 D. 20

126400-1	white	20,74
----------	-------	-------



Spring



Coastline



Sunset

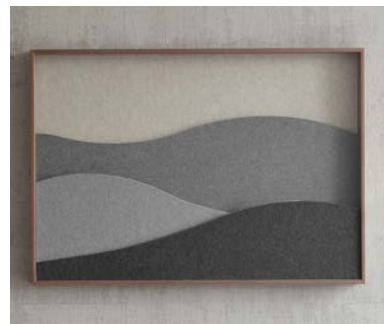

Mist

Apply this creation to the wall, a print in our sound absorbing material EcoSUND in different colors and levels. Frame with wood veneer.

## LANDSCAPE ECOSUND®

Cut out shapes in different thickness 8, 20, 40 and 50 mm. Dressed in various Hush textiles. Colours can not be changed. Frame in wood veneer.

### Landscape Spring

Textile Hush: 61174, 68160, 61225, 68103.

121350-1	W. 524	H. 724	D. 60	ash	470.64
121350-2	W. 524	H. 724	D. 60	oak	470.64
121350-3	W. 524	H. 724	D. 60	walnut	470.64
121353-1	W. 1024	H. 724	D. 60	ash	645.96
121353-2	W. 1024	H. 724	D. 60	oak	645.96
121353-3	W. 1024	H. 724	D. 60	walnut	645.96

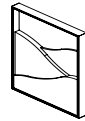

### Landscape Coastline

Textile Hush: 66169, 60159, 66133, 60155.

121351-1	W. 524	H. 724	D. 60	ash	470.64
121351-2	W. 524	H. 724	D. 60	oak	470.64
121351-3	W. 524	H. 724	D. 60	walnut	470.64
121354-1	W. 1024	H. 724	D. 60	ash	645.96
121354-2	W. 1024	H. 724	D. 60	oak	645.96
121354-3	W. 1024	H. 724	D. 60	walnut	645.96

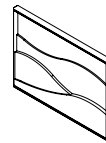

### Landscape Sunset

Textile Hush: 64148, 63058, 61225, 61174, 63058.

121352-1	W. 524	H. 724	D. 60	ash	470.64
121352-2	W. 524	H. 724	D. 60	oak	470.64
121352-3	W. 524	H. 724	D. 60	walnut	470.64
121355-1	W. 1024	H. 724	D. 60	ash	645.96
121355-2	W. 1024	H. 724	D. 60	oak	645.96
121355-3	W. 1024	H. 724	D. 60	walnut	645.96

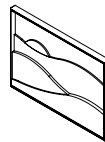

### Landscape Mist

Textile Hush: 61226, 60158, 60159, 60900.

121356-1	W. 524	H. 724	D. 60	ash	470.64
121356-2	W. 524	H. 724	D. 60	oak	470.64
121356-3	W. 524	H. 724	D. 60	walnut	470.64
121357-1	W. 1024	H. 724	D. 60	ash	645.96
121357-2	W. 1024	H. 724	D. 60	oak	645.96
121357-3	W. 1024	H. 724	D. 60	walnut	645.96





Honey is a playful and modular wall panel that can be varied to form different patterns in different colours, with or without textile. All panels have good sound absorbing properties. Honey is made with a straight edge and comes with velour backing for easy mounting with Hook & Loop tape. The sound absorbent is made from our unique core material EcoSUND. Our core material is available in four colours and with the ability to dress textiles in several colours your wall becomes almost unique.

## HONEY ECOSUND® WALL PANEL

### Honey EcoSUND wall panel

125520-	W. 600	H. 520	D. 20	raw	60,32
125521-	W. 600	H. 520	D. 20	dressed	77,34
125522-	W. 600	H. 520	D. 40	raw	63,83
125523-	W. 600	H. 520	D. 40	dressed	106,81
125524-	W. 600	H. 520	D. 50	raw	67,23
125525-	W. 600	H. 520	D. 50	dressed	123,83

### HOW TO ORDER HONEY ECOSUND RAW

Art.No - Colour core.

Example: 125520-2 = Honey EcoSUND 600x520x20 with black core.

### HOW TO ORDER HONEY ECOSUND WITH HUSH

Art.No - Colour textile - Edge colour (core).

Example: 125521-567-1 = Honey EcoSUND 600x520x20 with blue Hush and white edge. (core).

Important information: Honey is manufactured with a straight edge for even corners and velour backing for easy assembly with Hook & Loop tape. Dressed Honey can only be ordered in the textile Hush. The edge becomes raw. Our core material is available in four colors and with the option to dress with textile in several colors. See textiles and core materials in the textile chapter.

Colour code core material: white-1 black-2 grey-3 light grey-6

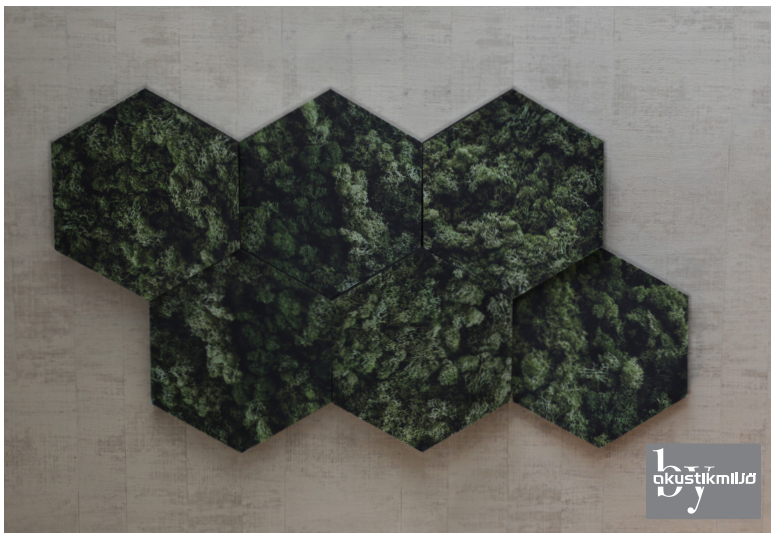

Honey print is a playful wall absorbent with beehive-shaped panels in three different thicknesses that together create an effective 3D feeling in the room. Honey print is available in several patterns inspired by nature.

## HONEY ECOSUND® MOSS PRINT

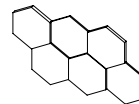

### Honey Moss print

Comes in 6-packs, two of each thickness, 20, 40, 50 mm. Always the same motif, with reservation for certain pattern variation. Pattern matching is not required. Core material: black.

121340-2 W. 1819 H. 1050 D. 50

821.28



## HONEY ECOSUND® RUST PRINT

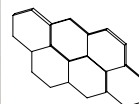

### Honey Rust print

Comes in 6-packs, two of each thickness, 20, 40, 50 mm. Always the same motif, with reservation for certain pattern variation. Pattern matching is not required. Core material: black.

121341-2 W. 1819 H. 1050 D. 50

821.28

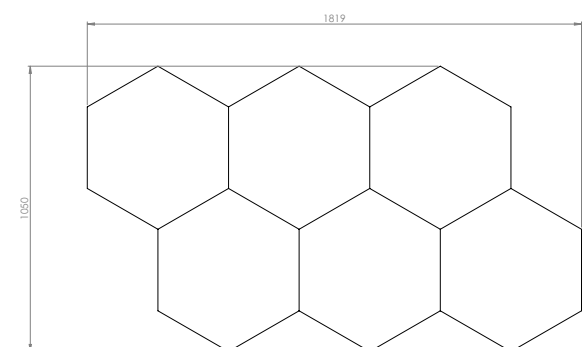



## HONEY ECOSUND® CLIFF PRINT

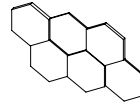

### Honey Cliff print

Comes in 6-packs, two of each thickness, 20, 40, 50 mm. Always the same motif, with reservation for certain pattern variation. Pattern matching is not required. Core material: grey.

121342-3 W. 1819 H. 1050 D. 50

821.28



## HONEY ECOSUND® AQUA PRINT

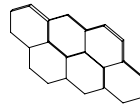

### Honey Aqua print

Comes in 6-packs, two of each thickness, 20, 40, 50 mm. Always the same motif, with reservation for certain pattern variation. Pattern matching is not required. Core material: grey.

121343-3 W. 1819 H. 1050 D. 50

821.28

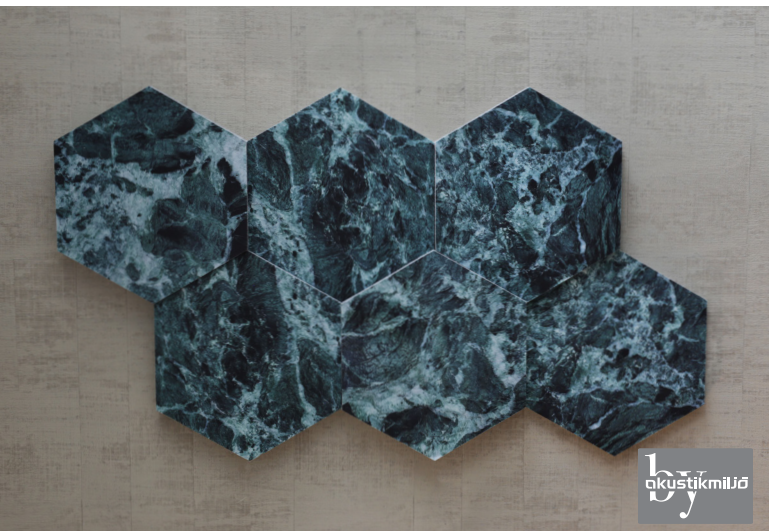

## HONEY ECOSUND® HEAVEN PRINT

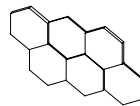

### Honey Heaven print

Comes in 6-packs, two of each thickness, 20, 40, 50 mm. Always the same motif, with reservation for certain pattern variation. Pattern matching is not required. Core material: grey.

121344-3 W. 1819 H. 1050 D. 50

821.28

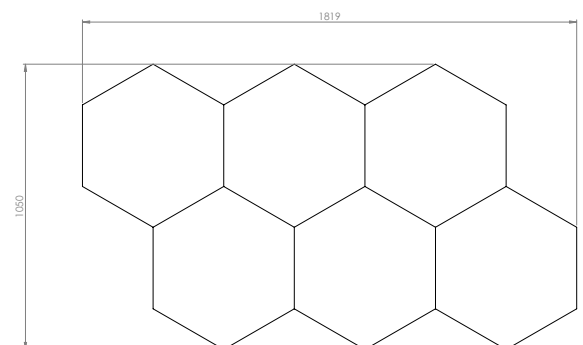

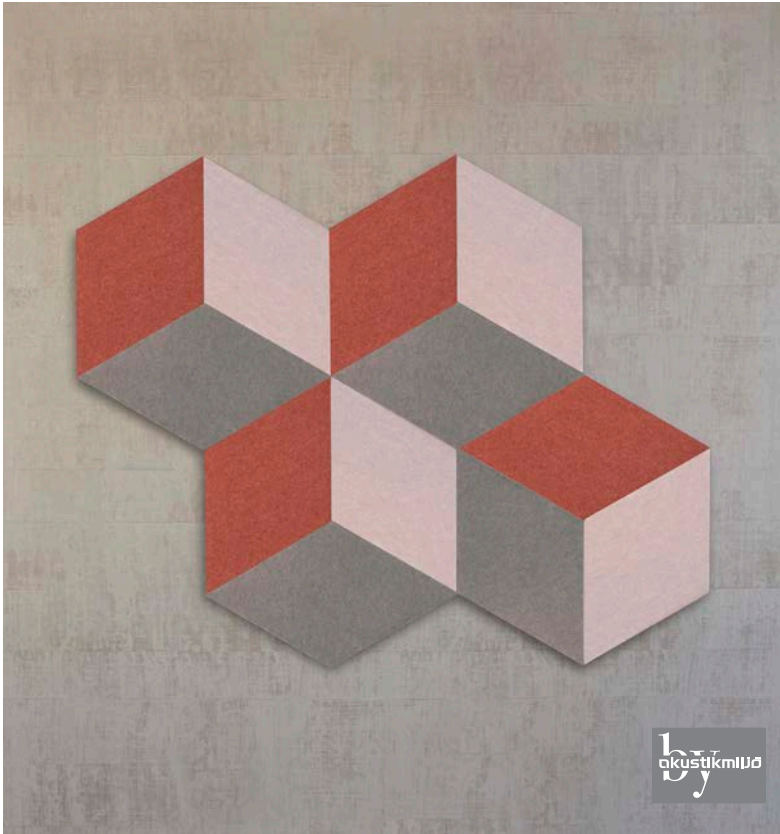

## CUBISM ECOSUND®

### Cubism

Sound absorbing wall absorbent. Core material EcoSUND.

Upholstered: Hush, edge in raw core, black, grey or light grey.

Thickness: 50 mm.

An absorbent/panel has the dimensions 450x260 mm.

There are 12 panels in a package that has 3 different color schemes.

Assembly: Velor-covered back and Hook & Loop tape.

The colour combinations are predetermined.

Dressed in colors from the Hush textile.

o 121290-2 Ash - Hush 4x60155, 4x60159, 4x60900 with black core

o 121291-2 Ocean - Hush 4x60155, 4x60159, 4x67046 with black core

o 121292-3 Lava - Hush 4x61225, 4x64148, 4x63058 with grey core

o 121293-6 Forest - Hush 4x68103, 4x61226, 4x68160 with light grey core

121290-2	ash	244.89/set
121291-2	ocean	244.89/set
121292-3	lava	244.89/set
121293-6	forest	244.89/set

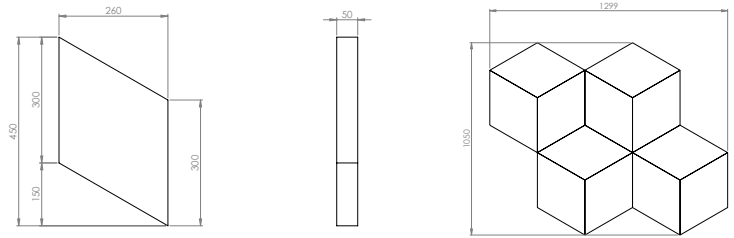

Cubism is a playful sound absorber with diamond-shaped panels that can be varied to create unique patterns in different colors.



## WOODSTOCK ECOSUND®

### Woodstock EcoSUND

The circles edges will be raw in white, black, grey or bronze brown.

121212-1	white	797.34
121212-2	black	797.34
121212-3	grey	797.34
121212-4	bronze brown	797.34
121212-6	light grey	797.34

Each packet includes 12 circles:

4 x Ø250x50 mm

4 x Ø300x40 mm

4 x Ø350x20 mm

To create a dynamic pattern, each size group is printed with a different image.

Facts: Wallmount with Hook & Loop tape included. The edge will be raw.

Colour code core material: white-1 black-2 grey-3 bronze brown-4 light grey-6

Bring nature inside. The circles are made with the environmentally friendly and sound absorbing material EcoSUND and are then printed with different images of trees' age rings. Combine the twelve circles in the order you find most harmonious and enjoy how good looking good acoustics can be. Perfect for settings like offices, conference rooms and hotels.



## SOUND OFF ECOSUND® WALL

### Sound Off EcoSUND wall

125384-	Ø 800	D. 50	raw	130,96
125385-	Ø 800	D. 50	dressed	215,74
125386-	Ø 1100	D. 50	raw	176,17
125387-	Ø 1100	D. 50	dressed	273,72
125388-	Ø 1400	D. 50	raw	234,57
125389-	Ø 1400	D. 50	dressed	345,96

### Sound Off EcoSUND wall square

125390-	W. 600	H. 600	D. 50	raw	110,00
125391-	W. 600	H. 600	D. 50	dressed	183,30
125392-	W. 800	H. 800	D. 50	raw	149,36
125393-	W. 800	H. 800	D. 50	dressed	260,85
125394-	W. 1000	H. 1000	D. 50	raw	176,81
125395-	W. 1000	H. 1000	D. 50	dressed	299,89
125404-	W. 600	H. 600	D. 40	raw	98,09
125405-	W. 600	H. 600	D. 40	dressed	156,06
125408-	W. 800	H. 800	D. 40	raw	131,70
125409-	W. 800	H. 800	D. 40	dressed	208,83
125412-	W. 1000	H. 1000	D. 40	raw	169,47
125413-	W. 1000	H. 1000	D. 40	dressed	269,47
125406-	W. 600	H. 600	D. 20	raw	80,43
125407-	W. 600	H. 600	D. 20	dressed	131,70
125410-	W. 800	H. 800	D. 20	raw	120,96
125411-	W. 800	H. 800	D. 20	dressed	181,70
125414-	W. 1000	H. 1000	D. 20	raw	142,45
125415-	W. 1000	H. 1000	D. 20	dressed	235,74

### Sound Off EcoSUND wall rektangulär

125416-	W. 600	H. 300	D. 50	raw	64,15
125417-	W. 600	H. 300	D. 50	dressed	103,30
125396-	W. 800	H. 600	D. 50	raw	122,45
125397-	W. 800	H. 600	D. 50	dressed	216,17
125398-	W. 1000	H. 600	D. 50	raw	126,28
125399-	W. 1000	H. 600	D. 50	dressed	237,87
125438-	W. 1200	H. 300	D. 50	raw	128,94
125439-	W. 1200	H. 300	D. 50	dressed	181,70
125400-	W. 1200	H. 600	D. 50	raw	134,79
125401-	W. 1200	H. 600	D. 50	dressed	277,02
125402-	W. 1200	H. 1000	D. 50	raw	177,98
125403-	W. 1200	H. 1000	D. 50	dressed	342,34
125418-	W. 600	H. 300	D. 40	raw	56,06
125419-	W. 600	H. 300	D. 40	dressed	80,43
125422-	W. 800	H. 600	D. 40	raw	114,15
125423-	W. 800	H. 600	D. 40	dressed	174,89
125426-	W. 1000	H. 600	D. 40	raw	123,62
125427-	W. 1000	H. 600	D. 40	dressed	207,34
125440-	W. 1200	H. 300	D. 40	raw	119,57
125441-	W. 1200	H. 300	D. 40	dressed	149,36
125430-	W. 1200	H. 600	D. 40	raw	132,98
125431-	W. 1200	H. 600	D. 40	dressed	233,09
125434-	W. 1200	H. 1000	D. 40	raw	174,89
125435-	W. 1200	H. 1000	D. 40	dressed	303,19
125420-	W. 600	H. 300	D. 20	raw	47,98
125421-	W. 600	H. 300	D. 20	dressed	66,81
125424-	W. 800	H. 600	D. 20	raw	101,91
125425-	W. 800	H. 600	D. 20	dressed	147,77
125428-	W. 1000	H. 600	D. 20	raw	118,09
125429-	W. 1000	H. 600	D. 20	dressed	179,04
125442-	W. 1200	H. 300	D. 20	raw	105,96
125443-	W. 1200	H. 300	D. 20	dressed	134,36
125432-	W. 1200	H. 600	D. 20	raw	123,62
125433-	W. 1200	H. 600	D. 20	dressed	211,38
125436-	W. 1200	H. 1000	D. 20	raw	162,87
125437-	W. 1200	H. 1000	D. 20	dressed	270,85

Facts: Wall mount with Hook & Loop tape included. The edge will be raw.

#### HOW TO ORDER SOUND OFF ECOSUND RAW

Art.No - Colour core.

Example: 125390-2 = Sound Off 600x600 with black core.

#### HOW TO ORDER SOUND OFF ECOSUND WITH HUSH

Art.No - Colour textile - Edge colour (core/raw)

Example: 125391-560-1 = Sound Off 600x600 in grey Hush and white edge (core/raw).

See textile chapter for textile and core material.

#### Distance

50 mm wall distances for Sound Off. 8 distances included. Screw for wall is included.

642057 D. 50

47.66

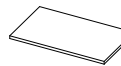
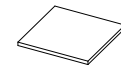
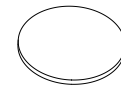

A very good sound absorber for hanging on the wall consisting of recycled material. Available in different types and sizes. Sound Off can only be ordered with Hush.

Colour code core material: white-1 black-2 grey-3 light grey-6



# DESIGN YOUR OWN PRINT BOARD

Absorbents with print not only improve the sound environment, they are also a simple and playful way to visually change and create a stylish interior design in everything from offices and conference rooms to public rooms and restaurants.

Print is sound-absorbing art where the image motif is printed on a canvas that is laminated onto our sound-absorbing core material EcoSUND. A simple means that creates a personal atmosphere and improves the sound environment.

Our prints are available with different frames and sizes. Read more on the following pages.

In our new Print Shop at [gotessons.com](http://gotessons.com), you can make your own painting.



## MOTIVE

Choose a design from one of our image banks, either the royalty-free collection or the one featuring our artist collaborations. You can also use your own image.



### ROYALTY FREE PICTURES

You can choose your own motif or choose pictures or illustrations from our image bank or one of many image banks on the internet.



### PICTURES WITH ROYALTY

Be inspired and choose motifs from our image bank with pieces from both innovative as well as traditional artists, photographers and photo artists, such as this piece of art from Soul Image.

## FRAMING

You can get our prints with a hidden frame, a straight-cut edge, a lacquered metal frame in black, white, or gray, or a wooden frame covered with walnut or oak veneer.



white



black



grey



oak



walnut

**Print with frame:** mounted using two or four screws in pre-punched keyholes in the frame or on a mounting rail, sold separately. The frame is 15 mm wide with a gloss level of 30.

**Print with wooden frame:** mounted using two or four screws in pre-punched keyholes in the frame.

**Print with hidden frame:** positioned beneath the print canvas and mounted using two or four screws in pre-punched keyholes in the frame or on a mounting rail, sold separately.

**Print with straight-cut edge:** features a velour-lined back and hook and loop strips that are screwed or stapled to the wall.

## SIZE

Choose the size of your artwork. Our standard sizes are 600x600, 1200x600, 1200x1200, 1200x900, and 1200x1600. Wooden frames are available in 1200x1200 and 1200x1600.

Custom sizes can be made upon request.

Example:



1200x600



1200x900

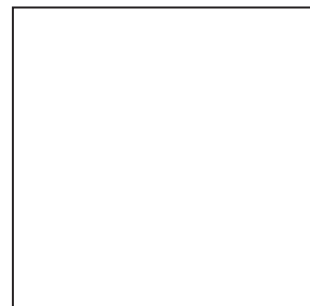

1200x1200



## PRINT ECOSUND® WITH METAL FRAME

Print EcoSUND with metal frame in white, black or grey

Material: EcoSUND 50 mm. Prices refer to our image bank and those sent in by the customer.

129803-	W. 600	H. 600	D. 50	393,51
129804-	W. 1200	H. 600	D. 50	508,94
129805-	W. 1200	H. 900	D. 50	744,89
129806-	W. 1200	H. 1200	D. 50	783,30
129807-	W. 1600	H. 1200	D. 50	1095,21
129808-	W. 2400*	H. 1200	D. 50	1419,26

### Mounting strip Dikt for frame

List for wall mount.

346000	320 mm (for print/absorbent 600 mm)	12.13
349000	620 mm (for print/absorbent 900 mm)	13.09
341200	920 mm (for print/absorbent 1200 mm)	14.04
341600	1320 mm (for print/absorbent 1600 mm)	17.87
342400	2120 mm (for print/absorbent 2400 mm)	26.49



### ORDER PRINT ECOSUND WITH FRAME

1. Choose format
2. Choose frame colour (see page 16)
3. Choose image
4. Choose length of mounting strip.

Quotes are offered for Print with photographs and art by the artists Gotessons collaborate with, and images Gotessons buys.

\*For orders of W. 2400 mm, minimum quantity: 5 pcs. For quantity less than 5 pcs, we recommend Big Print.



## PRINT ECOSUND® WITH WOODEN FRAME

Print EcoSUND with wooden frame covered with oak or walnut veneer

Material: EcoSUND 40 mm. Suspension fittings included. List is not needed.

129819-	W. 1200	H. 1200	D. 60	1164,36
129820-	W. 1600	H. 1200	D. 60	1483,51





## PRINT ECOSUND® WITH STRAIGHT CUT EDGE

### Print EcoSUND with straight cut edge

Prices refer to our image bank and those sent in by the customer.

129809-	W. 600	H. 600	D. 50	268,19
129810-	W. 1200	H. 600	D. 50	368,62
129811-	W. 1200	H. 900	D. 50	607,87
129812-	W. 1200	H. 1200	D. 50	641,28

### ORDER PRINT ECOSUND STRAIGHT CUT EDGE

1. Choose format
2. Choose colour of raw material EcoSUND (see page 16)
3. Choose picture

Quotes are offered for Print with photographs and art by the artists Gotessons collaborate with, and images Gotessons buys.

Colour code core material: white-1 black-2 grey-3 light grey-6

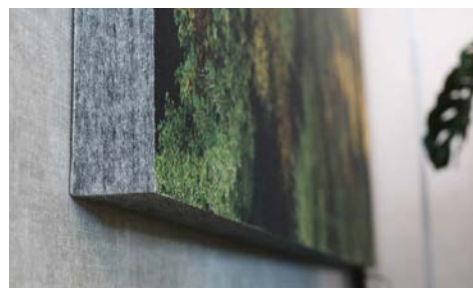

## PRINT ECOSUND® WITH CONCEALED FRAME

### Print with concealed frame

Prices refer to our image bank and those sent in by the customer.

129813-	W. 600	H. 600	D. 50	644,89
129814-	W. 1200	H. 600	D. 50	689,15
129815-	W. 1200	H. 900	D. 50	832,23
129816-	W. 1200	H. 1200	D. 50	955,74
129817-	W. 1600	H. 1200	D. 50	1215,74
129818-	W. 2400*	H. 1200	D. 50	1531,70

### ORDER PRINT ECOSUND WITH CONCEALED FRAME

1. Choose format
2. Choose image
3. Choose length of mounting strip

Quotes are offered for Print with photographs and art by the artists Gotessons collaborate with, and images Gotessons buys.

### Mounting strip Dikt for frame

List for wall mount.

346000	320 mm (for print/absorbent 600 mm)	12.13
349000	620 mm (for print/absorbent 900 mm)	13.09
341200	920 mm (for print/absorbent 1200 mm)	14.04
341600	1320 mm (for print/absorbent 1600 mm)	17.87
342400	2120 mm (for print/absorbent 2400 mm)	26.49

\*For orders of W. 2400 mm, minimum quantity: 5 pcs. For quantity less then 5 pcs, we recommend Big Print.

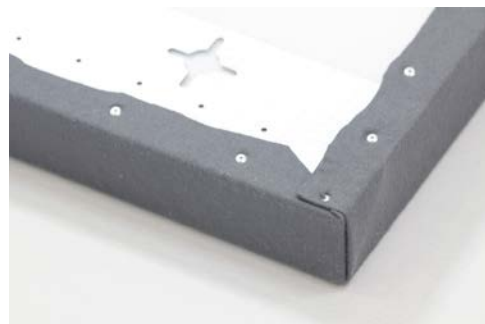



Big Print is more than an acoustic solution for your environment, it is an acoustic element that sets the tone in the whole room. Use your own or a bought illustration/photo to suit your interior. Big Print can be ordered in large as well as small formats with the benefit that a new printed canvas is all you need to order if you in the future want to change the image. The aluminium frame and EcoSUND absorbents remain in place.



## BIG PRINT ECOSUND®

### Big Print EcoSUND

Thickness: 40 mm.

121250-

Contact us for price

### ORDER BIG PRINT

Contact us for a quote. Picture choice: Choose pictures from our image bank or send in your own. Gotessons can also help you purchase images from an image bank.

Mounting: Big Print is delivered in parts. In any measurements up to 3 x 50 m, Big Print can be delivered in one piece without a splice. For bigger measurements, the print is made on several canvases. The aluminum profiles that make up the frame are mounted in straight angles on the wall and sound absorbents are attached with Hook & Loop tape directly onto the underlying wall. Wrap the printed canvas over the absorbent and insert the attached rubber strip into the groove of the aluminum profile to hold the canvas in place.



Nivå improves acoustics and its design makes it a feature in any room. The panels can be varied to form different patterns in different colours, with or without textile. Our core material is available in four colours, and can be dressed in with several different textiles, your wall becomes almost unique. The thickness of the absorber varies over the surface from 30-90 mm in the cut rectangular and square patterns.



Fix the acoustics with smart sound absorbent Effekt EcoSUND Ceiling/Wall with clamps. For a discrete sound absorbing system in the ceiling or on the wall, two clamps per panel is mounted, the panel is slid inside the clamps and improves the sound environment immediately. Choose Effekt Ceiling/Wall in raw EcoSUND in colour white, black, grey or bronze brown. To match the rest of your interior, dress the panels in textile Hush.

## NIVÅ ECOSUND® WALL PANEL

### Nivå EcoSUND wall panel

125593-	W. 593	H. 593	raw	98,40
125594-	W. 593	H. 593	dressed	141,28

### HOW TO ORDER NIVÅ ECOSUND RAW

Art.No - Colour core.

Example: 125593-2 = Nivå EcoSUND with black core.

### HOW TO ORDER NIVÅ ECOSUND WITH HUSH

Art.No - Colour textile - Edge colour (core).

Example: 125594-567-1 = Nivå EcoSUND with blue Hush and white edge (core).

Facts: Nivå dressed can only be ordered in Hush textile. See textiles and core material in the textile chapter.

Colour code core material: white-1 black-2 grey-3 light grey-6

## EFFEKT ECOSUND® CEILING/WALL

### Effekt EcoSUND ceiling/wall

125130-	W. 1200	H. 600	D. 50	raw	88,30
125131-	W. 1200	H. 600	D. 50	dressed	153,19
125132-	W. 1200	H. 900	D. 50	raw	131,60
125133-	W. 1200	H. 900	D. 50	dressed	191,28

### ORDER EFFEKT CEILING/WALL RAW:

Art.no - core material

Example: 125130-2 = Effekt EcoSUND in black

### ORDER EFFEKT CEILING/WALL DRESSED IN HUSH

Art.no - Colour of textile - Colour of edge (core material/raw) Example:

125131-567-1 = Effekt EcoSUND dressed in blue Hush and white edge (core material/raw)

Each panel is mounted with 2 clamps (not included). Dressed Effekt can only be ordered in textile Hush.

See page 6-14 for textile and core material.

Colour code core material: white-1 black-2 grey-3 light grey-6

### Clamp 600 mm for Effekt EcoSUND ceiling/wall

Low clamp lies tight against the Effekt Ceiling/Wall EcoSUND.

W. 600 H. 56 D. 30

643090-1 white -2 black -3 silver 19.04/2pcs

### Clamp 900 mm for Effekt EcoSUND ceiling/wall

Low clamp lies tight against the Effekt Ceiling/Wall EcoSUND.

W. 900 H. 56 D. 30

643091-1 white -2 black -3 silver 27.77/2pcs

### Clamp air gap 600 mm for Effekt EcoSUND ceiling/wall

High clamp for 50 mm air gap behind the absorbent.

W. 600 H. 107 D. 30

643092-1 white -2 black -3 silver 26.49/2pcs

### Clamp air gap 900 mm for Effekt EcoSUND ceiling/wall

High clamp for 50 mm air gap behind the absorbent.

W. 900 H. 107 D. 30

643093-1 white -2 black -3 silver 30.11/2pcs

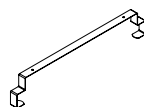
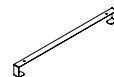



Sound absorbing 3D letters for hanging on the wall with Hook & Loop tape consisting of recycled polyester foam and dressed with Hush. Contact Gotessons for more information regarding other signs and sizes, etc. Sound Off letters can only be ordered with Hush. The edge will be raw.



Tell-Us improves the acoustics and enhances the interior design with its 3D effect. The sound absorbent is made of our unique core material EcoSUND. Tell-Us is as standard available with a grey, black or white frame and can be ordered with textile Hush. The textile is selected for its ability to allow the sound pass through to the acoustic panel to achieve maximum sound absorption.

## SOUND OFF ECOSUND® LETTERS

### Sound Off EcoSUND letters

The standard letter type is Arial Black. The standard height is 350 mm and thickness 50 mm. With Hook & Loop tape that is hammered or stapled to the wall.

120110-	H. 350	raw	55,00
120100-	H. 350	dressed	79,79

### HOW TO ORDER LETTERS RAW:

Art.no - Type of letter / digit / character - Colour core.  
Example: 120110-E-3 = Letter E in grey.

### HOW TO ORDER LETTERS WITH HUSH:

Art.no - Type of letter / digit / character - Colour of textile - Colour core.  
Example: 120100-E-569-1 = Letter E dressed with green Hush and white edge (core).

---

See textiles and core material in the textile chapter.

---

Colour code core material: white-1 black-2 grey-3 light grey-6

---

## TELL-US ACOUSTIC WORLD MAP



### Tell-Us EcoSUND

160120-	W. 1600	H. 1200	D. 50	763,62
240120-	W. 2400	H. 1200	D. 50	1080,43

### HOW TO ORDER TELL-US

Art.No - Colour frame - Colour textile - Edge colour (core).  
Example: 160120-1-567-1 = Tell-Us with white frame in blue Hush and white edge. (core).



### Mounting strip Dikt for frame 1600 mm

List for wall mount.

341600	1320 mm (for print/absorbent 1600 mm)	17.87
--------	---------------------------------------	-------

### Mounting strip Dikt for frame 2400 mm

List for wall mount.

342400	2120 mm (for print/absorbent 2400 mm)	26.49
--------	---------------------------------------	-------

Important info: Tell-Us can only be ordered in Hush textile. See textiles and core material in textile chapter. The edge will be raw.  
For orders of W. 2400 mm, minimum quantity: 5 pcs.

---

Colour code core material: white-1 black-2 grey-3 light grey-6

---



The screen can be used as a desk, floor and wall screen. This screen is without holes and can be ordered with height adjustable mounting brackets. The screen can then easily be moved up and down with an Allen key. See video on [www.gotessons.com](http://www.gotessons.com).



Collage is a two-in-one solution combining good acoustics with a practical notice board. Collage is manufactured in six standard formats. All absorbents are 50 mm thick for good sound absorption and made of our unique core material EcoSUND. Choose colour from textiles Acoustic Nonwoven, Hush or Blazer Lite to match the rest of your furniture.



## SCREENIT A30 FLEXIBLE

### ScreenIT A30 Flexible 650 mm, zipper on long side

See price ranges in textile chapter.

			Pricer. 1	Pricer. 2	Pricer. 3	Pricer. 4
<b>With seam</b>						
627080-	W. 800	H. 650	183,40	192,77	338,83	443,30
627120-	W. 1200	H. 650	245,85	276,91	398,83	505,74
627140-	W. 1400	H. 650	252,98	289,36	405,74	512,87
627160-	W. 1600	H. 650	255,96	302,02	408,62	515,74
627180-	W. 1800	H. 650	292,77	347,77	444,04	552,98
627200-	W. 2000	H. 650	374,26	406,28	522,02	633,83
<b>With zip</b>						
627080-	W. 800	H. 650	227,02	236,81	380,53	486,81
627120-	W. 1200	H. 650	289,36	320,96	440,64	549,15
627140-	W. 1400	H. 650	296,60	333,40	447,45	556,49
627160-	W. 1600	H. 650	299,47	346,06	450,32	559,26
627180-	W. 1800	H. 650	336,60	391,81	486,06	596,60
627200-	W. 2000	H. 650	417,55	450,43	550,43	677,45

### ScreenIT A30 Flexible 800 mm, zipper on long side

			Pricer. 1	Pricer. 2	Pricer. 3	Pricer. 4
<b>With seam</b>						
625080-	W. 800	H. 800	253,83	267,23	448,51	667,02
625120-	W. 1200	H. 800	316,17	330,00	535,64	702,66
625140-	W. 1400	H. 800	323,40	364,15	632,45	802,13
625160-	W. 1600	H. 800	326,28	397,77	692,87	873,30
625180-	W. 1800	H. 800	363,30	435,32	770,74	944,68
625200-	W. 2000	H. 800	444,47	471,38	825,53	1072,77
<b>With zip</b>						
625080-	W. 800	H. 800	297,45	311,06	490,43	710,43
625120-	W. 1200	H. 800	359,57	373,83	577,34	746,28
625140-	W. 1400	H. 800	366,91	408,09	674,26	845,64
625160-	W. 1600	H. 800	369,89	441,60	734,68	917,02
625180-	W. 1800	H. 800	406,91	479,26	812,66	988,19
625200-	W. 2000	H. 800	487,98	515,43	867,23	1116,28

#### How to order:

1. Select screen size.
2. Select screen colour (see colours on page 6-16).
3. Select zip or seam colour (see colours on page 17).
4. Select Wall package.

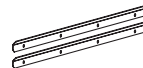

#### Wall package

List for wall mount.

641063	500 mm	22.66
641064	1000 mm (for screens longer than 1800 mm)	42.77

## COLLAGE CONCEALED FRAME

			Hush	Blazer Lite
<b>Collage concealed frame</b>				
125706-	W. 600	H. 600	339,68	360,00
125707-	W. 1200	H. 600	371,06	390,85
125708-	W. 1200	H. 900	411,81	458,62
125709-	W. 1200	H. 1200	547,34	607,77
125710-	W. 1600	H. 1200	684,89	730,64
125711-	W. 2400	H. 1200	816,60	901,49

#### How to order:

Art.no - Textile.

Example: 125708-567 = Collage with concealed frame dressed with blue Hush.

Facts: Can be ordered in textiles Hush and Blazer Lite. Also possible to dress in other textiles upon request. See textiles in the textile chapter. For orders of W. 2400 mm, minimum quantity: 5 pcs.

## COLLAGE ECOSUND®

### Collage EcoSUND with frame in white, black, grey

			Acoustic Nonwoven	Hush	Blazer Lite
125700-	W. 600	H. 600	193,40	291,81	332,77
125701-	W. 1200	H. 600	216,06	318,40	375,96
125702-	W. 1200	H. 900	260,21	354,04	419,04
125703-	W. 1200	H. 1200	265,85	386,91	481,81
125704-	W. 1600	H. 1200	348,94	477,23	557,45
125705-	W. 2400	H. 1200	721,60	810,32	893,62

### Collage EcoSUND with frame in oak, walnut

			Hush	Blazer Lite
125730-	W. 1200	H. 1200	712,23	850,53
125731-	W. 1600	H. 1200	903,72	1010,11

See colour frame in the textile chapter.

#### How to order:

Art.No - Colour frame - Colour fabric/Acoustic Nonwoven. Example:

125702-1-567= Collage with white frame in blue Hush.

#### Mounting strip Dikt for frame

List for wall mount.

346000	320 mm (for print/absorbent 600 mm)	12.13
349000	620 mm (for print/absorbent 900 mm)	13.09
341200	920 mm (for print/absorbent 1200 mm)	14.04
341600	1320 mm (for print/absorbent 1600 mm)	17.87
342400	2120 mm (for print/absorbent 2400 mm)	26.49





## OFF THE GRID WALL

### Off the Grid wall

Off The Grid is only the metal frame with hanging clips for wall included.  
Suits Off the grid absorbent. Inner dimension depth 52 mm.

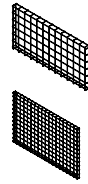

644100-2	W. 1200	H. 600	D. 62	black	180,21
644100-3	W. 1200	H. 600	D. 62	silver	180,21
644100-20	W. 1200	H. 600	D. 62	brass	190,11
644101-2	W. 1800	H. 1200	D. 62	black	289,79
644101-3	W. 1800	H. 1200	D. 62	silver	289,79
644101-20	W. 1800	H. 1200	D. 62	brass	300,74

### Off the Grid absorbent

Absorbents in EcoSUND adapted for Off the Grid wire mesh. Fits both the model for the ceiling and for the wall.

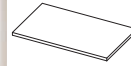

126120-	W. 1200	H. 600	D. 50	raw	76,17
126121-	W. 1200	H. 600	D. 50	dressed	120,00
126122-	W. 1800	H. 1200	D. 50	raw	278,83
126123-	W. 1800	H. 1200	D. 50	dressed	377,45

Off The Grid is a wire frame for wall mounting. Combine with Off the grid absorbent in coated or raw EcoSUND alternatively with Tiles EcoSUND. Add plant garlands to give the room an eye-catching detail.

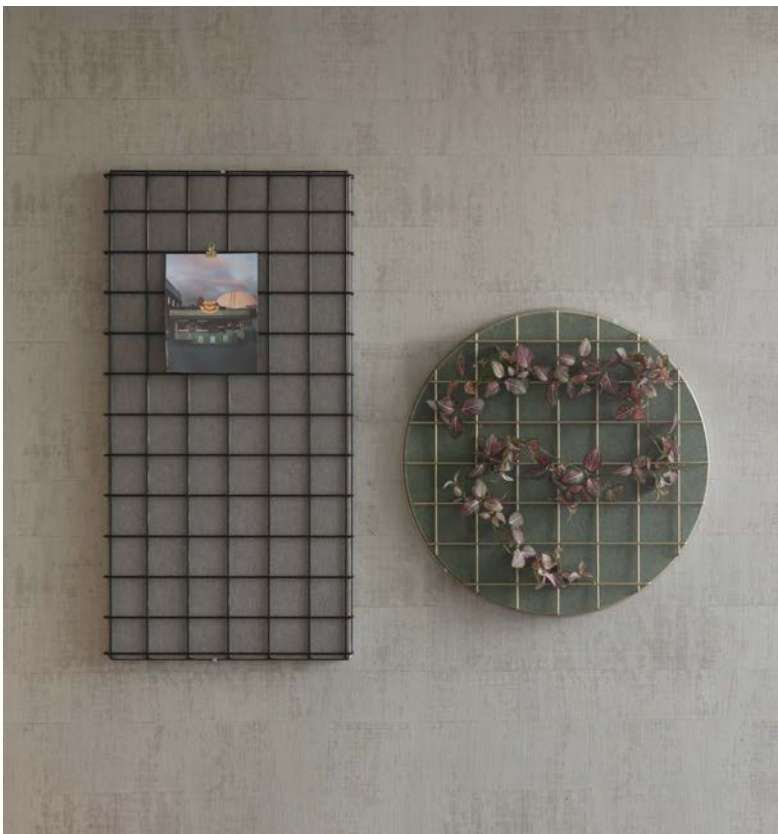

### Off the Grid wall circle

Off The Grid is only the wire grid with hanging clips for wall mounting.  
With space for Off the Grid absorbent. Inner dimension depth 52 mm.

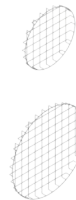

644102-2	Ø 772	D. 62	black	180,21
644102-3	Ø 772	D. 62	silver	180,21
644102-20	Ø 772	D. 62	brass	190,11
644104-2	Ø 1102	D. 62	black	213,09
644104-3	Ø 1102	D. 62	silver	213,09
644104-20	Ø 1102	D. 62	brass	222,98

### Off The Grid Absorbent EcoSUND circle

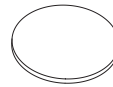

126124-	Ø 750	D. 50	raw	109,04
126125-	Ø 750	D. 50	dressed	174,79
126126-	Ø 1080	D. 50	raw	152,87
126127-	Ø 1080	D. 50	dressed	229,57

Choose Tiles Raw EcoSUND in white, black or grey or dressed in Hush.  
See colours in textile chapter.



RUM 228

ROSA

DIM 220

ROSA

LÄNGLIVAT

Johannesson



# STORAGE

Create order with smart storage units with sound absorbing qualities. Thanks to smartdesign such as cable management, place for the TV, writing board and electric sockets, the needs are met for many types of spaces. Create zones and rooms within the room, move around thanks to the mounted wheels or build a meeting point with the storage at its center. Creative spaces see the possibilities!



## SCREENIT WARDROBE

Sound absorbing booth for hanging clothes. Perfect for the modern office or for other public spaces. Built with A30 floor screens and clothes rail Ø 25 in black or white lacquered metal.



## SCREENIT WARDROBE

### ScreenIT Wardrobe

Constructed with wooden frame, 30 mm sound absorber and 5 mm foam laminated textile. Total thickness 40 mm. Straight corners, radius 10. Adjustable feet. Size assembled 1280x1800 mm.

W. 1280 H. 1800 D. 640

See price ranges on page 6-16.

1190180-	Pricer. 1 1760,64	Pricer. 2 1892,66	Pricer. 3 2122,34	Pricer. 4 2705,11
----------	----------------------	----------------------	----------------------	----------------------

### Clothes rail for ScreenIT Wardrobe

Clothes rail in Ø 25 metal pipe including bracket in 4 mm sheet metal.

Maximum load 25 kg.

L. 1192

648050-1	white	140.21
648050-2	black	140.21

### How to order ScreenIT Wardrobe:

1. Art. no - textile (see textiles on page 10-16).

Example: ScreenIT Wardrobe - Tonal 126 1190180 - 126 (seam like textile).

2. Order clothes rail, choose colour.

## SIGN

Of course should a hanger look good! After all, the hanger is not always hidden under jackets, coats or other outdoor. Sign is the hanger with soft forms that suits well to Hang in There/ScreenIT Wardrobe.

### Sign Hanger

Powder coated in metal with soft forms. Delivered in 4-pack.

W. 420 H. 215 D. 7

891072-1	white	81.60
891072-2	black	81.60

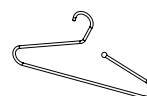
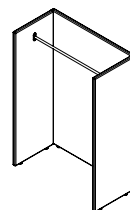



## HANG IN THERE

Hang In There is a minimalistic clothes rail with knobs and room for hangers. The design allows it to fit in at offices as well as school and lobbies. For more room to hang items, two Hang In There can be mounted together with an extension rod.

### Hang In There

Material: powder coated steel.  
L. 1000 W. 450 H. 1625 D. 600

891070-1	white	481.17
891070-2	black	481.17

### Hang In There, extension rod

Connects 2 pcs Hang In There. Material: powder coated steel.  
Max load: 25 kg. L. 1000

891071-1	white	47.45
891071-2	black	47.45

Can be ordered in other colours, contact Götessons for a quote.

## SIGN

Of course should a hanger look good! After all, the hanger is not always hidden under jackets, coats or other outwear. Sign is the hanger with soft forms that suits well to Hang in There/ScreenIT Wardrobe.

### Sign Hanger

Powder coated in metal with soft forms. Delivered in 4-pack.  
W. 420 H. 215 D. 7

891072-1	white	81.60
891072-2	black	81.60

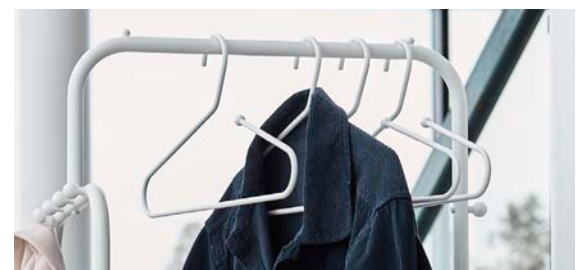



## MOVING WALL TOWER

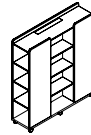

### Moving Wall Tower

Wooden details in laminate.  
W. 1650 H. 1800 D. 450

See price ranges in the textile chapter.

	Pricer. 1	Pricer. 2	Pricer. 3	Pricer. 4
110020- ash	4010,96	4559,26	5231,91	5815,64
110021- oak	4010,96	4559,26	5231,91	5815,64
110022- walnut	4010,96	4559,26	5231,91	5815,64
110023- white	4010,96	4559,26	5231,91	5815,64

Important info: measurements incl. wheels. The product is, in its basic design, assembled at delivery. Holes for cables in the bottom.

Moving Wall Tower is the tallest of the three versions and built with A30 screens for good noise absorption. The furniture is easily moved thanks to braking and lockable wheels. Tower has shelves on both short sides and in the middle of one long side - excellent for storage and design. On the top shelf in each end there is a cable grommet to draw cables inside the furniture, these can be exchanged for Power Grommet for easy access to electricity. There is an opening with a lid on top for access inside Tower. Tower, Bridge and Media are great in combination with each other.



## MOVING WALL BRIDGE

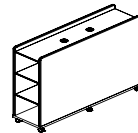

### Moving Wall Bridge

Wooden details in laminate.  
W. 1650 H. 1400 D. 450

See price ranges in the textile chapter.

	Pricer. 1	Pricer. 2	Pricer. 3	Pricer. 4
110010- ash	3170,43	3789,36	4677,34	5268,72
110011- oak	3170,43	3789,36	4677,34	5268,72
110012- walnut	3170,43	3789,36	4677,34	5268,72
110013- white	3170,43	3789,36	4677,34	5268,72

Important info: measurements incl. wheels. The product is, in its basic design, assembled at delivery. Holes for cables in the bottom.

See information about the laminates in the textile chapter.

Power Grommet Twist that can be mounted in the product, see chapter Electrical Accessories: art.no 700532-1, -2, -3 / 702532-1, -2, -3 / 700332.

#### HOW TO ORDER MOVING WALL TOWER/BRIDGE:

Art. no - textile.

Example: Moving Wall Tower - Bond 755 110020 - 755 (seam like textile).

Bridge is one of three models in the series Moving Wall. It's a room divider on lockable wheels. The furniture is built with A30 screens and therefore an excellent sound absorbent. On the top, 2 pcs cable grommets are mounted for cables to be easily drawn inside the furniture. If needed, Power Grommet can be mounted instead.



Media is one out of three room dividers and storage units in the Moving Wall series. It has shelves on the short sides and in two sections on the front, hidden behind sliding doors with a lock. The front it also prepared for mounting a TV and the back for a Sketch Writing board, see Sketch in the Whiteboard chapter. Built with A30 screens, Media is also a great sound absorbent and a flexible interior element thanks to braking and lockable wheels. 2 pcs cable grommets are mounted on top and 1 pc in the center where the TV is mounted in order for cables to easily be hidden.

## MOVING WALL MEDIA

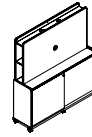

### Moving Wall Media

Reinforced screen for mounting of TV screen. Wooden details in laminate. Max width TV: 65". Max weight TV: 35 kg.

W. 1650 H. 1800 D. 450

See price ranges in the textile chapter.

	Pricer. 1	Pricer. 2	Pricer. 3	Pricer. 4
110030- ash	5693,72	6346,81	7229,36	7605,64
110031- oak	5693,72	6346,81	7229,36	7605,64
110032- walnut	5693,72	6346,81	7229,36	7605,64
110033- white	5693,72	6346,81	7229,36	7605,64

Important info: measurements incl. wheels. The product is, in its basic design, assembled at delivery. Holes for cables in the bottom.

See information about the laminates in the textile chapter.

### HOW TO ORDER MOVING WALL MEDIA:

Art. no - textile.

Example: Moving Wall Media - Bond 755 110030 - 755  
(seam like textile)

### TV mount Moving Wall Media

Bracket in metal. 2 mounts included.

610611	black	108.40
--------	-------	--------

### Sketch writing board floor screen

Writing board in glass to mount on floor screen and Moving Wall Media. Screws included. Glass 4 mm. Designed for screen 1600 mm.

101016	W. 1590 H. 990 D. 4	white	1038.94
101016-1	W. 1590 H. 990 D. 4	sand	1139.47
101016-2	W. 1590 H. 990 D. 4	mist	1139.47
101016-3	W. 1590 H. 990 D. 4	olive	1139.47
101016-4	W. 1590 H. 990 D. 4	ocean	1139.47
101016-5	W. 1590 H. 990 D. 4	rhubarb	1139.47
101016-6	W. 1590 H. 990 D. 4	lilac	1139.47
101016-7	W. 1590 H. 990 D. 4	harvest	1139.47





## TEXTILE BOX

Textile box in light grey that fits the Moving Wall storage system, but works just as well independently.

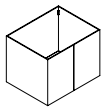

### Textile box

Material: fiberboard. Dressed with Hush light grey 60155.  
Delivered as a flat pack.  
W. 365 H. 500 D. 460

110044 light grey 189.36



## BOX UNIT FOR MOVING WALL

This box unit with a lockable door are a practical and stylish contribution to Moving Wall Bridge and Moving Wall Tower. Choose between the laminates in white, oak or walnut.

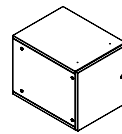

### Box unit for Moving Wall

Material: Wood details in laminate. Equipped with lock and adjustable hinges. Can be obtained both right- and left-handed. Two keys included. Mounted separately. Not suitable for Moving wall Media.

110040	ash	384.79
110041	white	384.79
110042	oak	384.79
110043	walnut	384.79

Out. meas: W. 383 H. 385 D. 496.

In. meas: W. 347 H. 349 D. 478.

See information about the laminates in the textile chapter.



## BRINGIT LAPTOP BAG

BringIT is a storage bag in black felt material with practical compartments for your laptop, folders and personal belongings. The bag is perfect for the activity-based office, you can easily transport all your belongings in a smooth way. Carry the computer with you in the bag to the meeting room, office or hang it at the workplace on a hook, purchased separately. Made from 100 % recyclable polyester.

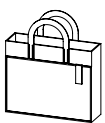

### BringIT Laptop Bag

Laptop bag in felt material with compartment on the outside, one divider in the middle on the inside and 2 compartments inside.  
W. 380 H. 310 D. 110

640086 black 145.43

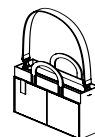

### BringIT + storage bag

Laptop bag in felt material with compartment on the outside, one divider in the middle on the inside and two compartments inside. Shoulder strap and two handles. With zipper.

W. 380 H. 310 D. 110

640087 black 172.55



### Hook with screws

Hook to be mounted under the desk. Screws included.  
W. 40 H. 53 D. 58

671088-1	white	14.89
671088-2	black	14.89
671088-3	silver	14.89



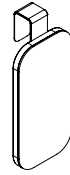

**Look**

Only fits ScreenIT A30 screens. Lacquer and MDF are always white. Leather is always light beige, material: IMOLA. \*

637127	white, brown leather	151.91
637132-1	white	118.51

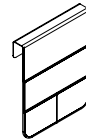

**Pocket**

Only fits ScreenIT A30 screens. 2 smaller pockets, 1 larger pocket. Leather is always light beige; material: IMOLA. \*

637126	brown leather	125.32
--------	---------------	--------

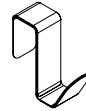
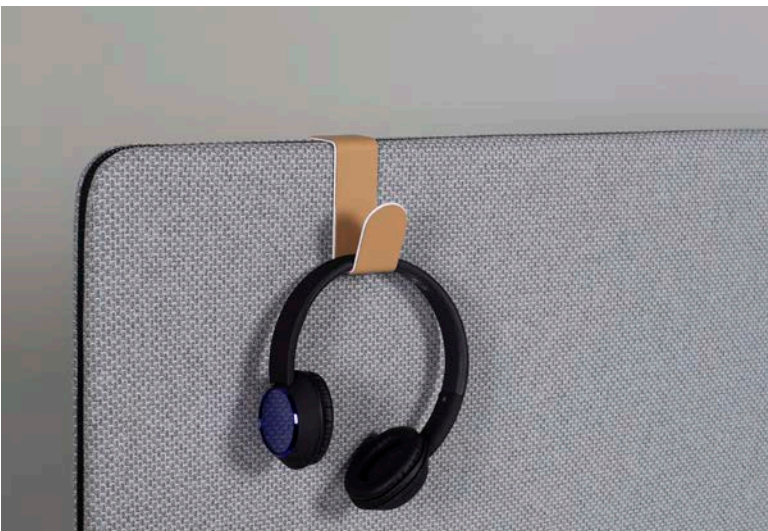

**Hook**

Only fits A30 screens. Lacquer is always white. Leather is always light beige, material: IMOLA. \*

637129	white, brown leather	52.45
637134-1	white	20.53

\*Imola= 50 % polyester, 30 % bomull, 20 % resirkulert skinn.





## TABLES

**R**ound or rectangular, large or small. Or why not foldable? Adapt the table to the interior and needs and not the other way around. Here is the new No Pocket Table and our round table Sit Around together with the transforming furniture iQseat where the backrest is easily transformed into a small work table.

## SOFT SEATING

**S**oft seating stools at the office that act as an extra seat for visitors and used for private storage. Comfortable sofas with high backrests creating sheltered privacy, a place to meet or retreat. Soft lounge furniture for a short nap to quickly get some new energy for the next meeting. Seating for all kind of environments where you can design and build your own creative space.



## SANDY SOFA

The Sandy family is growing with new seat modules and accessories. For a more comfortable sitting comfort, there is a module with backrest. The former round seat puffs are joined by straight modules like Sandy annex. Create your own unique combinations by putting together center sections and outer sections. They can be placed freely or with one edge against a wall. Design: JOOY Design Studio.



Sandy backrest comes pre-assembled and is connected to other accessories through magnetic coupling. Easy mounting, no tools are needed.

## SANDY SOFA

Constructed of MDF, covered with foam and textile.  
Base in oak, ash, walnut, black or white laminate.

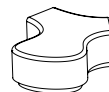

### Sandy middle section

Mounted with magnets.

W. 1450 H. 460 D. 1260  
647620-

Pricer. 1	Pricer. 2	Pricer. 3	Pricer. 4
1595,21	1648,40	1754,79	1967,55

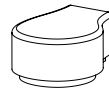

### Sandy outer section

Mounted with magnets.

W. 990 H. 460 D. 785  
647621-

105,85	1116,49	1222,87	1329,26
--------	---------	---------	---------



### Sandy Sofa with pouf

A complete sofa with 1x middle section, 2 x outer sections and 1 x pouf.  
All sections in the same textile and the same laminate.

The sofa is assembled with magnets.

W. 1450 H. 460 D. 1260  
647623-

3988,83	4201,60	4520,74	4839,89
---------	---------	---------	---------



### Sandy backrest

Outer section with backrest.

W. 990 H. 820 D. 785  
647608-

1754,79	1807,98	1914,36	1967,55
---------	---------	---------	---------

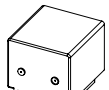

### Sandy annex

Module with magnets on both sides.

W. 500 H. 460 D. 470  
647607-

8195,00	8795,00	9795,00	10795,00
---------	---------	---------	----------

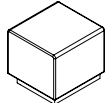

### Sandy annex edge

Module with magnets on one side only.

W. 500 H. 460 D. 470  
647609-

882,45	946,28	1052,66	1159,04
--------	--------	---------	---------

### How to order Sandy backrest:

1: Choose textile for backrest section.

Example: 647608-316 (Era, Calendar CSE19), Color of textile = color of seam

2: Select color of laminate.

Example: 647608-316-911 (oak laminate).

### How to order Sandy annex:

1: Choose textile for the annex section.

Example: 647607-350 (Noble lux, 608 light beige), Color of textile = color of seam

2: Select color of laminate. Example: 647607-350-911 (oak laminate).



## SANDY SOLUS

Sandy Solus is a freestanding seating furniture with two connected crescent-shaped seats and a central backrest. It's the perfect lounge solution for waiting rooms, entrances, and other public spaces.



## SANDY SOLUS

Constructed of MDF, covered with foam and textile.  
Base in oak, ash, walnut, black or white laminate.



### Sandy Solus

Sandy Solus, a circular sofa with backrest for a moment of social interaction.  
W. 1450 H. 460 D. 1260

	Pricer. 1	Pricer. 2	Pricer. 3	Pricer. 4
647604-	3084,57	3297,34	3510,11	3722,87

Prices apply to colours in the textile chapter. Textiles that can be selected:

Pricer. 1: Event Screen +, Houston Reflect, Mica, Omega, Pearl, Slope, Tonal  
Pricer. 2: Era, Kaiman, Lido, Noble lux, Rivet  
Pricer. 3: Ally, Blazer, Bond, Synergy  
Pricer. 4: Illusion II, Remix 3

### Laminate

911 oak  
912 walnut  
913 white  
914 black  
915 ash

For more information on laminates, see the textile chapter.

### How to order Solus:

1: Select the Solus section.  
Example: 647604-350 (Noble lux, 608 Light beige)

2: Choose color of laminate.  
Example: 647604-350-911 (oak laminate).

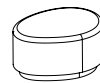

### Sandy pouf

W. 945 H. 460 D. 745

647602-	888,09	898,94	943,94	1167,34
---------	--------	--------	--------	---------





## SANDY TABLE

Sandy table designed by JOOY Design studio. Fits perfectly with the Sandy sofa but also with other seating furniture. The asymmetrical, oval and modern shape makes the table the obvious choice in the lounge.



## SANDY TABLE



### Sandy table

Table top with laminate.

Metal stand in black or white.

Both bottom plate and table top in the same shape.

W. 740 H. 560 D. 940

647610-1	ash/white	776.38
647610-2	ash/black	776.38
647611-1	white/white	776.38
647611-2	white/black	776.38
647612-1	oak/white	776.38
647612-2	oak/black	776.38
647613-1	walnut/white	776.38
647613-2	walnut/black	776.38
647614-1	black/white	776.38
647614-2	black/black	776.38



ash



white



oak

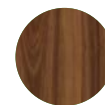

walnut



black



## ROMBOWORK

With RomboWork you get another function to the smart and useful Rombo series of seating furniture and pots. An easily accessible workspace that can be moved around, if you choose RomboWork on wheels. Place in groups of three with their backs to each other. Designed by Henrik Kjellberg and Jon Lindström from o4i Design Studio.



## ROMBOWORK

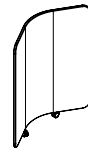

### RomboWork screen

Contents: screen with wheels.  
W. 1000 H. 1160 D. 250

	Pricer. 1	Pricer. 2	Pricer. 3	Pricer. 4
647350-	738,83	792,02	850,53	956,91



### RomboWork table

Contents: table top in laminate. The table top is lacquered on the underside and edge in the same color as the base. Metal base.  
W. 990 H. 720 D. 500

647360-1	ash/white	652.87
647360-2	ash/black	652.87
647361-1	oak/white	652.87
647361-2	oak/black	652.87
647362-1	walnut/white	652.87
647362-2	walnut/black	652.87
647363-1	white/white	569.15
647363-2	white/black	569.15
647364-1	black/white	569.15
647364-2	black/black	569.15

For more information on laminates, see the textile chapter.

### How to order RomboWork:

1: Choose textile and seam for RomboWork Screen.  
Example: 647350-470-206.

2: Choose colour at RomboWork Table.  
Example: 647364-1.

RomboWork is assembled by the customer.





## ROMBOPLANTER

RomboPlanter is a textile-covered pot that can be filled with plants. Available in two different heights for the possibility of nice arrangements.  
Designed by Henrik Kjellberg and Jon Lindström from o4i Design Studio.



## ROMBOPLANTER

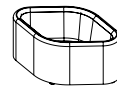

**RomboPlanter 450 mm**  
W. 1000 H. 450 D. 650

647175-	Pricer. 1 1063,30	Pricer. 2 1116,49	Pricer. 3 1169,68	Pricer. 4 1222,87
---------	----------------------	----------------------	----------------------	----------------------

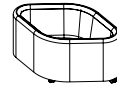

**RomboPlanter 475 mm with wheels**

647176- with wheels	1169,68	1222,87	1276,06	1329,26
---------------------	---------	---------	---------	---------

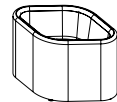

**RomboPlanter 650 mm**  
W. 1000 H. 650 D. 650

647177-	1329,26	1382,45	1435,64	1488,83
---------	---------	---------	---------	---------



**RomboPlanter 675 mm with wheels**

647178- with wheels	1435,64	1488,83	1542,02	1595,21
---------------------	---------	---------	---------	---------

### Important information:

RomboPlanter is made up of: MDF, covered with foam and textile.  
Waterproof pot included.  
The wheels are always black, lockable.

### Specify the article number as follow:

RomboPlanter - Colour of textile (Seam will be similar to textile colour).



## ROMBOSEAT

A stylish furniture that makes it easy to decorate thanks to its unique shape. Seating that can be ordered free standing, with table, with screen or with table and screen. Dress with optional textile for seating furniture. Tables and screens are ordered in separate article numbers. Designed by Henrik Kjellberg and Jon Lindström from o4i Design Studio.



## ROMBOSEAT WITH WHEELS

A stylish portable seating furniture that makes it easy to decorate thanks to its unique shape. With RomboSeat with lockable wheels you can create flexible sitting areas that can be moved around. The seating furniture can be ordered: freestanding, with table, screen or with both table and screen. Designed by Henrik Kjellberg and Jon Lindström from o4i Design Studio.

## ROMBOSEAT

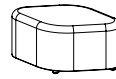

### RomboSeat free seating

*Includes: RomboSeat*  
W. 1000 H. 450 D. 650  
647160-

Pricer. 1	Pricer. 2	Pricer. 3	Pricer. 4
820,43	902,55	926,06	978,72

### RomboSeat to RomboTable

*Includes: RomboSeat adapted with hole pattern for RomboTable.*  
W. 1000 H. 450 D. 650  
647161-

820,43	902,55	926,06	978,72
--------	--------	--------	--------

### RomboSeat to RomboTable & RomboScreen

*Includes: RomboSeat adapted with hole pattern for RomboTable and RomboScreen.*  
W. 1000 H. 450 D. 650  
647162-

820,43	902,55	926,06	978,72
--------	--------	--------	--------

## ROMBOSEAT WITH WHEELS

### RomboSeat with wheels

*Includes: RomboSeat with lockable wheels.*  
W. 1000 H. 475 D. 650  
647165-

Pricer. 1	Pricer. 2	Pricer. 3	Pricer. 4
932,13	1014,26	1037,77	1090,43



### RomboSeat with wheels to RomboTable

*Includes: RomboSeat with lockable wheels, adapted with hole pattern for RomboTable.*  
W. 1000 H. 475 D. 650  
647166-

932,13	1014,26	1037,77	1090,43
--------	---------	---------	---------

### RomboSeat with wheels to RomboTable & RomboScreen

*Includes: RomboSeat with lockable wheels adapted with hole pattern for RomboTable and RomboScreen.*  
W. 1000 H. 475 D. 650  
647167-

932,13	1014,26	1037,77	1090,43
--------	---------	---------	---------

### RomboScreen

*Includes: RomboScreen.*  
W. 1000 H. 1130 D. 250  
647163-

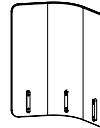

703,20	773,52	837,98	937,77
--------	--------	--------	--------

### RomboTable

*Includes RomboTable, turnable. Base in metal and table top in laminate. The table is rotatable. Height from floor: 700 mm. Measure table: 450x300 mm.*

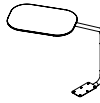

647180-1	ash/white	457.45
647180-2	ash/black	457.45
647181-1	oak/white	457.45
647181-2	oak/black	457.45
647182-1	walnut/white	457.45
647182-2	walnut/black	457.45
647183-1	white/white	435.11
647183-2	white/black	435.11
647184-1	black/white	435.11
647184-2	black/black	435.11

### Important information:

RomboSeat is made of: MDF, pinewood, foam seat (plastic).

RomboScreen is made of: Plywood, textile, laminate.

RomboTable is made of: Metal, MDF, laminate.

The wheels are always black, lockable.

See information about the laminates in the textile chapter.

### Prices apply to colours in the textile chapter. Textiles that can be selected:

Pricer. 1: Event Screen +, Houston Reflect, Mica, Omega, Pearl, Slope, Tonal  
Pricer. 2: Era, Kaiman, Lido, Noble lux, Rivet  
Pricer. 3: Ally, Blazer, Bond, Synergy  
Pricer. 4: Illusion II, Remix 3

### Order procedure for RomboSeat:

1: Choose textile for RomboSeat .

Ex: 647167-517-206.Colour textile = colour on seam.

2: Choose textile for RomboScreen .

Ex: 647163-519-206. Colour textile = colour on seam.

3: Choose colour for RomboTable Ex: 647180-2.



## ROMBOSEAT WITH SOCKET

Romboseat is also available equipped with electricity.  
Max Power Grommet is put into the seat for easy charging.



## ROMBOBACKREST

Backrest is a custom-made cushion for Romboseat for better seating comfort. Match with the sofa's textile or choose a different color scale.

## ROMBOSEAT WITH SOCKET

Romboseat equipped with Max Power Grommet 721503, 1 extension, USB A+C. Other equipment can be ordered as special. 1.5 meter cable included.

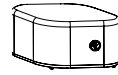

### Romboseat incl. Max Power Grommet

Including: RomboSeat.

	W. 1000	H. 450	D. 650	Pricer. 1	Pricer. 2	Pricer. 3	Pricer. 4
647187- white				956,91	1052,66	1084,57	1127,13
647188- black				956,91	1052,66	1084,57	1127,13

### RomboSeat for RomboTable incl. Max Power Grommet

Includes: RomboSeat adapted with hole pattern for RomboTable.

	W. 1000	H. 450	D. 650	Pricer. 1	Pricer. 2	Pricer. 3	Pricer. 4
647189- white				956,91	1052,66	1084,57	1127,13
647190- black				956,91	1052,66	1084,57	1127,13

### RomboSeat for RomboTable & RomboScreen incl. Max Power Grommet

Includes: RomboSeat adapted with hole pattern for RomboTable and

	W. 1000	H. 450	D. 650	Pricer. 1	Pricer. 2	Pricer. 3	Pricer. 4
647191- white				956,91	1052,66	1084,57	1127,13
647192- black				956,91	1052,66	1084,57	1127,13

### RomboSeat with wheel incl. Max Power Grommet

Includes: RomboSeat with lockable wheels. W. 1000 H. 475 D. 650

	W. 1000	H. 475	D. 650	Pricer. 1	Pricer. 2	Pricer. 3	Pricer. 4
647193- white				1095,21	1180,32	1201,60	1244,15
647194- black				1095,21	1180,32	1201,60	1244,15

### RomboSeat with wheel for RomboTable incl. Max Power Grommet

Includes: RomboSeat with lockable wheels, adapted with hole pattern for

	W. 1000	H. 475	D. 650	Pricer. 1	Pricer. 2	Pricer. 3	Pricer. 4
647195- white				1095,21	1180,32	1201,60	1244,15
647196- black				1095,21	1180,32	1201,60	1244,15

### RomboSeat with wheel for RomboTable & Screen incl. Max Power Grommet

Includes: RomboSeat with lockable wheels adapted with hole pattern for

	W. 1000	H. 475	D. 650	Pricer. 1	Pricer. 2	Pricer. 3	Pricer. 4
647197- white				1095,21	1180,32	1201,60	1244,15
647198- black				1095,21	1180,32	1201,60	1244,15

### Important information:

RomboSeat is made of: MDF, foam.

RomboScreen is made up of: Plywood, textile, lamination.

RomboTable is made of: Metal, MDF, laminate.

### Order procedure for RomboSeat with socket:

1: Choose textile for RomboSeat.

Ex: 647187-517-206. Colour textile = colour on seam.

2: Choose textile for RomboScreen.

Ex: 647187-519-206. Colour textile = colour on seam.

3: Choose colour for RomboTable.

Ex: 647180-2.

## ROMBOBACKREST

### RomboBackrest

Fastens with two straps around the screen on a RomboScreen.

Material: Molded wooden back with foam and foam laminated textile.

W. 705 H. 300 D. 150

647164-	276,06	286,70	350,53	403,72
---------	--------	--------	--------	--------

### Order procedure for Rombobackrest:

Specify the article number as follow:

Backrest - textile colour (seam as textile colour).

### Prices apply to colours in the textile chapter. Textiles that can be selected:

Pricer. 1: Event Screen +, Houston Reflect, Mica, Omega, Pearl, Slope, Tonal

Pricer. 2: Era, Kaiman, Lido, Noble lux, Rivet

Pricer. 3: Ally, Blazer, Bond, Synergy

Pricer. 4: Illusion II, Remix 3



## PIECE OF CAKE

A triangle formed seating furniture that creates a circle when 6 pieces are combined. Available in two different seat heights, both of which are adapted to the Sit Around table. Dress in any soft seating textile from our standard range.



## PIECE OF CAKE

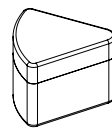

### Big piece of cake

Including: 1 piece of cake.  
W. 762 H. 500 D. 725

647145-

Pricer. 1	Pricer. 2	Pricer. 3	Pricer. 4
541,28	578,30	627,55	701,38

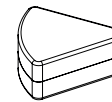

### Small piece of cake

Including: 1 piece of cake.  
W. 762 H. 300 D. 725

647140-

405,85	442,77	516,60	565,85
--------	--------	--------	--------

Triangle shaped seating, 6 pcs make a circle. Made of foam, dressed in textile with artificial leather underneath.

### Prices apply to colours in the textile chapter. Textiles that can be selected:

Pricer. 1: Event Screen +, Houston Reflect, Mica, Omega, Pearl, Slope, Tonal  
Pricer. 2: Era, Kaiman, Lido, Noble lux, Rivet  
Pricer. 3: Ally, Blazer, Bond, Synergy  
Pricer. 4: Illusion II, Remix 3

### Specify the article number as follow:

Piece of cake - Colour of textile (seam as textile colour).

## SIT AROUND

Round table in 2 different heights, 500 and 730 mm. The tables are delivered with a round table top in optional laminate and with a lacquered base in black or white. Choose laminate in black, white, oak, or walnut. Associated seating furniture shaped like pieces of cake to place around the table.



### Sit Around 730 mm

Tabletop in laminate. Base in lacquered metal.  
H. 730 Ø 700

891079-1	black/white	492.02
891079-2	black/black	492.02
891080-1	ash/white	492.02
891080-2	ash/black	492.02
891081-1	white/white	492.02
891081-2	white/black	492.02
891082-1	oak/white	492.02
891082-2	oak/black	492.02
891083-1	walnut/white	492.02
891083-2	walnut/black	492.02

Also available in height 500 mm.



## NO POCKET TABLE

### No Pocket Table

The table is available in three combinations: oak veneer with a white stand, oak veneer with a black stand and black lacquered oak veneer with a black stand.

W. 580 H. 665 D. 380

891044	oak/white	410.00
891045	oak/black	410.00
891046	black lacquered/black	410.00

No Pocket Table is, as the name explains, an updated version of the very popular Pocket Table, but without the pocket. A stylish and modern table that works as decorations just as well for laptop work. The table is easy to move and fits several spaces.



## SIT AROUND

Round table in 2 different heights, 500 and 730 mm. The tables are delivered with a round table top in optional laminate and with a lacquered base in black or white. Choose laminate in black, white, oak, or walnut. Associated seating furniture shaped like pieces of cake to place around the table.

### Sit Around 730 mm

Tabletop in laminate. Base in lacquered metal.  
H. 730 Ø 700

891079-1	black/white	492.02
891079-2	black/black	492.02
891080-1	ash/white	492.02
891080-2	ash/black	492.02
891081-1	white/white	492.02
891081-2	white/black	492.02
891082-1	oak/white	492.02
891082-2	oak/black	492.02
891083-1	walnut/white	492.02
891083-2	walnut/black	492.02

See information about the laminates in the textile chapter.



## POCKET TABLE

### Pocket Table

The table is available in three combinations: oak veneer with a white stand, oak veneer with a black stand and black lacquered oak veneer with a black stand. Pocket in artificial leather.

W. 580 H. 665 D. 380

891041	oak/white	533.09
891042	oak/black	533.09
891043	black lacquered/black	533.09



### Sit Around 500 mm

Tabletop in laminate. Base in lacquered metal.  
H. 500 Ø 700

891084-1	ash/white	467.34
891084-2	ash/black	467.34
891085-1	white/white	467.34
891085-2	white/black	467.34
891086-1	oak/white	467.34
891086-2	oak/black	467.34
891087-1	walnut/white	467.34
891087-2	walnut/black	467.34
891088-1	black/white	467.34
891088-2	black/black	467.34



Soft seating box with lid for storage. Fits perfectly under the desk. The SMS-box is available in a large variation of textiles and zippers so it is easy to match it with other furniture in the office.

## SMS-BOX SIT - MEET - STORE



<b>SMS-Box, black wheels</b> 647020- W. 370 H. 500 D. 370	<b>Pricer. 1</b>	<b>Pricer. 2</b>	<b>Pricer. 3</b>	<b>Pricer. 4</b>
	314,04	329,79	392,98	487,98

<b>SMS-Box, white wheels</b> 647021- W. 370 H. 500 D. 370	314,04	329,79	392,98	487,98
--	--------	--------	--------	--------

<b>SMS-Box, no wheels</b> 647050- W. 370 H. 500 D. 370	282,34	298,83	365,11	465,00
---	--------	--------	--------	--------

Specify the article number as follow:

SMS-Box - textile colour - zip colour.

Seam will be similar to zipper tape.



## SQUARE BENCH



### SQUARE BENCH

*Square Bench is always fitted with wheels. Can be used as free-standing or connected to other Benches.*

	<b>Pricer. 1</b>	<b>Pricer. 2</b>	<b>Pricer. 3</b>	<b>Pricer. 4</b>
110930- W. 900H. 450 D. 900	1279,79	1325,96	1562,34	1836,91



### BENCH COVERS

<b>Bench Cover</b> 110950- W. 1800 H. 80 D. 900	605,74	739,57	887,13	1030,21
--	--------	--------	--------	---------



<b>Square Bench Cover</b> 110960- W. 900 H. 80 D. 900	403,51	486,91	560,96	647,45
--	--------	--------	--------	--------



## FREE BENCH



### FREE BENCH

*Square Bench is always fitted with wheels. Can be used as free standing or connected to other Benches.*

<b>Free Bench</b> 110920- W. 1800 H. 450 D. 900	<b>Pricer. 1</b>	<b>Pricer. 2</b>	<b>Pricer. 3</b>	<b>Pricer. 4</b>
	1779,79	1883,19	2216,81	2652,02

<b>Free Bench, Table Top white</b> 110921- W. 1800 H. 450 D. 900	1963,40	2066,91	2400,53	2835,64
---	---------	---------	---------	---------

<b>Free Bench, Table Top black</b> 110923- W. 1800 H. 450 D. 900	1963,40	2066,91	2400,53	2835,64
---	---------	---------	---------	---------

<b>Free Bench, Table Top silver</b> 110928- W. 1800 H. 450 D. 900	1963,40	2066,91	2400,53	2835,64
--	---------	---------	---------	---------

Note: The Hut Bench with Table Top includes 2 x 2 sockets. Table Top is a power outlet mounted in the bench. Max load 400 kg per Bench. Bench height includes mattress and wheels.

Prices apply to colours in the textile chapter. Textiles that can be selected:

Pricer. 1: Event Screen +, Houston Reflect, Mica, Omega, Pearl, Slope, Tonal

Pricer. 2: Era, Kaiman, Lido, Noble lux, Rivet

Pricer. 3: Ally, Blazer, Bond, Synergy

Pricer. 4: Illusion II, Remix 3

Bench – the key object in three formats as a part of The Hut Lounge collection. Place a Free Bench in the entrance fitted with Table Top to meet every visitor's wish. Combine the Square Bench with any constellation to create dynamic and add an extra nice design detail.



## OFFICE BALLZ

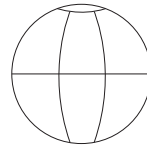

### Office Ballz

*Delivered with a pump.*

	Pricer. 1	Pricer. 2	Pricer. 3	Pricer. 4
<b>Office Ballz big</b>				
640065- Ø 650	361,81	392,77	452,02	519,15
<b>Office Ballz small</b>				
640055- Ø 550	347,23	375,21	437,87	505,74
<b>Office Ballz big, PVC-free</b>				
640066- Ø 650	476,38	507,34	566,81	634,04
<b>Office Ballz small, PVC-free</b>				
640056- Ø 550	461,91	490,00	552,45	620,32

**Prices apply to colours in the textile chapter. Textiles that can be selected:**

Pricer. 1: Event Screen +, Houston Reflect, Mica, Omega, Pearl, Slope, Tonal  
 Pricer. 2: Era, Kaiman, Lido, Noble lux, Rivet  
 Pricer. 3: Ally, Blazer, Bond, Synergy  
 Pricer. 4: Illusion II, Remix 3

Specify the article number as follow:

Office Ballz - textile colour - zip colour.

Not available with fishbone zip.

Seam will be similar to zipper tape.

A fun and great seating furniture for the office that strengthens muscle groups in your back and legs and keep them active while you work. The Office Ballz is available in two sizes in a large variation of textile and zippers so it is easy to match it with other furnishings in the office. You regulate the inner ball easily with the included pump and the bottom is reinforced which makes it stable.



## OFFICE BALLZ MEDLEY

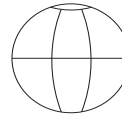

### Office Ballz Medley

*The leather details are always black. The zip is always silver.*

640650	Ø 650	grey	361.81
640651	Ø 650	beige	361.81
640652	Ø 650	blue/grey	361.81
640653	Ø 650	green/beige	361.81

### Office Ballz Medley, PVC-free

*The leather details are always black. The zip is always silver.*

640654	Ø 650	grey	476.38
640655	Ø 650	beige	476.38
640656	Ø 650	blue/grey	476.38
640657	Ø 650	green/beige	476.38

Office Ballz Medley is always unique thanks to the textile cover produced by left over fabric from our standard range soft seating textiles: Synergy, Remix, Blazer, Noble Lux, Slope, Mica, Event Screen, Lido, Bond and Rivet. The textile cover is available in four colour themes and is made of these textiles. Medley is built up by an inflatable pilates ball inside, textile cover and a metal plate in the bottom for stability and ergonomic benefits when used. The handle and leather protecting the metal plate are also made of left over material.



## IQSEAT

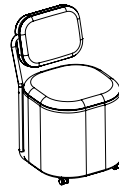

### iQseat

Seam is always like textile. Details/wheels can be chosen in white or black. Two lockable wheels. Max loading: 144 kg. Seat height: 500 mm. W. 500 H. 840 D. 690

	Pricer. 1	Pricer. 2	Pricer. 3	Pricer. 4
647503- Details in white	1048,51	1205,96	1251,81	1297,66
647504- Details in black	1048,51	1205,96	1251,81	1297,66

#### Specify the article number as follow:

iQseat - Colour of textile (Seam will be similar to textile colour).

#### Prices apply to colours in the textile chapter. Textiles that can be selected:

Pricer. 1: Event Screen +, Houston Reflect, Mica, Omega, Pearl, Slope, Tonal  
 Pricer. 2: Era, Kaiman, Lido, Noble lux, Rivet  
 Pricer. 3: Ally, Blazer, Bond, Synergy  
 Pricer. 4: Illusion II, Remix 3

Flexible, comfortable, playful and stylish - a few words that describe iQseat. Lean back on this soft seat with a backrest or turn the backrest into a table when writing down your ideas. iQseats multi-functionality with wheels makes it suitable in many different spaces. Choose from white or black details - the table, wheels and pipe follow that colour choice. The design duo Henrik Kjellberg and Jon Lindström from o4i Design Studio have designed iQseat, which Götessons has developed and produced.

## IQUBE

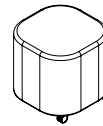

### iQube

Seam always matches the fabric. Wheels in white or black of which two are lockable. Maximum load 144 kg. Seat height 500 mm. The product is delivered pre-assembled.. W. 500 H. 500 D. 500

	Pricer. 1	Pricer. 2	Pricer. 3	Pricer. 4
647510- white wheels	632,77	802,77	862,66	902,55
647511- black wheels	632,77	802,77	862,66	902,55

#### Specify the article number as follow:

iQube - Colour of textile (Seam will be similar to textile colour).



iQube is a playful and flexible stool on wheels. With its simple design the iQube are perfect for short office meetings or in the classroom. The wheels make the stool easy to rearrange. Choose fabric and color from our range, that suits or stands out and gives the room a little bit of color. Designed by Henrik Kjellberg and Jon Lindström from o4i Design Studio.





## OFFICE NAP

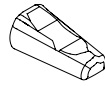

### Office Nap

Inner bag covered with the textile of your choice. The bottom is always in grey artificial leather.

	Pricer. 1	Pricer. 2	Pricer. 3	Pricer. 4
640075- W. 600 H. 300 L. 1400	607,66	709,04	779,36	820,64

### Office Nap without vinyl

Inner bag covered with the textile of your choice.

640076- B. 600 H. 300 L. 1400	591,49	703,19	770,21	814,89
-------------------------------	--------	--------	--------	--------

### Prices apply to colours in the textile chapter. Textiles that can be selected:

Pricer. 1: Event Screen +, Houston Reflect, Mica, Omega, Pearl, Slope, Tonal  
 Pricer. 2: Era, Kaiman, Lido, Noble lux, Rivet  
 Pricer. 3: Ally, Blazer, Bond, Synergy  
 Pricer. 4: Illusion II, Remix 3

### Specify the article number as follow:

Office Nap - textile colour - zip colour.  
 Not available with fishbone zip.  
 Seam will be similar to zipper tape.

A soft seating furniture for the short nap to quickly get energy for the next meeting. Ideal for creative meetings in the activity-based landscape. A short nap during working hours can enhance performance and job satisfaction. Office Nap is designed and manufactured in Sweden to fit the office environment and is made of eco-friendly materials.



## HANG ON

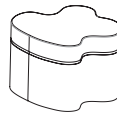

### Hang On big

	Pricer. 1	Pricer. 2	Pricer. 3	Pricer. 4
647060- W. 830H. 600	564,68	629,36	662,02	782,66



### Hang On medium

647080- W. 830H. 500	516,38	596,81	612,98	758,51
----------------------	--------	--------	--------	--------

### Prices apply to colours in the textile chapter. Textiles that can be selected:

Pricer. 1: Event Screen +, Houston Reflect, Mica, Omega, Pearl, Slope, Tonal  
 Pricer. 2: Era, Kaiman, Lido, Noble lux, Rivet  
 Pricer. 3: Ally, Blazer, Bond, Synergy  
 Pricer. 4: Illusion II, Remix 3

### Specify the article number as follow:

Hang On - textile colour - zip colour.  
 Seam will be similar to zipper tape.

A sleek and modern seating furniture to create more diverse environments. The product is also a very good sound absorber. Hang On is available in two different heights and with a wide range of textiles and zippers.





# ERGONOMIC PRODUCTS, MATS AND FLOOR PROTECTION

**P**rotect everything from top to bottom!  
Ergonomical products, smart foot and wrist support that make sure you are in the right position when you work. A variety of types of removable carpets and floor coverings to prevent unnecessary wear.



## YOGA MAT STANDZON

Yoga is an ergonomically designed anti-fatigue mat that is ideal for standing work. The mat has a smart handle, making it easy to hang on either wall or by your screen on the desk when it isn't being used. Fits hanging on the ScreenIT A30 hook.



### Yoga mat StandzOn

Soft ergonomic mat with cork or textile-clad surface. The core is made of absorbing and silencing material polyurethane.

W. 980 H. 18 D. 520

180005	grey	128.94
180006	cork	135.11



## DOT STANDZON

Dot StandzOn, a sibling to popular Yoga Mat StandzOn. The round shape nicely breaks off the classic square and rectangular shapes office furnishing often consists of. With its smart handle, the mat can easily be hung on a hook mounted on the wall, desk or a ScreenIT A30.



### Anti-fatigue mat Dot StandzOn

Soft ergonomic mat in cork or textile-clad surface. The core is made of absorbing and silencing material polyurethane.

Ø 600 H. 18

180011	grey	128.94
180012	cork	135.11



### Hook with screws

Hook to be mounted under the desk. Screws included.

W. 40 H. 53 D. 58

671088-1	white	14.89
671088-2	black	14.89
671088-3	silver	14.89



### Wall hook for mat

W. 40 H. 55 D. 41

671076-1	white	17.34
671076-2	black	17.34
671076-3	silver	17.34



### Hook for ScreenIT A30

Hook in metal to be hung over the desk screen.

W. 60 H. 101 D. 48

671098	silver	20.21
671098-1	white	20.21
671098-2	black	20.21



## ANTI-FATIGUE MAT STANDZON

An ergonomically designed mat ideal for standing work. StandzOn is a soft mat produced with polyurethane core which is sound absorbing and relieving. With its smart handle, the mat can easily be hung on a hook mounted on the wall, desk or a ScreenIT A30. Easy to wipe clean with a damp cloth.

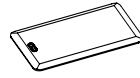

### StandzOn

*Ergonomic soft mat produced in polyurethane. Anti-static.*

*W. 820 H. 18 D. 510*

180003

black

105.00

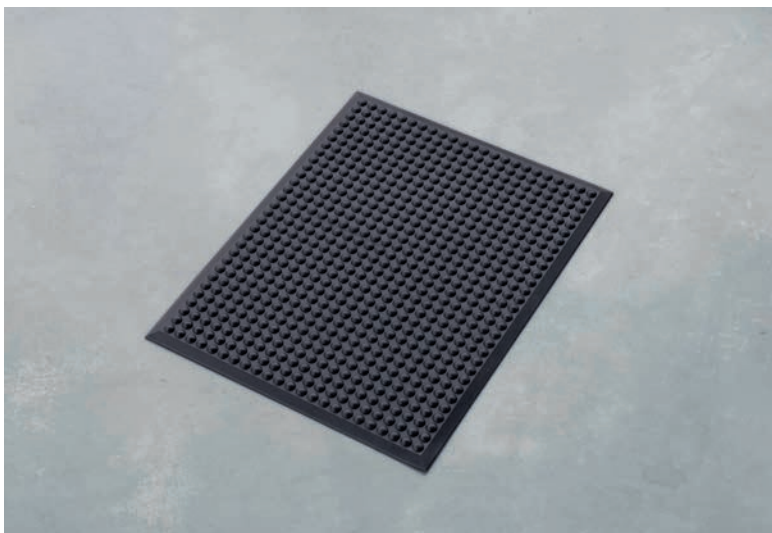

## ANTI-FATIGUE MAT BUBBLE STANDZON

Ergonomic shaped mat with massagefunction, suits your standing desk. The carpet is made of polyurethane soundproofing material.



### Bubble StandzOn

*Ergonomic soft mat with massage function.*

*W. 625 H. 15 D. 450*

180002

grey

139.57



## FLOOR PROTECTION STANDARD

The floor cover is designed for both hard and soft floors. The protection is rectangular with rounded corners. Made of high quality transparent and black polyvinyl.



### Floor Protection Standard (for plain floors)

Rectangular floor protection made of high quality polyvinyl, thickness 2,5 mm, delivery of 1 piece in cardboard packaging.

233030	L. 1000	W. 1200	transparent	96.70
233030-2	L. 1000	W. 1200	black	101.70
233040	L. 1500	W. 1200	transparent	130.21
233040-2	L. 1500	W. 1200	black	156.06
233050	L. 2000	W. 1200	transparent	156.06
233050-2	L. 2000	W. 1200	black	188.83



## FLOOR PROTECTION STANDARD



### Floor Protection Standard (for carpet covered floors)

Rectangular floor protection made of high quality polyvinyl. Thickness 2,5 mm. Anti-slip bottom to keep mat securely in place. Delivery of 1 piece in cardboard packaging.

233000	L. 1000	W. 1200	transparent	78.94
233000-2	L. 1000	W. 1200	black	139.04
233010	L. 1500	W. 1200	transparent	114.36
233010-2	L. 1500	W. 1200	black	191.06
233020	L. 2000	W. 1200	transparent	134.47
233020-2	L. 2000	W. 1200	black	259.15



## FOOT SUPPORT

The foot support is angled and adjustable with pressure from the foot. It has a powerful construction and the upper side is covered with a durable rubber mat.



### Foot support

Strong bended metal tube, 16 mm rubber covered wooden plate.  
W. 550 H. 155 D. 365

125001	black	123.40
--------	-------	--------



Traditional armrest with great support and depth. Covered with strong Lycrafabric.

## ARM REST SIMPLE REST



### Simple Rest

*Traditional arm rest. Holders can be adjusted for round desks.*

*Covered with Lycra fabric.*

*H. 25 D. 230 L. 670*

122006

black

155.53



## CHAIR PAD



### Chair pad

*Available in 10 sizes. Is pushed on the end of the chair leg.*

*Article number refers to 1 pcs.*

14-3	Fits chair leg Ø14	H. 22	grey	1.91
16-3	Fits chair leg Ø16	H. 25	grey	1.91
18-3	Fits chair leg Ø18	H. 25	grey	1.91
19-3	Fits chair leg Ø19	H. 27	grey	1.91
20-3	Fits chair leg Ø20	H. 27	grey	1.91
22-3	Fits chair leg Ø22	H. 28	grey	1.91
25-3	Fits chair leg Ø25	H. 28	grey	2.98
28-3	Fits chair leg Ø28	H. 31	grey	2.98
32-3	Fits chair leg Ø32	H. 40	grey	5.21
40-3	Fits chair leg Ø40	H. 40	grey	5.21







# ARTIFICIAL PLANTS, POTS

**D**ecorative high quality plants for any environment. The plants are realistic, require minimal maintenance and are allergy friendly.



## FLORA PANEL

Plant panel to place on the wall, for example together with Plain/Plant panel. Several different plants sit close together to create a green oasis.



Flora panel 1



Flora panel 2



Flora panel 3

### Flora panel 1

Materials: Artificial plants, black wooden frame.

W. 580 H. 580 D. 30

160125

382.45

### Flora panel 2

Materials: Artificial plants, black wooden frame.

W. 580 H. 580 D. 30

160126

382.45

### Flora panel 3

Materials: Artificial plants, black wooden frame.

W. 580 H. 580 D. 30

160127

382.45

Mounting on the wall with two metal fittings located on the back of the panel.  
Customer is responsible for suitable screw on wall.



## SEASONAL BOUQUET/VIENNA

A bouquet that never wilts is our Seasonal Bouquet, featuring carefully selected flowers that are just as suitable for the home as they are for an entrance, dining room, lobby, or office. The bouquet is seasonally inspired and therefore may vary in quantity and types. Visit Götessons' website for up-to-date information. Pair it with the Vienna vase for a perfect match.



H. 1000 mm

### Seasonal bouquet

*Contents: artificial flowers. The quantity and varieties may vary with the season. Visit [www.gotessons.com](http://www.gotessons.com) for up-to-date information.*

H. 1000

160128

206,91



H. 410 mm

### Vase Vienna

*Material: glass.*

H. 410 Ø 90

160129

79,68

A designed vase that fits in most environments. Feel free to complete with our flower bouquet Seasonal bouquet.



## PLANTPANEL SLICE

Create a striking wall in the room with the help of PlantPanel Slice. Consists of molded felt and can be ordered in several different colors for more effect. Make the wall even more alive and add plants. The panel is prepared with holes for placing plants without a pot. Design Henrik Kjellberg and Jon Lindström, o4i Design Studio.

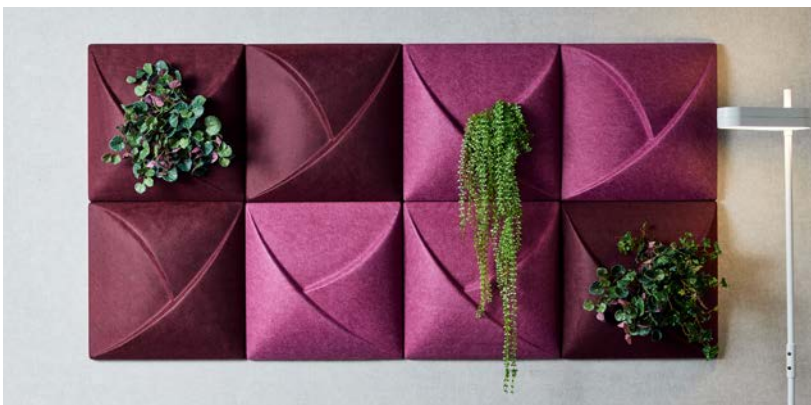

### PlantPanel Slice

Molded felt from at least 55 % recycled PET. Mounted on wall with rail, suspension included. Prepared with holes for two plants.

W. 580 H. 580 D. 140

121362-1	gravel	206,91
121362-2	slate	206,91
121362-3	pine	206,91
121362-4	moss	206,91
121362-5	plum	206,91
121362-6	cherry	206,91
121362-7	cyan	206,91
121362-8	ivory	206,91
121362-9	hemp	206,91

### EcoSUND for Plain and Plantpanel

Place behind Wallpanel for sound absorption. Only raw white EcoSUND.

W. 480 H. 570 D. 20

126400-1	white	20,74
----------	-------	-------

Plants that fit in the PlantPanel Slice:



#### Ivy without a pot

H. 550 Ø 270 **PVC-free**

160159 green 52.66



#### Senecio without a pot

H. 400 Ø 300

160160 green/purple 34.04



#### Dischidia without a pot

H. 700 Ø 150 **PVC-free**

160158 green 42.02

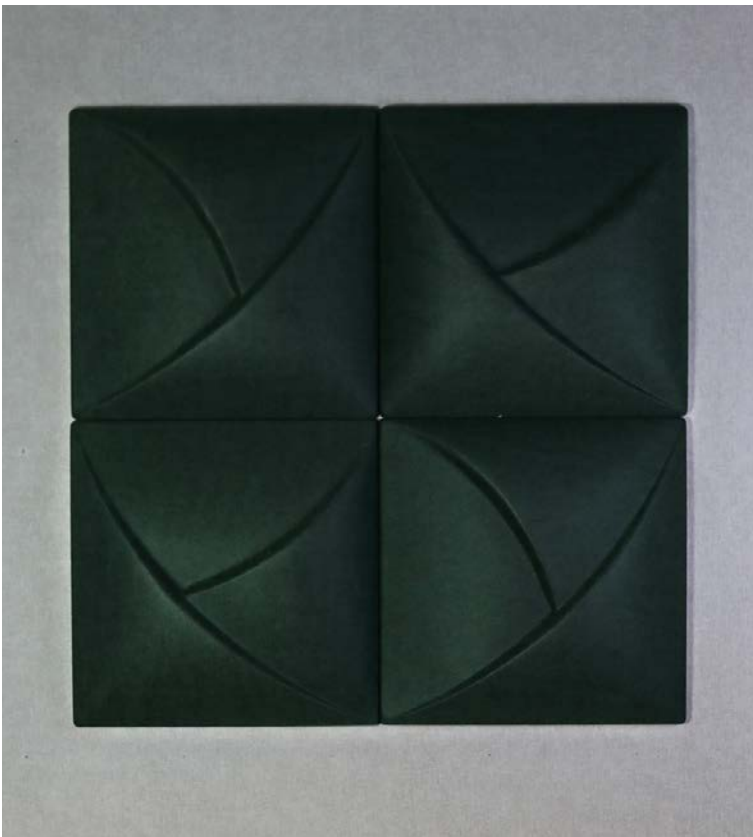

## SLICEPANEL

## LEAFPANEL

Create a striking wall in the room with the help of Leaf/SlicePanel. Consists of molded felt and can be ordered in several different colors for more effect. Design Henrik Kjellberg and Jon Lindström, o4i Design Studio.



Gravel



Slate



Pine



Moss



Plum

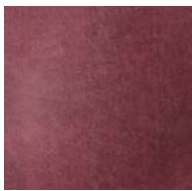

Cherry



Cyan



Ivory



Hemp

### SlicePanel

Molded felt from at least 55 % recycled PET. Mounted on wall with rail, suspension included.

W. 580 H. 580 D. 140

121361-1	gravel	201,60
121361-2	slate	201,60
121361-3	pine	201,60
121361-4	moss	201,60
121361-5	plum	201,60
121361-6	cherry	201,60
121361-7	cyan	201,60
121361-8	ivory	201,60
121361-9	hemp	201,60

### EcoSUND for Plain and Plantpanel

Place behind Wallpanel for sound absorption. Only raw white EcoSUND.

W. 480 H. 570 D. 20

126400-1	white	20,74
----------	-------	-------

### LeafPanel

Molded felt from at least 55 % recycled PET. Mounted on wall with rail, suspension included.

W. 580 H. 580 D. 100

121360-1	gravel	201,60
121360-2	slate	201,60
121360-3	pine	201,60
121360-4	moss	201,60
121360-5	plum	201,60
121360-6	cherry	201,60
121360-7	cyan	201,60
121360-8	ivory	201,60
121360-9	hemp	201,60



## PLANTPANEL

Create a unique and vibrant office with PlantPanel. A moulded panel that can be filled with artificial plants to make the room dynamic. Design Henrik Kjellberg and Jon Lindström, o4i Design Studio.

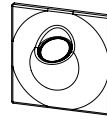

### PlantPanel

Moulded felt made of at least 55% recycled PET. Mounted on the wall with included wall mount. Pot for artificial plant included, inner dimensions Ø 140, H. 130. W. 580 H. 580 D. 210

121210-1	gravel	229.04
121210-2	slate	229.04
121210-3	pine	229.04
121210-4	moss	229.04
121210-5	plum	229.04
121210-6	cherry	229.04
121210-7	cyan	229.04
121210-8	ivory	229.04
121210-9	hemp	229.04

### EcoSUND for Plain and Plantpanel

Place behind Wallpanel for sound absorption. Only raw white EcoSUND. W. 480 H. 570 D. 20

126400-1	white	20.74
----------	-------	-------

Plants that fit in PlantPanel:

<b>Fittonia 340</b> H. 340 Ø 100	<b>PVC-free</b>	<b>Eucalyptus 500</b> H. 500 Ø 125	<b>PVC-free</b>
160130 green	29.79	160019 green	87.23
<b>Kalanchoe 250</b> H. 250 Ø 110	<b>PVC-free</b>	<b>Ivy 450</b> H. 450 Ø 100	<b>PVC-free</b>
160131 green	42.13	160133 green	60.43
<b>Peperomia 450</b> H. 450 Ø 100	<b>PVC-free</b>	<b>Ivy 850</b> H. 850 Ø 150	<b>PVC-free</b>
160132 green	29.79	160072 green	203.83
<b>Golden Pothos 1000</b> H. 1000 Ø 110	<b>PVC-free</b>	<b>Palm 350</b> H. 350	<b>PVC-free</b>
160145 green	76.70	160141 green	28.51
<b>Fern 450</b> H. 450 Ø 112			
160074 green	72.66		

To see which plants are recommended for which pots, see [www.gotessons.com](http://www.gotessons.com).



## PLAINPANEL

Moulded panel with a simple design to create life in the room. Design Henrik Kjellberg and Jon Lindström, o4i Design Studio.

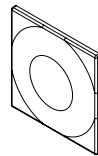
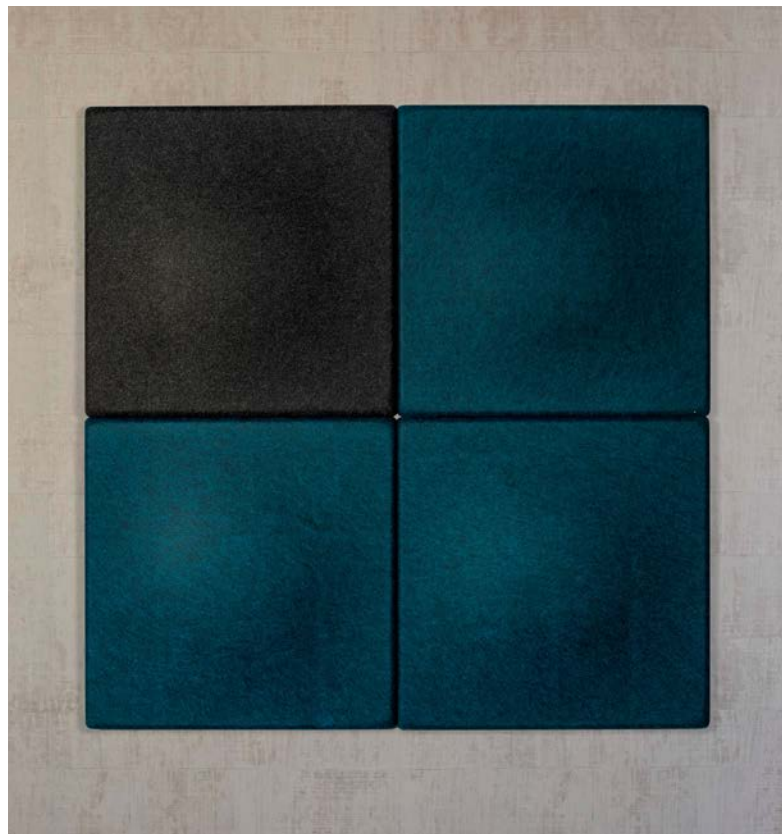

### PlainPanel

Moulded felt made of at least 55% recycled PET. Mounted on the wall with included wall mount.  
W. 580 H. 580 D. 60

121211-1	gravel	162.45
121211-2	slate	162.45
121211-3	pine	162.45
121211-4	moss	162.45
121211-5	plum	162.45
121211-6	cherry	162.45
121211-7	cyan	162.45
121211-8	ivory	162.45
121211-9	hemp	162.45

### EcoSUND for Plain and Plantpanel

Place behind Wallpanel for sound absorption. Only raw white EcoSUND.  
W. 480 H. 570 D. 20

126400-1	white	20.74
----------	-------	-------



Gravel

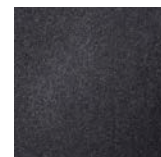

Slate

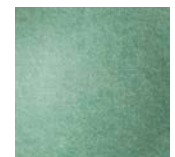

Pine



Moss

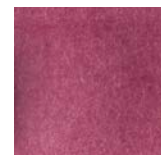

Plum

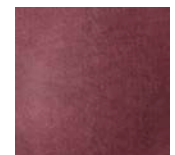

Cherry



Cyan



Ivory

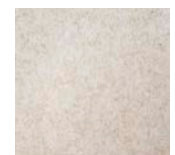

Hemp







## ARTIFICIAL PLANTS

Add green details with the shape of our realistic plants to decorate the office, hotel or conference room. Natural elements create a welcoming feeling and our bigger plants act as both great interior details and perfect room dividers. The plants are just as perfect next to your desk as in an own oasis together with a group of our comfortable Office Nap, see page 104.

Note: Oil Drum and outer plant pots are not included unless otherwise specified, even if it is in the picture.

Largest diameter dimensions are specified. External dimensions are specified (pot).

### ROMBOPLANTER



**RomboPlanter 450 mm**  
W. 1000 H. 450 D. 650

	Pricer. 1	Pricer. 2	Pricer. 3	Pricer. 4
647175-	1063,30	1116,49	1169,68	1222,87

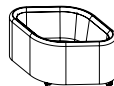

**RomboPlanter 475 mm with wheels**

647176- with wheels	1169,68	1222,87	1276,06	1329,26



**RomboPlanter 650 mm**  
W. 1000 H. 650 D. 650

647177-	1329,26	1382,45	1435,64	1488,83

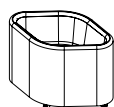

**RomboPlanter 675 mm with wheels**

647178- with wheels	1435,64	1488,83	1542,02	1595,21

Important information:

RomboPlanter is made up of: MDF, covered with foam and textile.

Waterproof pot included.

The wheels are always black, lockable.

Specify the article number as follow:

RomboPlanter - Colour of textile (Seam will be similar to textile colour).

RomboPlanter is a textile-covered pot that can be filled with plants. Available in two different heights for the possibility of nice arrangements. Design Henrik Kjellberg and Jon Lindström, o4i Design Studio.



## PLANT DIVIDER

Plant Divider is a textile dressed room divider to be combinable with plants and is a personal and flexible interior design detail. Built with 30 mm sound absorbents, it contributes to a better sound environment. Mounted with lockable wheels for easy movement.



### PLANT DIVIDER 1100

#### Plant Divider 1100 mm

*Areca Palm and Longifolia are not recommended for this product due to their sizes.*

*Always seam like textile.*

*See price ranges on page 6-16.*

	Pricer. 1	Pricer. 2	Pricer. 3	Pricer. 4
161080- Plant Divider small, white wheels	1265,00	1426,60	1610,21	1811,49
161081- Plant Divider small, black wheels	1265,00	1426,60	1610,21	1811,49
161082- Plant Divider large, white wheels	1840,74	2047,45	2294,68	2576,60
161083- Plant Divider large, black wheels	1840,74	2047,45	2294,68	2576,60

Small; Out. meas: W. 820 H. 1100 D. 320 In. meas: W. 790 H. 290 D. 290

Large; Out. meas: W. 1620 H. 1100 D. 320 In. meas: W.1590 H. 290 D. 290.

Given outer measurements include wheels. Inner measurements state place for pot.

#### ORDER PLANT DIVIDER

Art.no - Colour of textile Example: 161080-208.

Plant Divider small-white wheels- Lido 154 Mustard.



### PLANT DIVIDER 800

#### Plant Divider 800 mm

*Areca Palm and Longifolia are not recommended for this product due to their sizes. Always seam like textile.*

160083- Plant Divider small, white wheels	942,87	986,49	1088,09	1182,55
160084- Plant Divider small, black wheels	942,87	986,49	1088,09	1182,55
160085- Plant Divider large, white wheels	1378,40	1465,53	1639,79	1835,85
160086- Plant Divider large, black wheels	1378,40	1465,53	1639,79	1835,85

Small; Out. meas: W. 820 H. 800 D. 320 In. meas: W. 790 H. 290 D. 290

Large; Out. meas: W. 1620 H. 800 D. 320 In. meas: W.1590 H. 290 D. 290..

Given outer measurements include wheels. Inner measurements state place for pot.

#### ORDER PLANT DIVIDER

Art.no - Colour of textile Example: 161080-208.

Plant Divider small-white wheels- Lido 154 Mustard.

To see which plants are recommended for which pots, see [www.gotessons.com](http://www.gotessons.com).



## PLANT DIVIDER POT

### Plant Divider pot

Material: ABS-plastic. 50 litre.

160260 W. 790 H. 270 D. 290

black

115.64

Waterproof pot to Plant Divider. One pot fits to Plant Divider small, two pots is needed for the Plant Divider large.

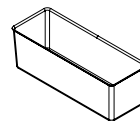

ARTIFICIAL PLANTS



H. 2600 mm

**Longifolia 2600**  
*H. 2600 Ø 195*  
 160076 green 1435,64



H. 2100 mm

**Areca Palm 2100**  
*H. 2100 Ø 170*  
 160000 green 405,64



H. 2000 mm

**Alocasia 2000**  
*H. 2000 Ø 180*  
 160162 green 584,57



H. 1800 mm

**Ficus Robusta 1800**  
*H. 1800 Ø 170*  
 160075 green 350,96



H. 1600 mm

**Olive Tree 1600**  
*H. 1600 Ø 160*  
 160005 green 393,51



H. 1200 mm

**Alocasia 1200**  
*H. 1200 Ø 140*  
 160161 green 265,43



H. 1000 mm

Olive Tree 1000  
H. 1000 Ø 155 PVC-free  
160136 green 280.00



H. 900 mm

Fikus Elastica 900  
H. 900 Ø 160  
160135 green 267.66



H. 900 mm

Neanthe Bella Palm 900  
H. 900 Ø 110 PVC-free  
160151 green 76.70



H. 700 mm

Yucca palm 700  
H. 700 Ø 180 PVC-free  
160152 green 98.62



H. 1800 mm

**Bambu 1800**  
H. 1800 Ø 195 *PVC-free*  
160013 green 266.28



H. 1500 mm

**Bambu 1500**  
H. 1500 Ø 195 *PVC-free*  
160012 green 222.66



H. 1500 mm

**Monstera 1500**  
H. 1500 Ø 190 *PVC-free*  
160001 green 271.28



H. 700 mm

**Monstera 700**  
H. 700 Ø 140 *PVC-free*  
160137 green 84.79



**Grass Miscanthus 1500**  
*H. 1500 Ø 150*  
 160016 green 91.60



**Grass 1300**  
*H. 1300 Ø 130*  
 160009 green 87.23



**Grass 950**  
*H. 950 Ø 105*  
 160008 green 43.19



**Fiddle Leaf Fig Tree 1500**  
*H. 1500 Ø 125*  
 160003 green 182.23



**Fiddle Leaf Fig Tree 900**  
*H. 900 Ø 125*  
 160002 green 105.96



**Eucalyptus 1100**  
*H. 1100 Ø 210* **PVC-free**  
 160071 green 329.04



**Eucalyptus in a pot 500**  
*H. 500 Ø 125* **PVC-free**  
 160019 green 87.23

## DECORATE WITH PLANTS

Our smaller plants are useful in many different ways in pots or in Plant Divider. For several plants there are already a pot included, to put directly on the table.

To make it more dynamic; mix high and low plants.

Note: Oil Drum and outer plant pots are not included unless otherwise specified, even if it is in the picture.

Largest diameter dimensions are specified. External dimensions are specified (pot).



**Peace Lily 1050**  
*H. 1050 Ø 230* **PVC-free**  
 160018 green 233.83



**Sansiveria incl. black pot 900**  
*H. 900 Ø 180* **PVC-free**  
 160015 green 191.49



**Cycas Palm incl. black pot 700**  
*H. 700 Ø 180* **PVC-free**  
 160014 green 281.06



**Anthurium 650**  
*H. 650 Ø 200*  
 160140 burgundy 371.70



**Calathea 550**  
*H. 550 Ø 100*  
 160143 green 43.40



**Calathea 550**  
*H. 550 Ø 100*  
 160144 burgundy 43.40

To see which plants are recommended for which pots, see [www.gotessons.com](http://www.gotessons.com).





Orchid Phalaenopsis incl. glass pot 650  
H. 650 Ø 150  
160010 white 166.91



Aloe Vera incl. black pot 550  
H. 550 Ø 190 PVC-free  
160007 green 136.49



Fern 450  
H. 450 Ø 112 PVC-free  
160074 green 72.66



Palm 350  
H. 350 Ø 100 PVC-free  
160141 green 28.51



Fittonia 340  
H. 340 Ø 100 PVC-free  
160130 green 29.79



Kalanchoe 250  
H. 250 Ø 110 PVC-free  
160131 green 42.13



Wood Chips brown  
Wood chips are made of 100 % conifers,  
coloured with iron oxide. 40 liter. W. 8 kg.  
160065 nature 34.89



Decor stone Slate  
20-40 mm, 5 liter. W. 6.6 kg.  
160066 grey 90.21



Leca  
40 liter. W. 12 kg.  
160096 nature 41.91

ARTIFICIAL PLANTS



**Golden Pothos 1000**  
*H. 1000 Ø 110* **PVC-free**  
 160145 green 76.70



**Hoya 650**  
*H. 650 Ø 250*  
 160134 green 407.98



**Ivy 850**  
*H. 850 Ø 150* **PVC-free**  
 160072 green 203.83



**Ivy 450**  
*H. 450 Ø 100* **PVC-free**  
 160133 green 60.43



**Peperomia 450**  
*H. 450 Ø 100* **PVC-free**  
 160132 green 29.79

To see which plants are recommended for which pots, see [www.gotessons.com](http://www.gotessons.com).



Golden Pothos garland 1900

L. 1900

160150 green 24.68



Eucalyptus garland 1900

L. 1900

160068 green 129.04 *PVC-free*

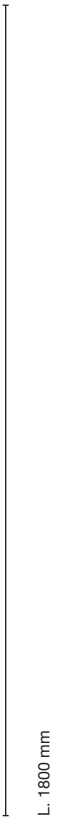

Peperomia garland 1800

L. 1800

160149 green 33.40 *PVC-free*



Ivy garland 1200

L. 1200

160097 green 31.68 *PVC-free*



Fittonia garland 1800

L. 1800

160146 green 50.00 *PVC-free*

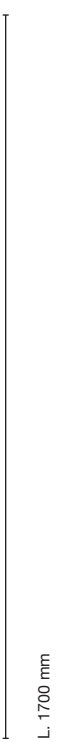

Pumila garland 1700

L. 1700

160147 green 50.00 *PVC-free*

To see which plants are recommended for which pots, see [www.gotessons.com](http://www.gotessons.com).

## POTS

Combine our stylish pots and oil drums with each other to set the right tone in your interior. Easily create a dynamic and modern oasis by combining sizes, nuances and shapes. Use as a room divider or to create a welcoming, furnished space. Place the plant in a pot or oil drum and add some mulch for an extra stylish finish. Tip: fill the pot with paper, packaging or similar to raise the plant. Then add wood chips or decor stone.

---



**Plant pot Napoli large**

*Material: ceramic.*

*H. 590 Ø 330*

160100 brown/black 260.74



**Plant pot Napoli large**

*Material: ceramic.*

*H. 590 Ø 330*

160103 beige 260.74

Slightly more luxurious ceramic pot in a stylish metallic colour. When the pot is fired and glazed, the surface layer can vary from time to time.



**Plant pot Napoli small**

*Material: ceramic.*

*H. 550 Ø 250*

160101 brown/black 126.60



**Plant pot Napoli small**

*Material: ceramic.*

*H. 550 Ø 250*

160104 beige 126.60

To see which plants are recommended for which pots, see [www.gotessons.com](http://www.gotessons.com).



**Plant pot Palermo large**  
 Material: ceramic. Barrel included.  
 H. 230 Ø 220

160108	black	86.49
160109	white	86.49



**Plant pot Palermo small**  
 Material: ceramic. Barrel included.  
 H. 180 Ø 180

160110	black	51.49
160111	white	51.49

To see which plants are recommended for which pots, see [www.gotessons.com](http://www.gotessons.com).



## PLANT POT SQUARE

### Plant Pot Milano wide

W. 790 H. 270 D. 290

160029 light grey 268.30

### Plant Pot Milano high

W. 265 H. 725

160060 light grey 216.06

### Plant Pot Milano low

W. 390 H. 319

160061 light grey 148.83

### Plant Pot Milano wide

W. 790 H. 270 D. 290

160028 dark grey 268.30

### Plant Pot Milano high

W. 265 H. 725

160050 dark grey 216.06

### Plant Pot Milano low

W. 390 H. 319

160051 dark grey 148.83

Note: For Areca Palm pots Milano High and Wide are not recommended. For Longifolia pots Milano High/Low/Wide are not recommended. This is due to its height and width.

## PLANT POT CIRCULAR



### Plant pot Verona large

H. 595 Ø 450

160031 light grey 290.74

### Plant pot Verona medium

H. 530 Ø 400

160032 light grey 193.51

### Plant pot Padua small

H. 300 Ø 400

160033 light grey 118.94

### Plant pot Verona large

H. 595 Ø 450

160040 dark grey 290.74

### Plant pot Verona medium

H. 530 Ø 400

160041 dark grey 193.51

### Plant pot Padua small

H. 300 Ø 400

160043 dark grey 118.94

Largest diameter dimensions are specified. External dimensions are specified (pot).

To see which plants are recommended for which pots, see [www.gotessons.com](http://www.gotessons.com).

## OIL DRUM

As our oil drums come from an industrial environment, the products have a certain patina. This is part of the design. Cover included.



### Oil drum small

H. 600 Ø 405 62 Liter.

160200

black

182.23

### Oil drum medium

H. 815 Ø 480 120 Liter.

160021

black

273.72

### Oil drum large

H. 865 Ø 600 216 Liter.

160020

black

289.04

Place your plants in an oil drum to add an edge to your interior design. With the lid they can conveniently be used as an extra table. As they come from an industrial environment, they have a certain patina. Combine with pots for a stylish mix of materials to create an oasis.

## INSERT OIL DRUM

Material: Corrugated cardboard.

May not be exposed to moisture. Delivered in flat package.

Mounted separately.



### Insert Oil drum 300

160112 H.300 Ø 370

40.11

160113 H.300 Ø 450

40.64

160114 H.300 Ø 560

41.17

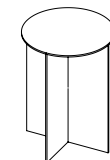

### Insert Oil drum 500

160115 H. 500 Ø 370

44.68

160116 H. 500 Ø 450

45.21

160117 H. 500 Ø 560

45.96



Insert made of corrugated cardboard that fits our Oil Plate and has the purpose to fill out and raise the plant. Available in three sizes and two different heights.

To see which plants are recommended for which pots, see [www.gotessons.com](http://www.gotessons.com).







# LIGHTING

At Gotessons we are investing in efficient, quality lighting with modern design and very competitive pricing. We offer desk lamps with good details for optimal lighting ergonomics to your office, one also available as a floor-lamp. We also have lighting integrated in absorbers which is perfect in large rooms such as conference rooms.



Woodlight is an effective and decorative lighting in white stained ash for The Hut and Half a Hut. The intensity of the light can be adjusted by a touch dimmer. Woodlight can also be angled for maximum effect.



## WOODLIGHT THE HUT COLLECTION

Wood strip in white stained ash. Grey fabric cable. Tilttable and with touch dimmer on cable. Steel brackets painted in black or white. See drawing on web for exact measurements. Adhesive label included that shows where the switch is located when the cable is hidden.

### Woodlight Half a Hut

821168-2	L. 900	ash/black	382.98
821168-12	L. 900	ash/white	382.98
821168-14	L. 900	ash/grey	382.98

### Woodlight The Hut

821169-2	L. 1800	ash/black	437.77
821169-12	L. 1800	ash/white	437.77
821169-14	L. 1800	ash/grey	437.77

### Woodlight Open Half a Hut

821170-2	L. 900	ash/black	382.98
821170-12	L. 900	ash/white	382.98
821170-14	L. 900	ash/grey	382.98

### Woodlight Open Hut

821171-2	L. 1800	ash/black	437.77
821171-12	L. 1800	ash/white	437.77
821171-14	L. 1800	ash/grey	437.77

Watt: 12 W/m  
 Lumens: 1200 lm/m  
 Colour temp: 3000K  
 LUX: max 230  
 CRI: >80  
 Beam angle: 120°

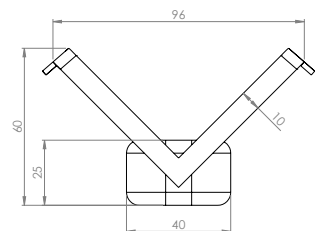

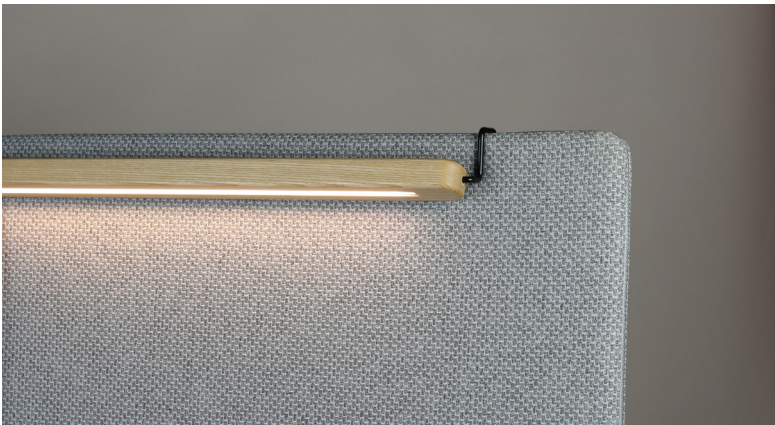

Woodlight is an effective and decorative lighting in white stained ash for A30 screens. The intensity of the light can be adjusted by a touch dimmer. Woodlight can also be angled for maximum effect.

## WOODLIGHT A30

Wood strip in white stained ash. Grey fabric cable. Tilttable and with touch dimmer on cable. Steel brackets painted in black or white. See drawing on web for exact measurements. Adhesive label included that shows where the switch is located when the cable is hidden.

### Woodlight A30

821164-2	L. 500	ash/black	295.32
821164-12	L. 500	ash/white	295.32
821165-2	L. 900	ash/black	328.19
821165-12	L. 900	ash/white	328.19
821166-2	L. 1300	ash/black	372.02
821166-12	L. 1300	ash/white	372.02
821167-2	L. 1800	ash/black	404.89
821167-12	L. 1800	ash/white	404.89

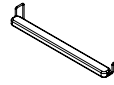

Watt: 12 W/m  
Lumens: 1200 lm/m  
Colour temp: 3000K  
LUX: max 230  
CRI: >80  
Beam angle: 120°

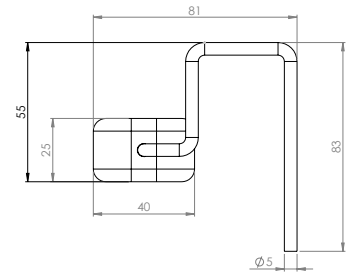

Led strip is mounted in the wooden rail, cable included.  
585 mm between LED and dimmer, 3100 mm between dimmer and drive.  
Europlug included.

Do not place the product in damp areas (outdoors/wet areas).

Assembly, (made by the customer on site): brackets are mounted on the sides of the product and hung on any A30 screen.



## NOON

The lamp has a swivel arm with adjustable head. Cord in the same colour as the lamp. Light source not included. (GU10 light source with max. 5W required)

### Noon 01

W. 348 H. 483 The base of the lamp is Ø. 162

821014	1 lamp	black	212,23
821015	1 lamp	white	212,23
821016	1 lamp	pink	212,23



### Noon 02

W. 624 H. 546 The base of the lamp is Ø. 229

821017	2 lamps	black	371,81
821018	2 lamps	white	371,81
821019	2 lamps	pink	371,81

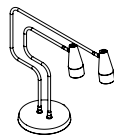

Noon 01



Noon 02



Noon 02

Work lighting in a unique design. Noon provides an even light to work in without dazzling or creating too strong contrasts with light from, for example, a ceiling lamp or other lighting. Noon is designed as an interior detail and fits just as well as a table lamp as a bedside lamp or lighting on a bookshelf. Available in two models, with one or two arms.



## FUNKIA LED LAMP

### Funkia LED lamp

Adjustable in 6 different light intensities and 4 different colour temperatures. With double USB ports (5V/2A). Has an unearthed plug, 1,5 m.

821006	black	174.26
821006-1	white	174.26

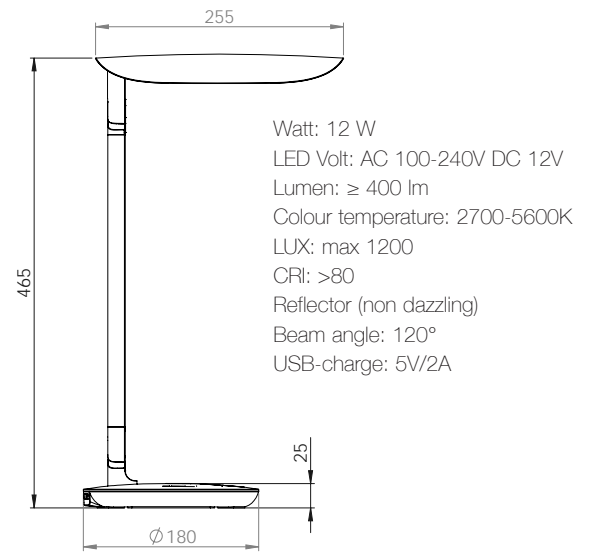

Funkia LED Lamp is a meeting between modern design and function where the matte black or white colour adds a stylish detail to the table. The joints at the top and bottom of the lamp allows you to regulate the lamp and the angle of the light after your wishes. With a simple touch, you can also adjust the light in 6 different intensities and 4 different colour temperatures.



## TULIP DESK LAMP LED

### Tulip Desk Lamp LED

Desk lamp with USB charger (0,7 A). Has an unearthed plug with 1,9 m cable.

821005	white/black	128.40
--------	-------------	--------

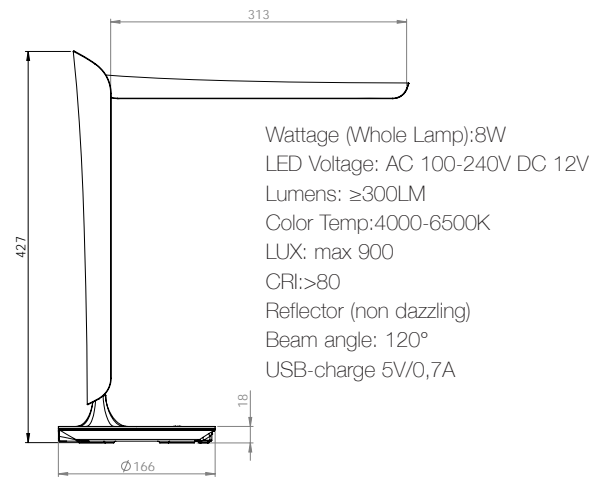

#### Tray for Tulip for A30

W. 172 H. 300 D. 65

637117-1 white -2 black

47.66



#### Tray for Tulip for Freewall

W. 172 H. 190 D. 30

671087-1 white -2 black

48.09

Very affordable, efficient and foldable desk lamp with LED lighting. Touch controls for dimming and colour temperature adjustment. USB port for charging mobile phone etc. Also available as an accessory for hanging on a toolbar rail or over our ScreenIT A30-products.



## A30 LIGHT

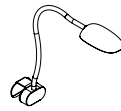

### A30 Light

Dimmable LED for mounting on A30 screen. Cable length 1,90 m with USB contact. Net adapter for wall socket included.

Watt: 4.5W.

Lumens max: 540Lm.

Colour temp: 4000K.

LUX max: 520lx at a height of 60 cm.

Lighting angle: 95 °.

637135-1

white

242.13

637135-3

silver

242.13

Lamp with screen mount for A30 screen. Add an A30 Light to your A30 screen - good lighting creates a better working environment. Hold down the on/off button to dim the light to the right brightness for you and your work tasks.



## TOOLBAR LIGHT



### Toolbar Light for rail

Cable length 1,90 m with USB contact. Net adapter for wall socket included.

Watt: 4,5W.

Lumen max: 540 lm.

Colour temp: 4000K.

LUX max: 520lx at a height of 60 cm.

Beam angle: 95°.

821060-1

white

253.51

821060-3

silver

253.51

Add a Toolbar Light to any of our rails.

## THE LIGHTNING FLOOR LAMP

### The Lightning Floor Lamp

Cable 3,5 m. Has an unearthed plug.

821050-1	See drawing	white	635.74
821050-2	See drawing	black	635.74

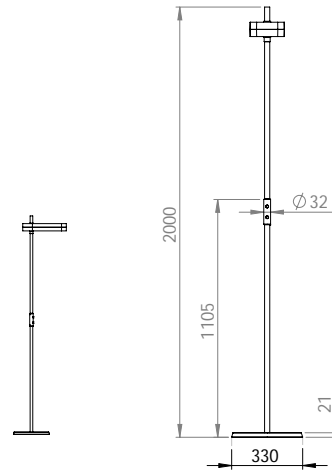
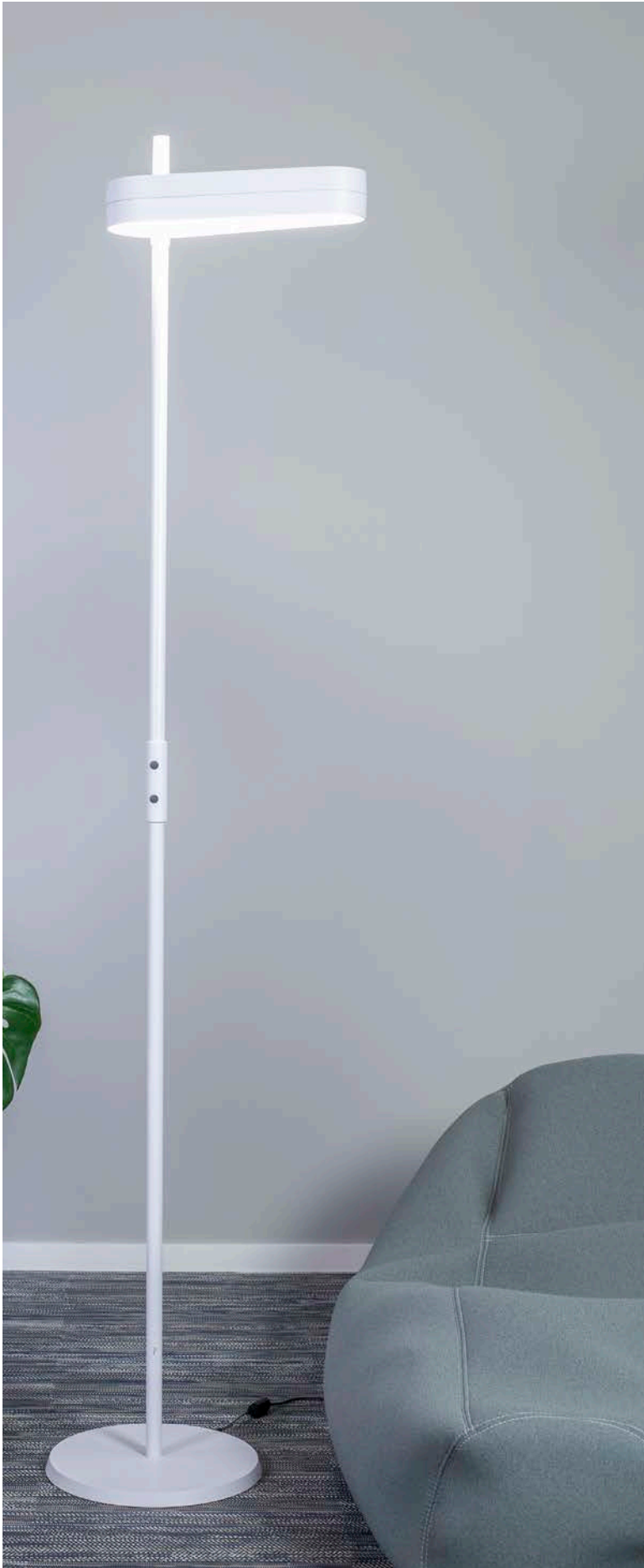

Wattage (Whole Lamp):30+30  
 LED Voltage: AC 100-240V DC 24V  
 Lumens: ≥4400lm  
 Color Temp:3500K  
 LUX: 1500/900/200 mm  
 CRI:>80  
 Beam angle: 120°

The Lightning is a floor lamp that suits all types of spaces. It has an uplight and a downlight function with touch buttons to adjust the light in three steps. The head is rotatable, allowing the beam to be directed in the desired direction, which improves the ergonomics. The LED module has a very long life span. With its clean expression and smart functions,



## THE LIGHTNING DESK LAMP

### The Lightning Desk Lamp

Can be mounted on the desk or in a Table Top with hole for a lamp. Drilled hole  $\varnothing$  25 mm. 3,5 m cable. Has an unearthed plug.

821055-1	See drawing	white	516.91
821055-2	See drawing	black	516.91

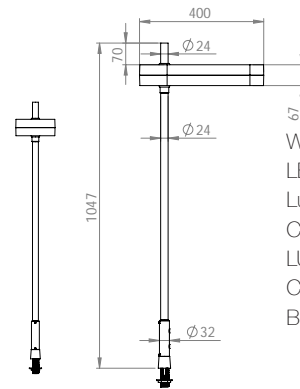

Wattage (Whole Lamp):30+30  
 LED Voltage: AC 100-240V DC 24V  
 Lumens:  $\geq$ 4400lm  
 Color Temp:3500K  
 LUX: 1500/900/200 mm  
 CRI:>80  
 Beam angle: 120°

The Lightning is an excellent choice. A modern LED module design with touch buttons for brightness adjustment in three different positions. LEDs have a long life span. Can be mounted directly in the desk or in a Table Top Slim. The advantage with mounting in a Table Top Slim is that it gives an easy access to an extra outlet. Also available as a floor model.



## TABLE TOP SLIM, WITH HOLE FOR THE LIGHTNING



### Table Top Slim, with hole for The Lightning

Table Top Slim with a hole suitable for The Lightning. 3 m extension cable included. 1 ext, 2 USB charge. Table cut out: 148x62 mm and drilled hole  $\varnothing$  25 mm.

821161-1		white	121.06
821161-2		black	121.06

The benefit of mounting in a Table Top Slim is that you easily get access to an extra electrical outlet.



Silent Pendant Lamp is a collection lamp shades, designed to be combined with a Silent Pendant Lamp. A molded lamp with thanks to its lamp shade, spreads a wonderful light and improves the acoustics of the room. The lamp screen is available in several colors and is nice to hang next to The Hut Lamp.

## LAMP SCREEN FOR SILENT PENDANT LAMP



### Lamp screen for Silent Pendant Lamp

*A molded lamp shade in felt. The lamp shade is available in several colours. The multi-coloured ones are stated outside/inside below. The pendant is purchased separately.*

821041	Ø 594	H. 200	dark grey	125.32
821042	Ø 594	H. 200	light grey	125.32
821043	Ø 594	H. 200	green/dark grey	125.32
821044	Ø 594	H. 200	blue/light grey	125.32





## LAMP FOR SILENT PENDANT LAMP

A simple pendant with a decorative, black textile cord with a copper base. A nice LED-lamp included.



### Lamp for Silent Pendant Lamp

5 m cord with E27 socket.

Lumens: 540 lm. Colour temp: 2300K. Watt: 8 W.

Mounting: two wires that need to be connected to a plug, otherwise connected to an electric system by an electrician.

W. 60 H. 176

821040

copper/black

80.64



## BRIGHT

A beautiful light source with a modern dimmable LED lamp and brass base. Bright works in our different The Hut constellations and is nicely combined with The Hut Lamp and Silent Pendant Lamp.

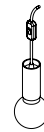

### Bright

5 m black textile-covered cord with switch and E27 socket.

Lumens: max 470 lm. Color temperature: 2700 K. Watt: 4 W.

Mounting: unearthed socket.

W. 95H. 210

821025

brass/black

187.77



## THE HUT LAMP

A simple and decorative ceiling pendant for a light bulb. The bracket is in copper with 5 m black textile cord and black switch. A stylish LED lamp included. The industrial lamp is part of The Hut Collection and is used to advantage in our various "houses" from that series. Read more about the collection in the chapter Room within a room.



### The Hut Lamp

5 m black textile-covered cord with switch and E27 socket. 3-step click attenuation, the light effect is easily changed by clicking on the switch.

Lumens: 70 lm, 350 lm, 700 lm. Color temperature: 2100 K. Watt: 4 W.

Mounting: earthed socket.

W. 60 H. 172

821020

copper/black

142.77





# MONITOR ARMS

Free up space, improve ergonomics, increase efficiency. A good monitor arm is an easy way to achieve major improvements. We have a wide selection of wall and desk arms for monitor screens in all environments – use everywhere from offices to hotels and conferences.



A stable, diverse and very affordable mechanical spring arm with ergonomic features for ideal office use. Weight span adjusted by a mechanical spring. Black cable holder with fishbone zip included. Three mounting options are included. ZAP can also be mounted on Toolbar, see chapter Toolbar.

## ZAP MONITOR ARM

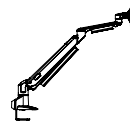

### ZAP

Monitor arm that is weight span adjusted by a mechanical spring. Adjustable in all positions.

615525	Weight span 1,5-7 kg/arm	silver	304.57
615525-1	Weight span 1,5-7 kg/arm	white	304.57
615525-2	Weight span 1,5-7 kg/arm	black	304.57

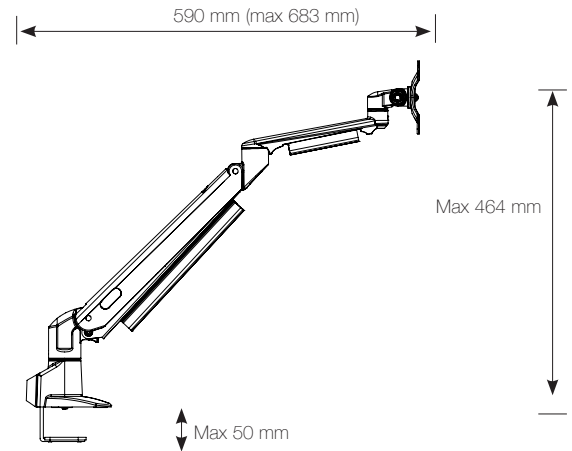

**Mounting options included:** Desk clamp, through desk, grommet hole 80 mm. For mount on toolbar, see chapter Toolbar.  
Reach Rotation 360 degrees. Tilt 180 degrees.

**VESA Monitor mount:** 75x75 and 100x100.

**Product weight:** Net weight 3,4 kg.



A double monitor arm with stylish design

## ZAP MONITOR ARM TWIN

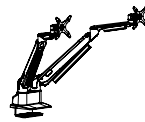

### ZAP Monitorarm Twin

Monitor arm that is weight span adjusted by a mechanical spring. Adjustable in all positions. Includes 2 arms and 1 pc of twin clamp.

618525	Weight span 1,5-7 kg/arm	silver	566.38
618525-1	Weight span 1,5-7 kg/arm	white	566.38
618525-2	Weight span 1,5-7 kg/arm	black	566.38

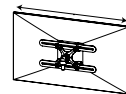

### VESA-adapter ZAP Twin

VESA adapter to adjust the screens sideways. The screens will always stay poem each other without changing the screen distance.  
Max weight / monitor 6 kg.

610610-2 W. 250	black	75.85
-----------------	-------	-------



A competitive priced monitor arm with both clamp and desk mount option in one. Suited for through desk mount (standard 80 mm) or with desk clamp. An important detail is the possibility to adjust each arm's height individually on the post for maximal flexibility.



V4 Twin is a complete set for two screens. Do you want to mount more screens? Choose the V4 Post 700 mm with several V4 Single Arm. Max weight capacity post 16 kg and max capacity per arm 8 kg. Each arm is individually height adjustable. Suited for through desk mount (standard 80 mm) or with desk clamp.

## V4 MONITOR ARM / V4 TWIN

### V4 Monitor arm

Max weight capacity monitor arm 8 kg. Desk clamp included. Max table thickness 65 mm. Also suited for through desk mount (standard 80 mm) and Ø 10 mm. Incl. VESA attachment standard 75 and 100, rotates 360° and is tiltable.

610710	H. 400	silver	166.28
610710-1	H. 400	white	166.28
610710-2	H. 400	black	166.28

### V4 TWIN

#### V4 Twin Complete

Max weight capacity 8 kg/arm. Desk clamp included. Max table thickness 65 mm. Also suited for through desk mount (standard 80 mm) and Ø 10 mm. Incl. VESA attachment standard 75 and 100, rotates 360° and is tiltable.

610763	H. 400	silver	290.74
610763-1	H. 400	white	290.74
610763-2	H. 400	black	290.74

### V4 COMPONENTS

#### V4 Post

Including desk clamp. Max weight capacity 16 kg.

610762	H. 700	silver	73.09
610762-1	H. 700	white	73.09
610762-2	H. 700	black	73.09

#### V4 Single arm without post

Max weight capacity 8 kg.

610716	L. 420	silver	124.47
610716-1	L. 420	white	124.47
610716-2	L. 420	black	124.47

#### VESA-adapter plate 200x100

Adapter VESA attachment plate. Fits all arms. For larger monitors.

610700	L. 200 W. 100	silver	32.23
--------	---------------	--------	-------

#### VESA-adapter 200x200

Adapter VESA attachment plate for 200x200 mm. Fits all arms.

610705	L. 200 W. 200	black	54.36
--------	---------------	-------	-------

#### Metal plate for angled edge desks

When the clamps need stable grip with angled edge. 1 clamp included.

66500	L. 100 W. 80	silver	24.47
-------	--------------	--------	-------

#### Telephone/client holder for monitorarm

To be mounted to a separate arm. Suits VESA 100.

671095	W. 230 H. 240	silver	46.17
671095-1	W. 230 H. 240	white	46.17
671095-2	W. 230 H. 240	black	46.17



A stable, diverse and very affordable gas spring arm with ideal ergonomic features for office use and wall mount for the home, hotel room or public spaces.

## D-ZINE MONITORARM

**D-Zine**  
*The gas arm adjusts to the weight of the screen. Adjustable in all positions. Rotate 360°. Tilttable 185°. 4 graphic inlays included.*

612525	Weight span 1,5-8,5 kg	silver	283.94
612525-1	Weight span 1,5-8,5 kg	white	283.94
612525-2	Weight span 1,5-8,5 kg	black	283.94
612526	Weight span 8-16 kg	silver	283.94
612526-1	Weight span 8-16 kg	white	283.94
612526-2	Weight span 8-16 kg	black	283.94

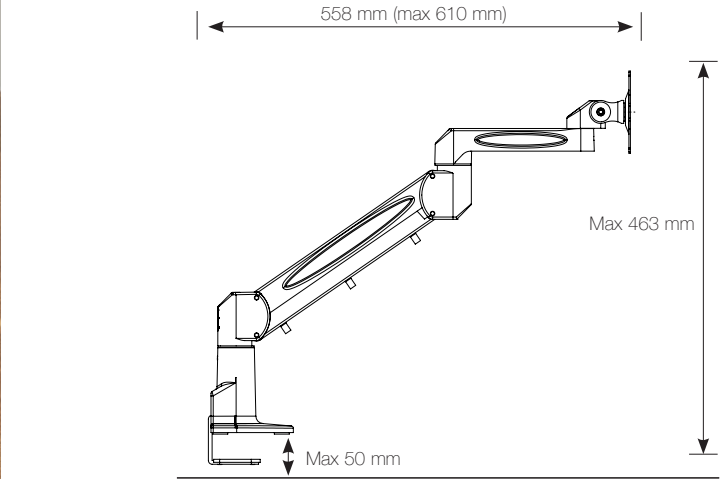

**Mounting options included:** Desk clamp, through desk, grommet hole 80 mm. For mount on toolbar, see the chapter Toolbar.

**Monitor mount VESA:** 75x75 and 100x100 is included.

**Product weight:** 3,4 kg.



## D-ZINE DOUBLE MONITORARM

### D-Zine Double Complete

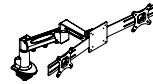

*D-Zine arm with Gotessons Double bracket. Maximum dimensions per screen 670 mm. Gotessons Double bracket weight 2 kg. Max weight each monitor, see below in brackets. 2 pcs VESA mount incl.*

613525	Weight span 1,5-8,5 kg (3 kg)	silver	357.98
613525-1	Weight span 1,5-8,5 kg (3 kg)	white	357.98
613525-2	Weight span 1,5-8,5 kg (3 kg)	black	357.98
613526	Weight span 8-16 kg (5 kg)	silver	357.98
613526-1	Weight span 8-16 kg (5 kg)	white	357.98
613526-2	Weight span 8-16 kg (5 kg)	black	357.98

### ACCESSORIES D-ZINE

#### Gotessons Double bracket

*For mounting two screen on D-zine. Max width 670 mm/monitor. Weight 2 kg. 2 pcs VESA mount incl.*

610504	L. 750	silver	74.04
610504-1	L. 750	white	74.04
610504-2	L. 750	black	74.04



#### Metal plate for angled edge desks

*When the clamps need stable grip with angled edge. 1 clamp included.*

66500	L. 100 W. 80	silver	24.47
-------	--------------	--------	-------

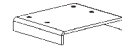

#### VESA-adapter plate 200x100

*Adapter VESA attachment plate. Fits all arms. For larger monitors.*

610700	L. 200 W. 100	silver	32.23
--------	---------------	--------	-------

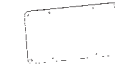

#### VESA-adapter 200x200

*Adapter VESA attachment plate for 200x200 mm. Fits all arms.*

610705	L. 200 W. 200	black	54.36
--------	---------------	-------	-------









# RECYCLING CPU / LAPTOP HOLDERS CABLE HOLDERS CABLE COLLECTORS

**C**PU/ laptop holders not only save space at the workstation, they are also equally practical and ergonomical. A full range of products in all shapes, sizes and budgets.

Cable clutter, not only aesthetically a nightmare, it also increases the risk of fire. Good cable management results in better hygiene and makes cleaning office spaces more efficient.





ReTurnIT+ is a flexible recycling module that is either mounted independently, against a wall or in a group of three. The soft-closing lids are attached with hinges. Assemble with a base plate and top plate. Choose whether you want adjustable feet or lockable wheels. As an option, there is also a top plate with a plant box where plants can be placed.

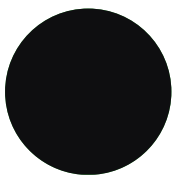

Colour: -2 black/brown  
(RAL 8022)

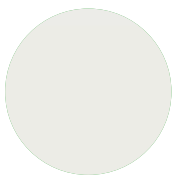

Colour: -18 cream white  
(RAL 9001)

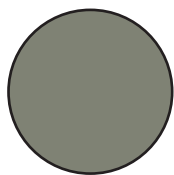

Colour: -21 grey green  
(RAL 7002)

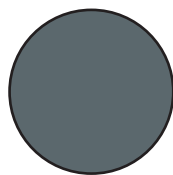

Colour: -22 grey blue  
(RAL 7043)

Re TurnIT + can also be obtained in other RAL on quotation. Minimum order quantity for special color is 10 pcs.



Feel free to combine with plants. Longifolia can, for example, be placed on the floor inside the cavity between the recycling stations.

We recommend the following plants:

- 160151 Mountain palm 900
- 160152 Yucca palm 700
- 160003 Violet ficus 1500
- 160076 Longifolia 2600.

## RE TURNIT +

### Re TurnIT +

Material: sheet metal. Volume: 125 litres.

The lid is attached with hinges.

With the option of adding plants with a maximum Ø of 200 mm.

The plant holder is adjustable.

With lockable wheels or floor stand.

### Re TurnIT +

Hinged lid. Material: sheet steel.

W. 608 D. 336

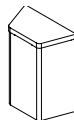
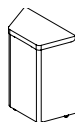

620085-2 with wheels H. 854

620085-18 with wheels H. 854

620085-21 with wheels H. 854

620085-22 with wheels H. 854

630085-2 with feet H. 818

630085-18 with feet H. 818

630085-21 with feet H. 818

630085-22 with feet H. 818

black brown 690.96

cream white 690.96

grey green 690.96

grey blue 690.96

black brown 621.81

cream white 621.81

grey green 621.81

grey blue 621.81

### Re TurnIT + top waste

Hinged lid. Material: sheet steel.

W. 608 D. 336

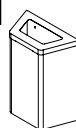
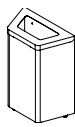

620086-2 with wheels H. 854

620086-18 with wheels H. 854

620086-21 with wheels H. 854

620086-22 with wheels H. 854

630086-2 with feet H. 818

630086-18 with feet H. 818

630086-21 with feet H. 818

630086-22 with feet H. 818

black brown 690.96

cream white 690.96

grey green 690.96

grey blue 690.96

black brown 621.81

cream white 621.81

grey green 621.81

grey blue 621.81

### Re Turnit waste bags

125 L.

610282

Rolls/25 units 20.00

### Re Turnit Damp Collector

Material: soft ABS-plastic. Waterproof.

610084 W. 524 H. 490 D. 253

black 101.70

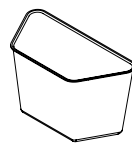

Re Turnit Damp collector is a container for the recycling module Re Turnit. The container is placed at the bottom to collect moisture and liquid, must be used with a litter bag. It is easily cleaned and by using it you create a more hygienic recycling.

1 pc of each label (total 5 pcs) is included per purchase of Re Turnit. The labels are always round and only available with white text against grey background. Size: Ø 180 mm.





## RE TURNIT +

### Re TurnIT + top can

Hinged lid. Material: sheet steel.  
W. 608 D. 336

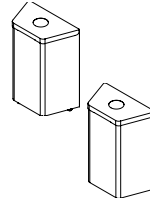

620087-2	with wheels	H. 854	black brown	690.96
620087-18	with wheels	H. 854	cream white	690.96
620087-21	with wheels	H. 854	grey green	690.96
620087-22	with wheels	H. 854	grey blue	690.96
630087-2	with feet	H. 818	black brown	621.81
630087-18	with feet	H. 818	cream white	621.81
630087-21	with feet	H. 818	grey green	621.81
630087-22	with feet	H. 818	grey blue	621.81

### Re TurnIT + top paper

Hinged lid. Material: sheet steel.  
W. 608 D. 336

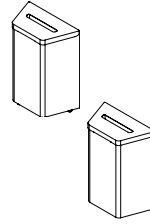

620088-2	with wheels	H. 854	black brown	690.96
620088-18	with wheels	H. 854	cream white	690.96
620088-21	with wheels	H. 854	grey green	690.96
620088-22	with wheels	H. 854	grey blue	690.96
630088-2	with feet	H. 818	black brown	621.81
630088-18	with feet	H. 818	cream white	621.81
630088-21	with feet	H. 818	grey green	621.81
630088-22	with feet	H. 818	grey blue	621.81

### Re TurnIT + top shelf

Material: sheet steel. Must be combined with three Re TurnIT+. The top plate is mounted using two connecting triangles and the included screw.  
H. 16 D. 525 L. 605

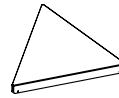

620092-2	black brown	148.40
620092-18	cream white	148.40
620092-21	grey green	148.40
620092-22	grey blue	148.40

### Re TurnIT + top shelf for plant

Material: sheet steel. Must be combined with three Re TurnIT+. The top plate is mounted using two connecting triangles and the included screw. Adjustable holder for plant included, 210-400 mm.  
H. 16 D. 525 L. 605

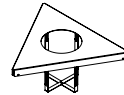

620093-2	black brown	190.96
620093-18	cream white	190.96
620093-21	grey green	190.96
620093-22	grey blue	190.96



Assembly: Floor feet are fully assembled upon delivery. Wheels are assembled by the customer. When mounting on a wall, use the appropriate screw, not included. Connection of three modules takes place with the help of two different triangle details, assembled by the customer.



A rotating recycling station which takes little space underneath your desk. Built on a rotating system with removable containers for paper and other materials. Comes in silver, black or white.

## SETUPIT WITH ROTATABLE POST

### SetUpIT

1 rotatable metal post, 1 plastic container for paper and for other materials. Includes mounting screws.

W. 255 H. 460 D. 290

610070	black	97.98
610071	silver grey	97.98
610072	white	97.98

W. 255 H. 460 D. 440

610570*	black	130.96
610571*	silver grey	130.96
610572*	white	130.96

\*with runner



### SetUpIT with lid

1 rotatable metal post, 1 plastic container for paper and 1 for other materials with lid. Includes mounting screws.

W. 255 H. 460 D. 297

610073	silver grey	110.74
610074	black	110.74
610076	white	110.74

W. 255 H. 460 D. 440

610573*	silver grey	143.94
610574*	black	143.94
610576*	white	143.94

\*with runner

### Height distances



871003	H. 65	silver	18.09/2pcs
871003-1	H. 65	white	19.79/2pcs
871003-8	H. 65	black	19.79/2pcs

### Plastic bags for the small container

610252	Rolls/320 units	silver	7.13
--------	-----------------	--------	------

### Bags for the small container

100% biodegradable.

610272	Rolls/25 units	transparent	8.72
--------	----------------	-------------	------



## HALFMOON ROTATABLE PEN DRAWER

The drawer is mounted under the desk top. Contains several small sections and tape holder.



### Halfmoon rotatable pen drawer

Rotatable pen drawer with sections and holder for tape. External dimension.

651060	W. 340	H. 35	D. 197	silver	24.57
651060-2	W. 340	H. 35	D. 197	black	24.57



## FLOOR/WALL CABLE COLLECTOR ALUMINIUM



### Floor Cable Collector aluminium

Floor canal system made of aluminium, screwed or taped to the floor. Can be ordered in any length. Contact us for price.

732080	L. 800	W. 155	H. 17	silver	75.96
732120	L. 1200	W. 155	H. 17	silver	113.83
732160	L. 1600	W. 155	H. 17	silver	151.81
732200	L. 2000	W. 155	H. 17	silver	189.89
732300	L. 3000	W. 155	H. 17	silver	284.89



## FLOOR CABLE COLLECTOR TPE



### Floor cable collector TPE

Price/metre, easy to cut. Order tape separately.

730000	W. 78	H. 17	grey	36.17/m
--------	-------	-------	------	---------

### Tape

Self adhesive tape for floor cable collectors. Consumption 2 pcs/floor cable collector.

731000	transparent	5.00/m
--------	-------------	--------



## LAPTOP LOCKABLE DRAWER

### Laptop lockable draw

Thin metal lockable drawer with felt inlay to be mounted under the desk for laptop no bigger than 400x300 mm.

Not suitable with Gotessons height distances.

Inner dimensions.

651070	W. 400	H. 64	D. 300	silver	202.87
651070-1	W. 400	H. 64	D. 300	white	202.87

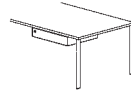

## PULL-OUT PEN DRAWER WITH LOCK

Thin metal pencil drawer with mat to be mounted under the desk. External dimensions.

### Narrow pull-out pen drawer Mini with lock

650079-1	W. 144	H. 51	D. 265	white	112.55
650079-3	W. 144	H. 51	D. 265	silver	112.55



### Narrow pull-out pen drawer with lock

650049-1	W. 144	H. 51	D. 400	white	114.15
650049-3	W. 144	H. 51	D. 400	silver	114.15

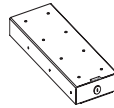

### Height distances

871003	H. 65	silver	18.09/2pcs
871003-1	H. 65	white	19.79/2pcs
871003-8	H. 65	black	19.79/2pcs



Drawers below can not be mounted on SetUpIT. Plastic insert included.

### Pen drawer with lock Big

651069	W. 393	H. 55	D. 247	silver	121.60
651069-1	W. 393	H. 55	D. 247	white	121.60
651069-2	W. 393	H. 55	D. 247	black	121.60



### Pen drawer with lock Small

651059	W. 319	H. 54	D. 187	silver	115.11
651059-1	W. 319	H. 54	D. 187	white	115.11
651059-2	W. 319	H. 54	D. 187	black	115.11





## TWISTIT



### TwistIT

Twistable and rotatable holder for laptops and small CPU:s, with or without docking station. Does not need runner/slide.

Recommended max weight 5 kg, 10 kg as permanent vertical position.

W. 350 H. 350

551031		silver	172.45
551031-1		white	189.68
551031-8		black	189.68

### TwistIT with runner and distances

W. 350 H. 350

551030	440 mm runner	silver	207.98
551030-1	440 mm runner	white	229.15
551030-8	440 mm runner	black	229.15

### TwistIT Big

W. 380 H. 400

551033		silver	226.28
551033-1		white	248.62
551033-8		black	248.62

### TwistIT Big with runner and distances

W. 380 H. 400

551032	440 mm runner	silver	260.64
551032-1	440 mm runner	white	286.91
551032-8	440 mm runner	black	286.91

Twistable and rotatable holder for laptops with or without dockingstation. Takes minimum space underneath the desk, does not need runner/ slide and can be used horizontally and vertically. The vertical/horizontal tightness can be adjusted by hand.



## TURNIT



### TurnIT Client holder

Mounted under the desk.

Computer/client is attached with 2 straps, included.

W. 125.5 H. 31 D. 220

870308-1		white	40.00
870308-3		silver	40.00
870308-8		black	40.00

Simple holder for small clients/CPU:s.





Rotatable by 360° and with the ability to slide underneath your desk to the preferred position. Suits all computers on the market. Mounts on a runner.

## SWINGIT

### SwingIT

Suits both tower and desktop models.  
W. 212 D. 300

871010	with runner/distances	silver	141.60
871005	without runner	silver	105.74

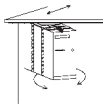

Simple, functional and designed holder that suits most computers.

## ANYWAY

### Anyway

Fits tower model, width adjustable from 80-220 mm, height adjustable from 270-550 mm.

650000	without runner	silver	124.57
650000-1	without runner	white	137.23
650000-2	without runner	black	137.23

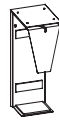

Simple model with easy and quick installation. Suits both tower and desktop models.

## CPU HOLDER 1

### CPU holder 1

2 flat metal profiles, 2 straps (L. 1700 mm), mounting kit.  
W. 60 H. 71 D. 405

872300	tower model/desktop model	silver	58.83
--------	---------------------------	--------	-------

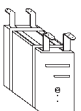

Only suits tower models. Slidable and rotatable. Adjustable in heights.

## STAND

### Stand CPU holder

W. 150 H. 330-540 D. 135

877000	without runner	silver	105.74
--------	----------------	--------	--------

### Height distances

871003	H. 65	silver	18.09/2pcs
871003-1	H. 65	white	19.79/2pcs
871003-8	H. 65	black	19.79/2pcs





## BRINGIT LAPTOP BAG



### BringIT Laptop Bag

Laptop bag in felt material with compartment on the outside, one divider in the middle on the inside and 2 compartments inside.

W. 380 H. 310 D. 110

640086

black 145.43

BringIT is a storage bag in black felt material with practical compartments for your laptop, folders and personal belongings. The bag is perfect for the activity-based office, you can easily transport all your belongings in a smooth way. Carry the computer with you in the bag to the meeting room, office or hang it at the workplace on a hook, purchased separately. Made from 100 % recyclable polyester.

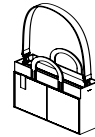

### BringIT + storage bag

Laptop bag in felt material with compartment on the outside, one divider in the middle on the inside and two compartments inside. Shoulder strap and two handles. With zipper.

W. 380 H. 310 D. 110

640087

black 172.55



### Hook with screws

Hook to be mounted under the desk. Screws included.

W. 40 H. 53 D. 58

671088-1

white 14.89

671088-2

black 14.89

671088-3

silver 14.89

BringIT + with both a carrying handle and a removable shoulder strap. Unlike our first Bring IT, the + model also has a zipper, which makes it extra reliable. .



Produced for a very quick and easy assembly. Saves both time and money and most importantly, a perfect cable solution at your desk.

## HALFPIPE COMPLETE



### Halfpipe complete

1 cable holder Halfpipe with 2 mounting ladders, 2 plastic ends, 6-way junction box (3 m), 1 network cable Cat.6 (5 m), 1 RJ12 phone cable (5 m), 1 G-clip. All cables are assembled in the Cable Collector Ø 22.

745049	L. 490	W. 170	D. 80	silver	142.77
745049-1	L. 490	W. 170	D. 80	white	157.02
745049-8	L. 490	W. 170	D. 80	black	157.02
745079	L. 790	W. 170	D. 80	silver	150.74
745079-1	L. 790	W. 170	D. 80	white	165.74
745079-8	L. 790	W. 170	D. 80	black	165.74
745115	L. 1150	W. 170	D. 80	silver	164.47
745115-1	L. 1150	W. 170	D. 80	white	181.17
745115-8	L. 1150	W. 170	D. 80	black	181.17
745150	L. 1500	W. 170	D. 80	silver	190.74
745150-1	L. 1500	W. 170	D. 80	white	209.57
745150-8	L. 1500	W. 170	D. 80	black	209.57
745170	L. 1700	W. 170	D. 80	silver	197.55
745170-1	L. 1700	W. 170	D. 80	white	217.55
745170-8	L. 1700	W. 170	D. 80	black	217.55



### Halfpipe plastic end

Injection-moulded plastic. Closes of the side. Not for 770100 and 771100.

740020				silver	8.94
740020-1				white	8.94
740020-2				black	8.94

### Assembly hook for Halfpipe

Makes it easier to assemble Halfpipe single handedly. One is enough for mounting several Halfpipes.

740010				black	14.15
--------	--	--	--	-------	-------



### G-clips

For mounting cables under the desk. 5 clips/package.

700240-1	W. 20			white	11.38
700240-2	W. 20			black	11.38
700240-3	W. 20			silver	11.38
700242-1	W. 40			white	12.87
700242-2	W. 40			black	12.87
700242-3	W. 40			silver	12.87



Available in more combinations. Contact Gotessons for more information.

## COMPLETE SET



### Complete set

6-way junction box 3 m cable, 5 m net, 5 m tel. Fits all cable holders. All cables are assembled in the Cable Collector Ø 22.

700900	3 m cable, 5 m net, 5 m tele			silver	89.26
700900-1				white	89.26
700900-2				black	89.26
700905	As 700900 with 5 m cable			silver	130.21
700930	With 1x3, 1x6 sockets			silver	108.72

### Complete set 1,5 m

Fits all cable holders. All cables are assembled in the Cable Collector Ø 22.

700903-1	1,5 m cable, 2 m net, 2 m tele			white	68.51
700903-2				black	68.51
700903-3				silver	68.51



## TURNABLE JUNCTION BOX

Can easily be mounted on or under the desk or in the Gotessons cable holder for conferences. Adjustable 360°. Protects against electrical overload and risk of overheating. Also available with desk clamp.

### Turnable extensions

Fixed with screw under or above desktop. On and off button.  
Length: 4 way 290 mm, 6 way 380 mm.

700420	4-way earthed, 3 m cable	white/black	40.96
700421	6-way earthed, 3 m cable	white/black	48.51

### Turnable junction box with desk clamp

Desktop thickness max 50 mm. On and off button.  
Length: 4 way 290 mm, 6 way 380 mm.

700424	4-way earthed, 3 m cable	white/black	55.53
700425	6-way earthed, 3 m cable	white/black	63.40



## JUNCTION BOX EARTHED WITH USB CHARGING

### Junction box earthed with USB charging

721815	3-ways, 2USB, 1,5 m cable	black	26.70
--------	---------------------------	-------	-------



## JUNCTION BOX, 3-WAYS EARTHED



### Junction box earthed

700330	3-ways earthed, 1,5 m cable	white	11.38
700333	3-ways earthed, 3 m cable	white	14.79
700410	3-ways earthed, 5 m cable	white	16.06
694500	6-ways earthed, 3 m cable	white	16.06
694550	6-ways earthed, 5 m cable	white	19.79



## HALFPIPE CABLE HOLDER

### Halfpipe cable holder

*In cupular aluminium with adjustable turning function that allows easy cable access. Spacious, hiding large amounts of cables.*

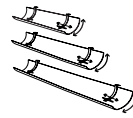

740049	L. 490	W. 170	D. 80	silver	48.19
740049-1	L. 490	W. 170	D. 80	white	53.09
740049-8	L. 490	W. 170	D. 80	black	53.09
740079	L. 790	W. 170	D. 80	silver	55.53
740079-1	L. 790	W. 170	D. 80	white	61.17
740079-8	L. 790	W. 170	D. 80	black	61.17
740115	L. 1150	W. 170	D. 80	silver	69.79
740115-1	L. 1150	W. 170	D. 80	white	76.38
740115-8	L. 1150	W. 170	D. 80	black	76.38
740150	L. 1500	W. 170	D. 80	silver	94.89
740150-1	L. 1500	W. 170	D. 80	white	104.68
740150-8	L. 1500	W. 170	D. 80	black	104.68
740170	L. 1700	W. 170	D. 80	silver	101.06
740170-1	L. 1700	W. 170	D. 80	white	111.49
740170-8	L. 1700	W. 170	D. 80	black	111.49

### Cable holder Halfpipe adjustable

*W. 170 D. 80 L:1000-1800 mm*

740100	silver	103.72
740100-1	white	114.15
740100-8	black	114.15

Available in several different lengths. The adjustable mounting attachments and low weight makes assembly quick and easy.



## HALFPIPE ADJUSTABLE WITH KEYHOLE FOR DESKS

### Halfpipe adjustable with keyhole for desks

*To be mounted with screws under the desk, 2 pcs in one pack. W. 170 D. 80 L:1000-1800 mm*

771100	silver	128.94
--------	--------	--------



### Desk mount set for Halfpipe with keyhole

*To be mounted with screws under the desk, 2 pcs in one pack.*

642065-3	silver	66.81
----------	--------	-------

Halfpipe with keyhole mount for easier assembly.



## BI-BOX

Bi-Box is a lateral openable lid and cable box in one. The lid can easily be opened in both directions. Soft close function. Add separate Power Inlay. See video at [www.gotessons.com](http://www.gotessons.com). Bi-Box is available in two sizes. The table cut out hole are the same as Gotessons Power Box.

### Bi-Box small

*Bi lateral openable lid and cable box in one. Table cut out 286x135 mm. W. 150 L. 300 D. 118*

721000	silver	-1 white -2 black -4 copper	150.85
--------	--------	-----------------------------	--------

### Bi-Box large

*Bi lateral openable lid and cable box in one. Table cut out 592x135 mm. W. 150 L. 605 D. 118*

721001	silver	-1 white -2 black -4 copper	272.23
--------	--------	-----------------------------	--------



## POWER INLAY

### Power Inlay for Bi-Box small

*Easy to mount with screws, in to the bottom of the Bi-Box. Suitable for Bi-Box small. 3 m extension cable included.*

721002	3 ext, 2 net	black	82.66
721003	2 ext, net, VGA, audio, HDMI	black	120.43
721007	1 ext, net, VGA, audio, HDMI, USB data	black	116.91
721008	2 ext, 2 net, USB charge	black	116.91
721010	2 ext, HDMI, USB C data	black	86.81

### Power Inlay for Bi-Box large

721002	3 ext, 2 net	black	82.66
721003	2 ext, net, VGA, audio, HDMI	black	120.43
721004	4 ext, 4 net, 4 USB Data	black	173.40
721005	4 ext, net, VGA, audio, HDMI	black	165.85
721006	4 ext, 4 net, VGA, audio, HDMI, USB data	black	188.62
721007	1 ext, net, VGA, audio, HDMI, USB data	black	116.91
721008	2 ext, 2 net, USB charge	black	116.91
721009	5 ext, net, HDMI, 4 USB charge	black	205.85
721010	2 ext, HDMI, USB C data	black	86.81
721011	4 ext, HDMI, USB C data	black	108.30



## CABLE HOLDER FOR CONFERENCE TABLES

Cable holder suitable for the Power Box. Foldable ends for optimal suitability.

### Cable holder for Conference table

*Cable holder adapted for the Power Box Single, with foldable ends for optimum suitability. Made from sheet-metal. Width bottom: 130 mm. Top 270 mm.*

720000-1	L. 660	W. 130-270	D. 141	white	81.28
720000-2	L. 660	W. 130-270	D. 141	black	81.28
720000-3	L. 660	W. 130-270	D. 141	silver	74.57
720010-1	L. 290	W. 130-270	D. 141	white	56.49
720010-2	L. 290	W. 130-270	D. 141	black	56.49
720010-3	L. 290	W. 130-270	D. 141	silver	51.70

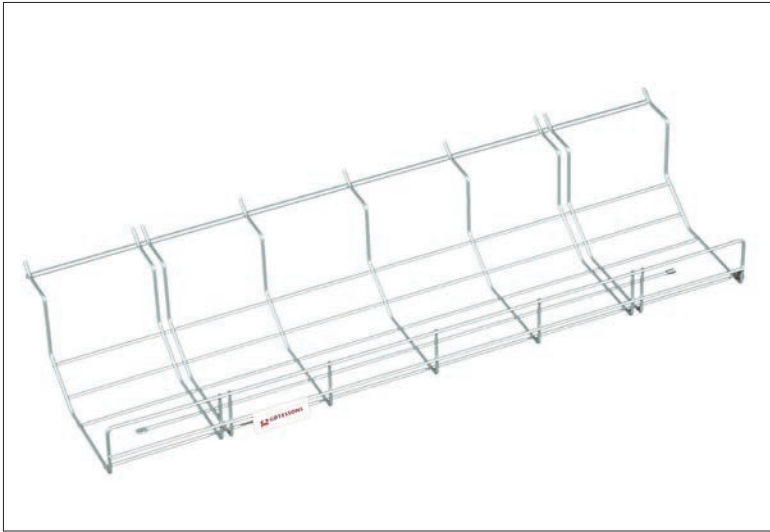

## QUICK CABLE HOLDER

Designed for mounting straight underneath the desk, suitable for installation under desks with visitor seats etc. Available in two lengths. Easy installation.

### Quick cable holder

687548-2	L. 480	W. 95	D. 80	black	23.51
687548-3	L. 480	W. 95	D. 80	silver	23.51
687573-2	L. 730	W. 95	D. 80	black	25.32
687573-3	L. 730	W. 95	D. 80	silver	25.32

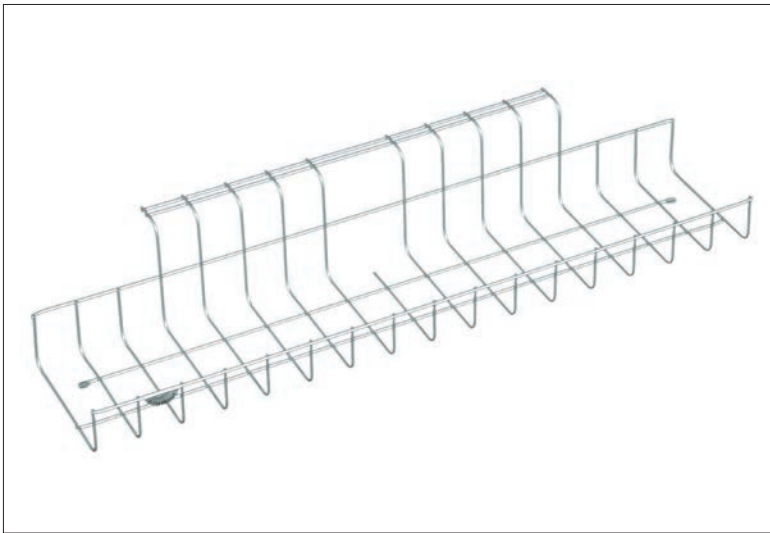

## G-49 AND G-79 CABLE HOLDER

Allowing cables to be routed the shortest way to your equipment. Free passage for full cover age installation beneath the steel/wood structure of your desk.

### G-49 and G-79 cable holder

621080-2	L. 490	W. 105	D. 85	black	19.57
621080-3	L. 490	W. 105	D. 85	silver	19.57
621081-2	L. 790	W. 105	D. 85	black	30.53
621081-3	L. 790	W. 105	D. 85	silver	30.53

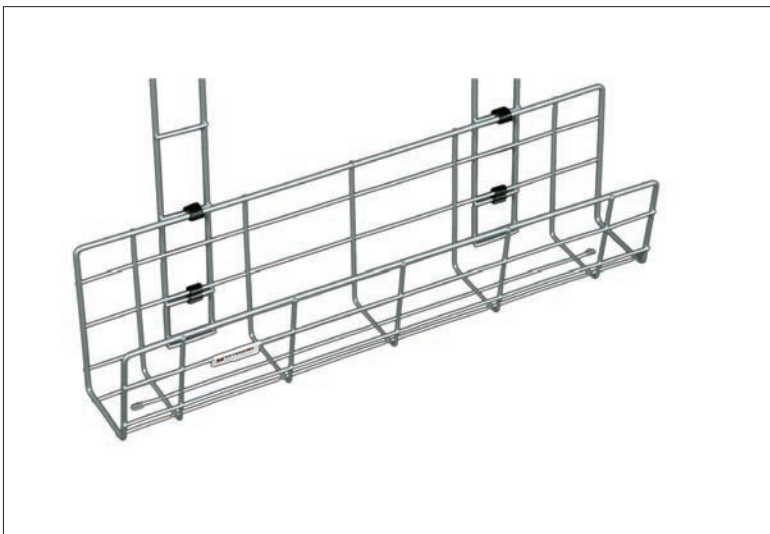

## CABLECARE CABLE HOLDER

Protected cable collection holder with a flexible system allowing holders to be connected in series to any length, for high or low mounting.

### CableCare Cable holder

700250-2	L. 490	W. 105	D. 145	black	24.47
700250-3	L. 490	W. 105	D. 145	silver	24.47
700280-2	L. 790	W. 105	D. 145	black	26.38
700280-3	L. 790	W. 105	D. 145	silver	26.38

### Mounting ladder

700237-2	L. 360	W. 45		black	5.21
700237-3	L. 360	W. 45		silver	5.21

### CableCare holder value pack

2 cable holders, 4 mounting ladders, installation kit.

700150-2	L. 490	W. 105	D. 145	black	51.06
700150-3	L. 490	W. 105	D. 145	silver	51.06
700180-2	L. 790	W. 105	D. 145	black	53.40
700180-3	L. 790	W. 105	D. 145	silver	53.40



## CABLE COLLECTOR Ø 22

Flexible plastic collector for cables, to be opened and closed with a simple tool.

### Cable Collector

110050	Inner dimension Ø 22	black	15.43/m
110051	Inner dimension Ø 22	silver	15.43/m
110052	Inner dimension Ø 22	white	15.43/m

### Sladdslukare 20 m

110070	Inv.mått Ø 22 mm	svart	151.81
110071	Inv.mått Ø 22 mm	silver	151.81
110072	Inv.mått Ø 22 mm	vit	151.81

### Tool for cable collector Ø 22

For cable collector Ø 22

110055	grey	11.17
--------	------	-------

### Cable Collector value pack

2,5 m cable collector Ø 22 + tool.

110060	silver	36.49
--------	--------	-------

### Cable Collector Mini

110061	Inner dimension Ø 14	black	14.36/m
--------	----------------------	-------	---------

### Tool for cable collector Mini Ø 14

For cable collector Ø 14

110065	blue	11.17
--------	------	-------



## CABLE COLLECTOR IN FABRIC WITH ZIP

### Cable collector in fabric with zip

Cable Collector sealed with zipper.

110081	L. 3 m, black fabric, black zip	Ø 25	30.11
110083	L. 3 m, white fabric, white zip	Ø 25	30.11
110089	L. 1,5 m, black fabric, black zip	Ø 25	24.57
110090	L. 1,5 m, white fabric, white zip	Ø 25	24.57

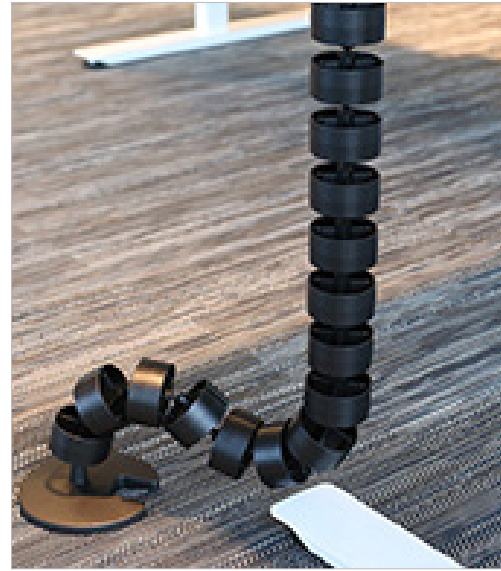

## CABLE COLLECTOR

Collects cables from desk to floor, wall or ceiling. Flexible plastic construction.

### Cable Collector

Delivered with mount for floor and ceiling/wall.

107558-2	L. 780 (15 sections) Ø 65	black	65.21
107558-3	L. 780 (15 sections) Ø 65	silver	65.21
107559-2	L.1230 (24 sections) Ø 65	black	82.02
107559-3	L.1230 (24 sections) Ø 65	silver	82.02
107560-2	Single section Ø 65	black	3.51
107560-3	Single section Ø 65	silver	3.51



## CABLE COLLECTOR PET

### Cable collector PET

Cable collector in 100% polyester. Closes itself.

110073	Ø 25	L. 25 m	white	355.74
110074	Ø 25	L. 25 m	black	355.74
110075	Ø 25	L. 25 m	silver	355.74

110085	white	110086	black	110087	silver	15.32/m
--------	-------	--------	-------	--------	--------	---------



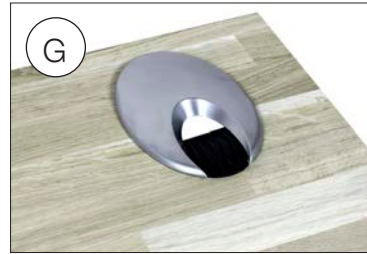

## CABLE GROMMETS

<b>A</b>	<b>Cable grommet plastic</b> <i>Table cut out Ø 60.</i>	
	700303-1 white -2 black -3 silver	4.26
<b>B</b>	<b>Cable grommet zinc</b> <i>Table cut out Ø 63.</i>	
	700293 mat chrome	14.26
	700294 chrome	14.26
<b>C</b>	<b>Cable grommet plastic</b> <i>Table cut out Ø 80.</i>	
	700288-1 white -2 black -3 silver	4.26
<b>D</b>	<b>Cable grommet with brush</b> <i>Table cut out Ø 80.</i>	
	700295 silver -2 black	12.13
<b>E</b>	<b>Cable grommet chrome plastic</b> <i>Table cut out Ø 80.</i>	
	700291 chrome	9.68
<b>F</b>	<b>Cable grommet zinc</b> <i>Table cut out Ø 79</i>	
	700301-1 chrome -1 nickel -2 matte chrome -4 white	12.87
<hr/>		
	<b>Circular saw</b>	
	699200 Ø 64	90.96
	699300 Ø 79	90.96
	699400 Ø 80	106.91
<hr/>		

## CABLE GROMMET OVAL

<b>G</b>	<b>Cable grommet zinc oval</b> <i>Table cut out Ø 80.</i>	
	700302 chrome -1 nickel -2 matte chrome	8.83
<hr/>		

We have a wide range of cable grommets. For all models, see [www.gotessons.com](http://www.gotessons.com).





# ELECTRICAL ACCESSORIES

Vibrant business rooms, quiet IT rooms, creative rooms, hotel rooms or conference rooms. Regardless of the environment, we offer the appropriate solution for much needed access connections or recharging. Regardless of connections and technologies, we solve your needs.



A stylish and practical electrical outlet that can be used in a variety of environments. Powerport is spring-loaded and opens with a simple push. With two led lights on the sides that you turn on by a touch button in open position. Holding down the button changes the brightness. Dimming with memory function. With USB-A, USB-C and two power outlets.



## POWERPORT

### Powerport

*LED lighting with touch control. Mounted in Ø 102 mm hole. Fits desk thickness up to 55 mm. Builds 365 mm under desk. 1.1 m cable. Grounded electrical outlet.*

690040	2 extensions, USB A+C charge	black	339,89
690040-FR	2 extensions FR, USB A+C charge	black	339,89



## BI-BOX

### Bi-Box small

Bi lateral openable lid and cable box in one.

Table cut out 286x135 mm.

W. 150 L. 300 D. 118

721000 silver -1 white -2 black -4 copper

150.85

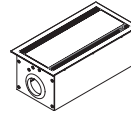

### Bi-Box large

Bi lateral openable lid and cable box in one.

Table cut out 592x135 mm. W. 150 L. 605 D. 118

721001 silver -1 white -2 black -4 copper

272.23

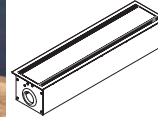

Bi-Box is a lateral openable lid and cable box in one. The lid can easily be opened in both directions. Soft close function. Add separate Power Inlay. See video at [www.gotessons.com](http://www.gotessons.com). Bi-Box is available in two sizes. The table cut out hole are the same as Gotessons Power Box.



All Power Inlay delivered with short cables. See page 225 for cable extension.

## POWER INLAY

### Power Inlay for Bi-Box Small

Easy to mount with screws, in to the bottom of the Bi-Box. Suitable for Bi-Box small. 3 m extension cable included.

721002 3 ext, 2 net black 82.66

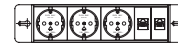

721003 2 ext, net, VGA, audio, HDMI black 120.43

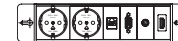

721007 1 ext, net, VGA, audio, HDMI, USB data black 116.91



721008 2 ext, 2 net, USB charge black 116.91



721010 2 ext, HDMI, USB C data black 86.81



### Power Inlay for Bi-Box Small and Large

Easy to mount with screws, in to the bottom of the Bi-Box. Suitable in Bi-Box large. 3 m extension cable included.

721004 4 ext, 4 net, 4 USB data black 173.40

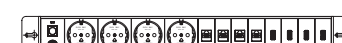

721005 4 ext, net, VGA, audio, HDMI black 165.85

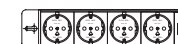

721006 4 ext, 4 net, VGA, audio, HDMI, USB data black 188.62



721009 5 ext, net, HDMI, 4 USB charge black 205.85



721011 4 ext, HDMI, USB C data black 108.30



721022 Net adapter USB A+C to Power Inlay black 56.81  
Suits Power Inlay 721010+721011.

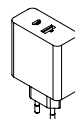

697502 Desk mount for Power Inlay black 29.47/2 pcs  
To mount Power Inlay in desk top or in a existing hole.



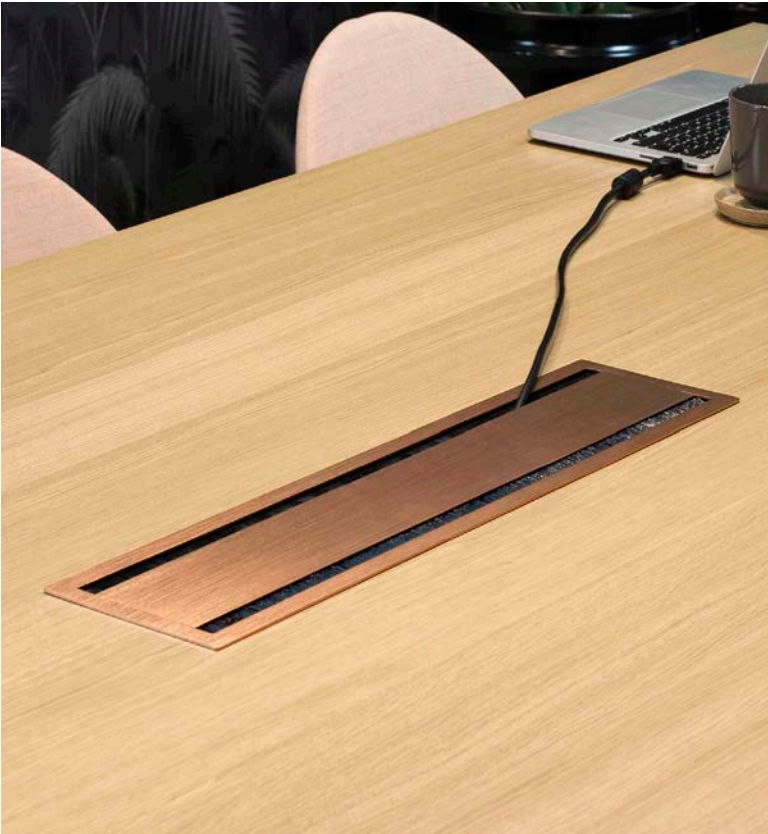

Bi-Lid is an openable lid that is easily opened both ways for easy access to e.g. cables beneath the table.

## BI-LID

Bi-Lid is an openable lid that is easily opened both ways for easy access to e.g. cables beneath the table.

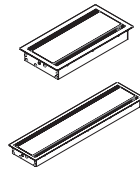

### Bi-Lid Small

W. 150 L. 300 D. 42

721200 silver -1 white -2 black -4 copper

124.36

### Bi-Lid Large

W. 150 L. 605 D. 42

721201 silver -1 white -2 black -4 copper

192.13

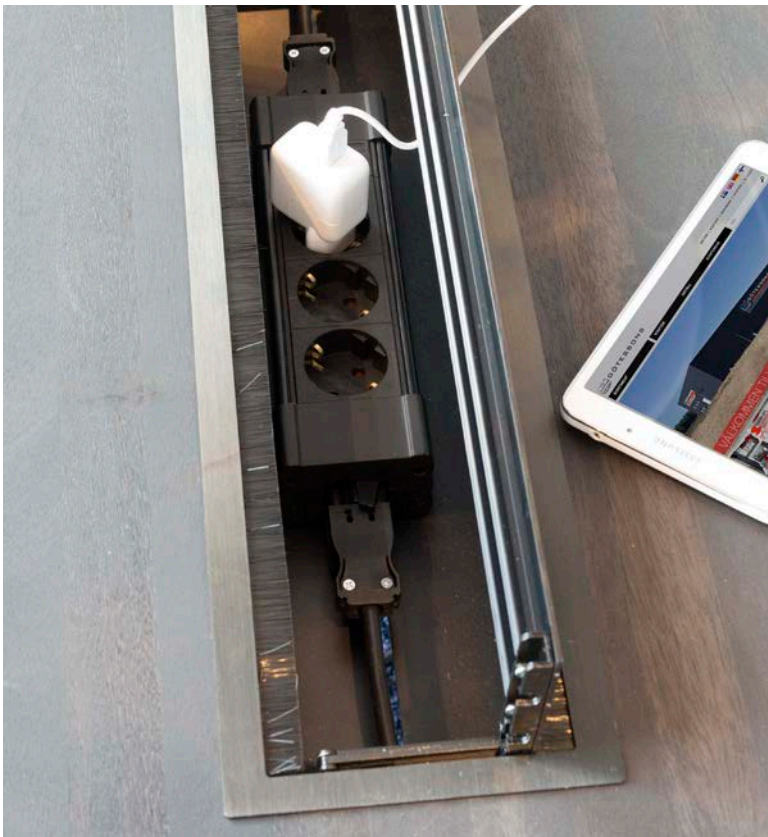

GST18 junction box with quick release connectors for a simple connection of several junction boxes. Suits ex. Bi-Boxes. Max 16 A.

## GST18

### Junction Box GST18

Junction box with GST18 connector for series connection.

721803 3 extension

black

27.98



721806 6 extension

black

35.21

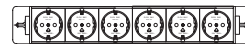

### GST18 start cable

To connect GST18 junction box with socket.

721804 L. 3 m, Schuko-GST18 male

black

27.98

721805 L. 5 m, Schuko-GST18 male

black

33.72

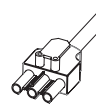

### GST18 cable extension

To connect GST18 junction box with each other.

721807 L. 1 m, GST18 female - GST18 male

black

27.98

721808 L. 3 m, GST18 female - GST18 male

black

30.64



### GST18 connection

1 male, 2 female

721810

black

12.66



## TABLE TOP SLIM

Table Top Slim are delivered with 3 m electricity cable.



### Table Top Slim 2 ext

Table cut out, 160x62 mm.

691229 silver -1 white -2 black -4 copper

90.21



### Table Top Slim 1 ext. 2 USB charge

Table cut out, 160x62 mm.

691226 silver -1 white -2 black -4 copper

110.00

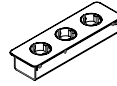

### Table Top Slim 3 ext

Table cut out, 230x62 mm

691227 silver -1 white -2 black -4 copper

105.21

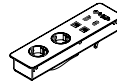

### Table Top Slim 2 ext, 2 net, USB data, VGA, HDMI, audio

Table cut out, 270x62 mm. 3 m extension cable and other cables 0,2 m included.

691228 silver -1 white -2 black -4 copper

175.74



### Table Top Slim 1 ext, 1 USB A, 1 USB C charge

Table cut out, 160x62 mm.

691230 silver -1 white -2 black -4 copper

110.85

Its discrete design and in-desk mounting allows for a clean desk space. Is available with different outlets and colours for easy desk level charging.



## TABLE TOP SLIM, WITH HOLE FOR THE LIGHTNING

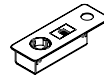

### Table Top Slim, with hole for The Lightning

Table Top Slim with a hole suitable for The Lightning. 3 m extension cable included. 1 ext, 2 USB charge.

Table cut out: 148x62 mm and drilled hole  $\varnothing$  25 mm.

821161-1 white 121.06

821161-2 black 121.06



### The Lightning Desk Lamp

Can be mounted on the desk or in a Table Top with hole for a lamp. Drilled hole  $\varnothing$  25 mm. 3,5 m cable. Has an unearthed plug.

821055-1 See drawing white 516.91

821055-2 See drawing black 516.91

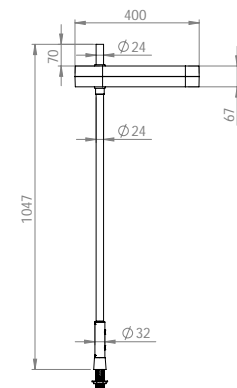



## POWER BOX SINGLE

Developed to discreetly supply desks and conference tables with power and network when they are needed for charging during work and meetings. Ideal for working with laptops and charging phones.

## POWER BOX SINGLE

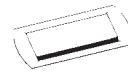

### Power Box 3 ext, 2 net\*

691000	silver	230.85
691000-1	white	254.15

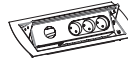

### Power Box 3 ext. hole for retractable cables

691070	silver	214.89
691070-1	white	236.38

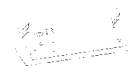

### Power Box 3 ext, net, VGA, HDMI, audio

691037	silver	336.81
691037-1	white	370.21



## POWER BOX EXTRA LONG

Power Box Extra Long offers more alternatives and comes as an openable top with or without sockets. Use to hide cables or connect them to charge. The image shows: 3 extensions, 1 network, VGA, HDMI, audio and 2 USB.

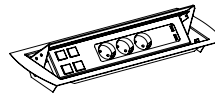

### Power box extra long

Table cut out, 367x135 mm. W. 432 H. 72

### Power Box extra long, 3 extensions, 2 USB charge\*\*

691750	silver	291.91
691750-1	white	321.06

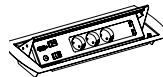

### Power Box extra long, 3 extensions, 1 network, 2 USB, VGA, HDMI, audio

691760	silver	454.04
691760-1	white	499.47

### Extra network connections

Network conn. Cat.6 for punched holes. Suits also as an extension of network cables (female-female).

700581	black	15.96
--------	-------	-------

### Extra HDMI module

For punched holes in the Power Box.

700607	black	44.47
--------	-------	-------

Power Box is always delivered with a 1,5 m power cable.

Depth when closed: see drawing on [www.gotessons.com](http://www.gotessons.com)

Hole for mounting: 286x135 mm. W. 170.



## CABLE HOLDER FOR CONFERENCE TABLES

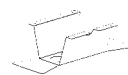

### Cable holder for Conference table

Cable holder adapted for the Power Box Single, with foldable ends for optimum suitability. Made from sheet-metal.

Width bottom: 130 mm. Top 270 mm.

720010-1	L. 290	W. 130-270	D. 141	white	56.49
720010-2	L. 290	W. 130-270	D. 141	black	56.49
720010-3	L. 290	W. 130-270	D. 141	silver	51.70



### Cable holder for Conference table

Cable holder adapted for the Power Box Single, with foldable ends for optimum suitability. Made from sheet-metal.

Width bottom: 130 mm. Top 270 mm.

720000-1	L. 660	W. 130-270	D. 141	white	81.28
720000-2	L. 660	W. 130-270	D. 141	black	81.28
720000-3	L. 660	W. 130-270	D. 141	silver	74.57

Only available in CE schuko.

\*\*Possible to add 4 extra network connections.





## POWER GROMMET TWIST

With bayonet for easier mounting. Quick and easy to install in an 80 mm diameter circular hole.

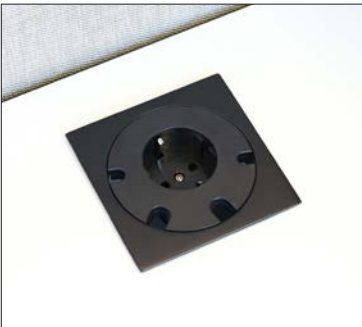

### POWER GROMMET TWIST Ø 80 MM.

1 extension, 4 cable holes  
Black/black.



### POWER GROMMET TWIST Ø 80 MM.

1 extension, 4 cable holes.  
Black/copper.



### POWER GROMMET TWIST USB RUND Ø 80 MM.

1 ext, USB C charge.  
Black/white.



### POWER GROMMET TWIST USB RUND Ø 80 MM.

1 ext, USB C charge.  
Black/black.

## POWER GROMMET

Fits in any Ø 80 mm grommet hole. With socket. 1,5 m. cable included. For Power Grommet with charging, a 1.5 m USB cable is also included.

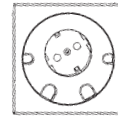

### Power Grommet Twist, Ø 80 mm

1 extension, 4 cable holes

700532 black/silver -1 black /white -2 black/black -3 black/copper 41.81

### Power Grommet Twist

1 FR extension, 4 cable holes

700539 black/silver -1 black /white -2 black/black -3 black/copper 48.09

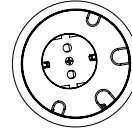

### Power Grommet Twist, round Ø 80 mm

1 extension, 4 cable holes

703532 black/silver -1 black /white -2 black/black -3 black/copper 41.81

### Power Grommet Twist FR round Ø 80 mm

1 FR extension, 4 cable holes

703539 black/silver -1 black /white -2 black/black -3 black/copper 49.57

*Fits in any Ø 80 mm grommet hole. With socket. 1,5 m. cable included.*

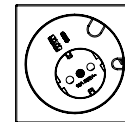

### Power Grommet Twist, Ø 80 mm

1 extension, USB A+C charge

706532 black/silver -1 black /white -2 black/black -3 black/copper 85.64

### Power Grommet Twist FR, Ø 80 mm

1 FR ext, USB A+C charge

706539 black/silver -1 black /white -2 black/black -3 black/copper 88,40

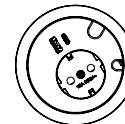

### Power Grommet Twist, round Ø 80 mm

1 extension, USB A+C charge

707532 black/silver -1 black /white -2 black/black -3 black/copper 85.64

### Power Grommet Twist FR, round Ø 80 mm

1 FR ext, USB A+C charge

707539 black/silver -1 black /white -2 black/black -3 black/copper 88,40

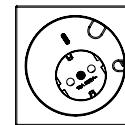

### Power Grommet Twist, Ø 80 mm

1 extension, USB C charge

708532 black/silver -1 black /white -2 black/black -3 black/copper 80.21

### Power Grommet Twist FR, Ø 80 mm

1 FR ext, USB C charge

708539 black/silver -1 black /white -2 black/black -3 black/copper 82,98

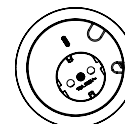

### Power Grommet Twist, round Ø 80 mm

1 extension, USB C charge

709532 black/silver -1 black /white -2 black/black -3 black/copper 80.21

### Power Grommet Twist FR, round Ø 80 mm

1 FR ext, USB C charge

709539 black/silver -1 black /white -2 black/black -3 black/copper 82,98

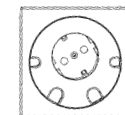

### Power Grommet GST18 Ø 80 mm

700332 1 extension, 4 cable holes black/silver 50.53



Max Power Grommet is a smooth solution for cable management and direct access to electricity and USB charging ports. Available with different outlets to suit your needs.

## MAX POWER GROMMET Ø 80 MM

### Max Power Grommet Ø 80 mm

*Fits in a Ø 80 mm hole. Cable 1,5 m.*



721500-1	1 ext, 2 USB charge	white	83.09
721500-2	1 ext, 2 USB charge	black	83.09
721500-1-FR	1 ext FR, 2 USB charge	white	83.09
721500-2-FR	1 ext FR, 2 USB charge	black	83.09



721501-1	1 ext, 1 HDMI, 2 USB charge	white	102.34
721501-2	1 ext, 1 HDMI, 2 USB charge	black	102.34
721501-1-FR	1 ext FR, 1 HDMI, 2 USB charge	white	102.34
721501-2-FR	1 ext FR, 1 HDMI, 2 USB charge	black	102.34



721502-1	1 ext, HDMI, USB A+C charge	white	107.23
721502-2	1 ext, HDMI, USB A+C charge	black	107.23
721502-1-FR	1 ext FR, HDMI, USB A+C charge	white	107.23
721502-2-FR	1 ext FR, HDMI, USB A+C charge	black	107.23

*HDMI-cable included, 1,5 m.*



721503-1	1 ext, USB A+C charge	white	96.70
721503-2	1 ext, USB A+C charge	black	96.70
721503-1-FR	1 FR extension, USB A, USB C charge	white	96.70
721503-2-FR	1 FR extension, USB A, USB C charge	black	96.70



## MINI USB GROMMET Ø 30 MM



### Mini USB Grommet Ø 30 mm

*Fits in a Ø 30 mm hole. 4 lids are included in black, white, silver and copper. Cable 1,5 m. D. 98.6*

721400	2 USB charger	54.26
721420	1 USB A, 1 USB C charge	66.60

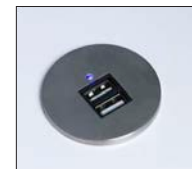

White

Silver

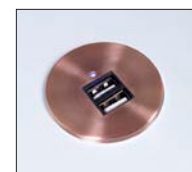

Black

Copper





## G-POWER QI WIRELESS CHARGER FOR MOBILES

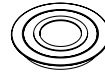

### G-Power Qi

Wireless charger for mounting in hole of Ø 80 mm. USB cable included, 1 m.  
721333 black 78.09

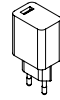

### Wall adapter USB A

Adapter for wall sockets.

704535 black 17.02

Wireless charger for mobile phones compatible with Qi standard. Charging cover for mobile phones without this feature are available on the market.



## OFFICE POWER CLAMP

Aluminum profile, can be used in various ways. Can be ordered with English and French/Polish sockets. Clamp and 2,88 m cable included.

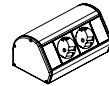

### Office Power Clamp, 2 schuko sockets

697038 W. 146 H. 78 D. 91 silver 72.87

### Office Power Clamp 2 UK sockets

697041 W. 160 H. 78 D. 91 silver 77.34

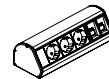

### Office Power Clamp, 3 schuko sockets, 2 net

697030 W. 230 H. 78 D. 91 silver 90.21

### Office Power Clamp 3 UK sockets, 2 net

697033 W. 253 H. 78 D. 91 silver 92.77

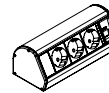

### Office Power Clamp, 3 schuko sockets, one hole for retractable cable

697048 W. 200 H. 78 D. 91 silver 90.21

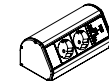

### Office Power Clamp, 2 schuko sockets, 2 USB charge

697049 W. 170 H. 78 D. 91 silver 90.21

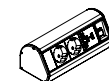

### Office Power Clamp, 2 schuko sockets, 1 net, 2 USB charge

697042 W. 200 H. 78 D. 91 silver 102.13

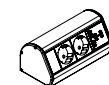

### Office Powerclamp 2 schuko sockets, USB A, USB C charge

697052 W. 170 H. 78 D. 91 silver 96.06

A user friendly anodized aluminum frame including desk clamp and a 2,88 m electrical cable.



## CABLES



### HDMI

Audio - visual digital connection between monitor and CPU. An audio-visual connection to the main monitor.

#### HDMI cable

700591	L. 2 m male-male	black	17.55
700592	L. 5 m male-male	black	31.17

#### HDMI cable

*Fabric covered cables.*

700610	L. 1,5 m	black	23.19
700611	L. 1,5 m	red	23.19



### VGA

Analogue connection between monitor and CPU.

#### Monitor cable (VGA)

700550	L. 2 m male-female cable extension	grey	24.79
700584	L. 1 m male-male	grey	21.17
700578	L. 2 m male-male	grey	26.28
700566	L. 5 m male-male	grey	32.77
700577	L. 15 m male-male	grey	82.02

#### VGA cable

*Fabric covered cables.*

700612	L. 1,5 m	black	21.38
700613	L. 1,5 m	red	21.38



### Displayport

Audio - visual digital connection between monitor and CPU. Commonly used on Mac.

#### Displayport

700614	L. 3 m male-male	black	29.26
--------	------------------	-------	-------



### Network Cat. 6

Internet access.

#### Network cable STP Cat.6 Shielded

700575	L. 1m	grey	9.68
700621	L. 3 m	grey	12.87
700559	L. 5 m	grey	12.87
700571	L. 7 m	grey	17.87
700568	L. 10 m	grey	22.77



### Mini-jack 3,5 mm

Analogue audio connection. For adding audio to presentations or for headset use.

#### Audio cable (for mini-jack) 3,5 mm

700572	L. 5 m male-female cable extension	black	14.79
700595	L. 2 m male-male	black	12.34
700596	L. 5 m male-male	black	17.55



### GST18

Splits one incoming network connection into 5 or 16 useable connections.

#### GST18 start cable

To connect GST18 junction box with socket.

721804	L. 3 m, Schucko-GST18 male	black	27.98
721805	L. 5 m, Schucko-GST18 male	black	33.72

#### GST18 cable extension

To connect GST18 junction box with each other.

721807	L. 1 m, GST18 female-GST18 male	black	27.98
721808	L. 3 m, GST18 female-GST18 male	black	30.64



#### GST18 connection

721810	1 male, 2 female	black	12.66
--------	------------------	-------	-------



### USB

To transfer data or charge. Connect memory sticks for office presentations, camera memory card readers, GPS or printers.



### USB C

To transfer data or charge. Connect memory sticks for office presentations, camera memory card readers, GPS or printers.



### VGA switch

To connect several CPU:s to one projector or main monitor. Switch from one CPU to another via remote control.

#### Video-switch (VGA)

Plug in up to 8 computers to one monitor/LCD/projector. Switch with remote control. Max resolution 2048x1536. Place in conference cable holder. CE schuko.

700588	W. 200 H. 40	black	319.04
--------	--------------	-------	--------



### Network switch

Splits one incoming network connection into 5 or 16 useable connections.

#### Network switch (CE schuko)

16 ports, 10/100 Mbps. Exterior dimension: 200x40x142 mm. Can be placed in a cable holder for conference table.

700587		black	127.23
--------	--	-------	--------

#### Network switch (CE schuko)

5 ports, 10/100 Mbps. Exterior dimension: 148x28x87 mm. Can be placed in a cable holder for conference table.

700580		white	69.15
--------	--	-------	-------

#### Plastic clip for cables: VGA, network, audio etc.

700567		white	3.19
--------	--	-------	------

**Compromise elsewhere.**





## BY DAVID DESIGN

We embrace individuality and refuse to follow the norm. We challenge the status quo. We strive for something beyond the ordinary. We create so that you can express your own style, attitude, and unique personality. With David design, you can stand out from the crowd, add the finishing touch, own something for generations, and showcase your personal style. Every detail has a purpose, and every part serves a function. We've refused to compromise for 30 years and have no intention of starting now. That's our promise.

Categories	Page
CHAIRS & ARMCHAIRS	142
TABLES	154
LIGHTING	155
SOFAS	156
TEXTILES	269



Design: Constance Guisset

## O CHAIR

O chair is an invitation to let metal thread expresses itself. The base of the Chair act like a weaving loom, constraining the wires and revealing their Flexibility. Comfortable and stackable, available in a wide range of colors. The chair can be used inside and outside. A special cushion can be added for even greater coziness.



### Tecnical information

Height	805 mm
Depth	537 mm
Width	511 mm
Seat height	450 mm
Seat depth	400 mm
Seat width	398 mm
Weight	6,5 kg
Volume	0,22 m3

### Price cushion

A	84,00
B	96,00
C	108,00
D	133,00
E	157,00
F	169,00
Leather 1	157,00
Leather 2	181,00

O Chair

359



RAL 3012  
Biege red



RAL 7031  
Blue grey



RAL 9001  
Cream



RAL 6007  
Bottle green



RAL 3005  
Wine red





Design: Bonpart

## NOMIA

An armchair with slightly pompous shapes pressed against a steel frame. The chair and seat are separate parts, allowing for different fabric choices.



### Technical information

Height	820 mm
Depth	600 mm
Width	650 mm
Seat height	450 mm
Seat depth	470 mm
Seat width	430 mm
Weight	9,5 kg
Volume	0,32 m3
Fabric	1,2 m

GDG textile/Upholstery com	955,00
A	1006,00
B	1056,00
C	1095,00
D	1184,00
E	1260,00
F	1311,00
Leather 1	1438,00
Leather 2	1693,00

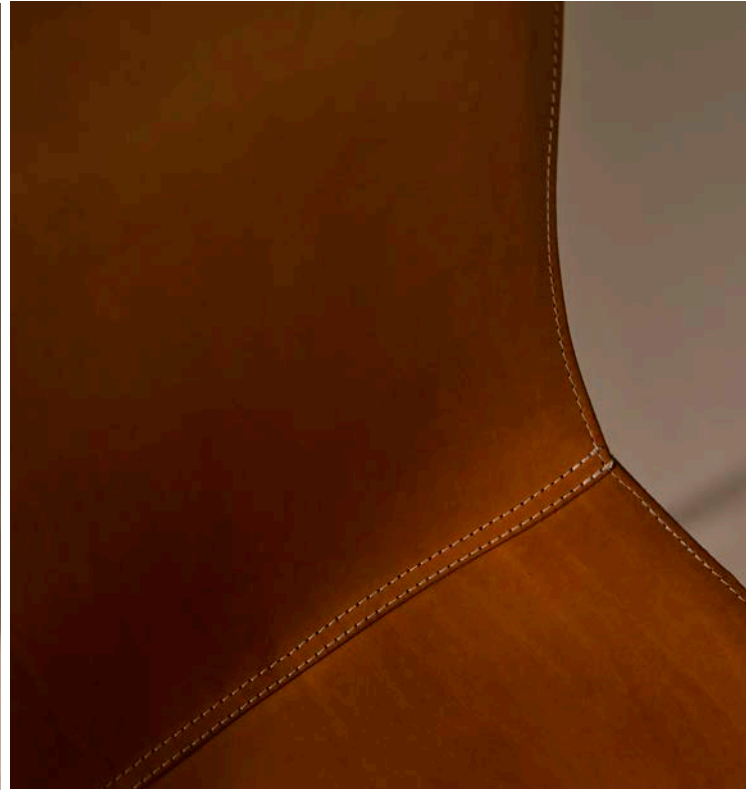

Design: Axel Bjurström

## HAMMOCK CHAIR

Chair in vegetable-tanned leather with a black steel frame.



## HAMMOCK CHAIR

### Technical information

Height	820 mm
Depth	600 mm
Width	650 mm
Seat height	450 mm
Seat depth	470 mm
Seat width	430 mm
Weight	9,5 kg
Volume	0,32 m <sup>3</sup>
Fabric	1,2 m

### Base in black:

Black Leather	621,00
Brown Leather	621,00
Cognac Leather	621,00
Nature Leather	621,00



## HAMMOCK LOUNGE

### Technical information

Height	750 mm
Depth	750 mm
Width	570 mm
Seat height	400 mm
Weight	8 kg
Volume	0,4 m <sup>3</sup>

### Base in black:

Black Leather	1023,00
Brown Leather	1023,00
Cognac Leather	1023,00
Nature Leather	1023,00



## HAMMOCK BENCH

### Technical information

Height	450 mm
Depth	450 mm
Length	1820 mm
Seat height	450 mm
Weight	7 kg
Volume	0,48 m3

### Base in black:

Black Leather	1800,00
Brown Leather	1800,00
Cognac Leather	1800,00
Nature Leather	1800,00



## HAMMOCK POUF

### Technical information

Height	420 mm
Depth	420 mm
Width	550 mm
Seat height	410 mm
Weight	5 kg
Volume	0,2 m3

### Base in black:

Black Leather	550,00
Brown Leather	550,00
Cognac Leather	550,00
Nature Leather	550,00



## HAMMOCK BAR

### Technical information

Height	855 or 955 mm
Depth	485 mm
Width	445 mm
Seat height	650 or 750 mm
Weight	8 kg
Volume	0,4 m3

### Base in black:

Black Leather	740,00
Brown Leather	740,00
Cognac Leather	740,00
Nature Leather	740,00



## HAMMOCK STOOL

### Technical information

Height	650 or 750 mm
Depth	355 mm
Width	450 mm
Seat height	650 or 750 mm
Weight	7 kg
Volume	0,3 m3

### Base in black:

Black Leather	
Brown Leather	699,00
Cognac Leather	699,00
Nature Leather	699,00



Design: Daniel Enoksson

## LEAN

Lean is made of molded wood and can be upholstered in any fabric or leather of your choice.



### LEAN

#### Technical information

Height	805 mm
Depth	537 mm
Width	511 mm
Seat height	450 mm
Seat depth	400 mm
Seat width	398 mm
Weight	6,5 kg
Volume	0,22 m <sup>3</sup>

#### Base in black:

GDG textile/Upholstery com	365,00
A	386,00
B	402,00
C	423,00
D	456,00
E	467,00
F	528,00
Leather 1	586,00



### LEAN ARMCHAIR

#### Technical information

Height	805 mm
Depth	537 mm
Width	511 mm
Seat height	450 mm
Seat depth	400 mm
Seat width	398 mm
Weight	6,5 kg
Volume	0,22 m <sup>3</sup>

#### Base in black:

GDG textile/Upholstery com	469,00
A	483,00
B	498,00
C	519,00
D	551,00
E	580,00
F	621,00
Leather 1	674,00



## LEAN 4

### Technical information

Height	780 mm
Depth	570 mm
Width	520 mm
Seat height	450 mm
Seat depth	430 mm
Seat width	415 mm
Weight	6 kg
Volume	0,27m <sup>3</sup> /4
Fabric	0,6m

### Base in black:

GDG textile/Upholstery com	384,00
A	400,00
B	419,00
C	440,00
D	463,00
E	484,00
F	530,00
Leather 1	597,00
Leather 2	710,00



## LEAN 4 ARMCHAIR

### Technical information

Height	780 mm
Depth	520 mm
Width	550 mm
Seat height	450 mm
Seat depth	430 mm
Seat width	415 mm
Weight	9 kg
Volume	0,31 m <sup>3</sup> /4
Fabric	0,6 m

### Base in black:

GDG textile/Upholstery com	538,00
A	578,00
B	597,00
C	616,00
D	639,00
E	662,00
F	706,00
Leather 1	773,00
Leather 2	886,00



## LEAN 4 BAR

### Technical information

Tyg	0,5 m/2 st.
Height	880/980/1050 mm
Depth	470 mm
Width	410 mm
Seat height	650/750/820 mm
Weight	10 kg
Volume	0,42 m <sup>3</sup>

### Base in black:

GDG textile/Upholstery com	515,00
A	528,00
B	547,00
C	564,00
D	582,00
E	601,00
F	639,00
Leather 1	684,00
Leather 2	773,00



## LEAN STOOL

### Technical information

Tyg	0,5 m/2 st.
Height	650/750/820
Seat depth	450 mm
Width	400 mm
Seat height	650/750/820
Weight	8 kg
Volume	0,33

### Base in black:

GDG textile/Upholstery com	405,00
A	416,00
B	426,00
C	441,00
D	455,00
E	471,00
F	499,00
Leather 1	551,00
Leather 2	619,00



Design: Superlab

## PORTIA

The Portia armchair is made of molded wood and can be upholstered in any fabric or leather of your choice.



## PORTIA

### Technical information

Height	790 mm	GDG textile/Upholstery com	565,00
Width	550 mm	A	681,00
Seat height	450 mm	B	732,00
Seat depth	435 mm	C	796,00
Height armrest	640 mm	D	896,00
Tyg	1,5 m	E	989,00
Weight	8 kg	F	1114,00
Volume	0,35 m <sup>3</sup>	Leather 1	1170,00
Stapelbar	6 st		

### Base in black:



## PORTIA WHEEL

### Technical information

Height	790 mm	GDG textile/Upholstery com	702,00
Width	550 mm	A	804,00
Seat height	450 mm	B	856,00
Seat depth	435 mm	C	912,00
Height armrest	640 mm	D	973,00
Tyg	1,5 m	E	1035,00
Weight	8 kg	F	1157,00
Volume	0,35 m <sup>3</sup>	Leather 1	1251,00
Stapelbar	6 st	Leather 2	1538,00

### Base in black:



## PORTIA LOUNGE

### Technical information

Height	800 mm	GDG textile/Upholstery com	1824,00
Depth	800 mm	A	1939,00
Width	750 mm	B	2052,00
Seat height	420 mm	C	2169,00
Weight	15 kg	D	2300,00
Tyg	3,2 m	E	2430,00
Volume	0,61 m <sup>3</sup>	F	2685,00
		Leather 1	2370,00
		Leather 2	2673,00

### Base in black:



Design: Lars Hofsjö

## SKIFT MEDAR

A compact armchair design. The seat and backrest are separate, offering the freedom to choose materials. The gap between the seat and backrest provides an open design and facilitates easy cleaning. All upholstered components feature a core of eco-friendly molded wood, ensuring long durability. The armrests are high enough for maximum comfort yet low enough to slide the chair under most tabletops.



## SKIFT MEDAR

### Technical information

Height	790 mm
Depth	550 mm
Width	550 mm
Seat height	450 mm
Height armrest	690 mm
Fabric	1,25 m
Weight	8 kg
Volume	0,32 m <sup>3</sup>

### Base in black:

GDG textile/Upholstery com	540,00
A	609,00
B	646,00
C	694,00
D	768,00
E	837,00
F	934,00
Leather 1	978,00



## SKIFT PLUS MEDAR

### Technical information

Height	790 mm
Depth	585 mm
Width	580 mm
Seat height	450 mm
Height armrest	690 mm
Fabric	1,6 m

### Base in black:

GDG textile/Upholstery com	628,00
A	695,00
B	744,00
C	809,00
D	909,00
E	1001,00
F	1129,00
Leather 1	1059,00





SKIFT 4 WHEEL

**Technical information**

Height	790 mm	GDG textile/Upholstery com	877,00
Depth	550 mm	A	923,00
Width	550 mm	B	961,00
Seat height	450 mm	C	1008,00
Height armrest	690 mm	D	1084,00
Fabric	1,25 m	E	1153,00
		F	1250,00
		Leather 1	1198,00

**Base in black:**



SKIFT 5 WHEEL

**Technical information**

Height	790 mm	GDG textile/Upholstery com	1048,00
Depth	550 mm	A	1096,00
Width	550 mm	B	1136,00
Seat height	450 mm	C	1186,00
Height armrest	690 mm	D	1267,00
Fabric	1,25 m	E	1337,00
		F	1437,00
		Leather 1	1382,00

**Base in black:**



SKIFT PLUS 4 WHEEL

**Technical information**

Height	790 mm	GDG textile/Upholstery com	952,00
Depth	585 mm	A	1015,00
Width	580 mm	B	1063,00
Seat height	450 mm	C	1129,00
Height armrest	690 mm	D	1228,00
Fabric	1,6 m	E	1321,00
		F	1451,00
		Leather 1	1377,00

**Base in black:**



SKIFT PLUS 5 WHEEL

**Technical information**

Height	790 mm	GDG textile/Upholstery com	1089,00
Depth	585 mm	A	1153,00
Width	580 mm	B	1202,00
Seat height	450 mm	C	1268,00
Height armrest	690 mm	D	1367,00
Fabric	1,6 m	E	1459,00
		F	1589,00
		Leather 1	1514,00

**Base in black:**



## SKIFT PLUS 4

### Technical information

Height	790 mm
Depth	585 mm
Width	580 mm
Seat height	450 mm
Height armrest	690 mm
Fabric	1,6 m

GDG textile/Upholstery com	698,00
A	766,00
B	815,00
C	879,00
D	980,00
E	1072,00
F	1202,00
Leather 1	1129,00

### Base in black:



## SKIFT PLUS WOOD

### Technical information

Height	790 mm
Depth	585 mm
Width	580 mm
Seat height	450 mm
Height armrest	690 mm
Fabric	1,6 m

GDG textile/Upholstery com	923,00
A	974,00
B	1022,00
C	1084,00
D	1181,00
E	1267,00
F	1392,00
Leather 1	1323,00



## SKIFT BAR

### Technical information

Height	1000 mm
Depth	550 mm
Width	550 mm
Seat height	650 mm
Height armrest	900 mm
Fabric	1,4 m
Weight	9 kg
Volume	0,4 m3

GDG textile/Upholstery com	688
A	757,00
B	793,00
C	842,00
D	917,00
E	987,00
F	1084,00
Leather 1	1131,00
Leather 2	1279,00

### Base in black:



TOAD

Design: Ruud Ekstrand and Christer Norman

The armchair features a supporting fabric suspended on a metal frame. The thick cushion with deep stitching provides excellent seating comfort. The frame is made of 25 mm steel tubing. In the late 1960s, Ruud Ekstrand and Christer Norman designed this iconic lounge chair.



,00

Technical information

Height	840 mm
Seat depth	1040 mm
Width	900 mm
Weight	15 kg
Volume	0,6 m <sup>3</sup>
Fabric	2,8 m

GDG textile/Upholstery com	1558,00
A	1689,00
B	1768,00
C	1883,00
D	2054,00
E	2213,00
F	2435,00
Leather 1	2597,00
Sheep skin	3334,00



Connecting bracket for linking multiple Toad chairs.

94,00



Design: Daniel Enoksson

## TO GO

A laptop table or desk designed to pair with sofas, chairs, and armchairs. The distinctive handle serves both as a functional element for moving the table and as a weight for adjusting the table height. Height-adjustable table with a tabletop in wood or laminate and a metal base.



## TO GO

### Technical information

15"

Height	490–795 mm	black stained ash	504,00
Length	440 mm		
Depth	280 mm		
Weight	4 kg		
Volume	0,2 m3		



## TO GO XL

Pneumatically height-adjustable without any cables or need for electrical connection. The shape of the tabletop makes it suitable as a side table and a workstation.

### Technical information

Height	740–1140 mm	black mdf	1128,00
Length	1053 mm	white laminate	1128,00
Depth	652 mm	black stained ash veneer	1260,00
Weight	28 kg	white pigmented ash laminate	1260,00
Volume	0,5 m3		



Design: Lars Hofsjö

## OPI

A collection of smaller tables with a characteristic look achieved through the simplicity of their design, featuring an asymmetrical base.



### OPI HEIGHT 500

#### Technical information

Height	500 mm	black lacquered metal	441,00
Diameter	450 mm		



### OPI HEIGHT 720

#### Technical information

Height	720 mm	black lacquered metal	594,00
Diameter	700 mm		



Design: Claesson Koivisto Rune

## HEPBURN PENDANT LAMP

A pendant lamp, a sound absorber, and a piece of art. Available in three sizes with soft shapes made of molded felt. Its design makes it ideal for hanging in clusters as well as a standalone piece. Includes dimmable LED 4.5W, 300LM, 2700K. Plug not included.



### HEPBURN BUCKET

Light grey	305,00
Dark grey	305,00
Green	305,00

#### Technical information

Height	145 mm
Diameter	195 mm

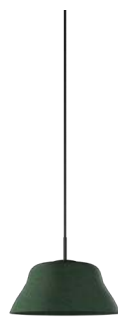

### HEPBURN DERBY

Light grey	420,00
Dark grey	420,00
Green	420,00

#### Technical information

Height	180 mm
Diameter	380 mm



### HEPBURN BRIM

Light grey	611,00
Dark grey	611,00
Green	611,00

#### Technical information

Height	245 mm
Diameter	605 mm



**Design:** Claesson Koivisto Rune

## COLLAGE SOFA

Collage 2.0 is an exclusive sofa collection featuring a piping detail running along the seat and back cushions. The slim armrests maximize seating space, complemented by long, continuous back cushions. The series includes armchairs, sofas, and modular sofas, customizable with legs in wood or metal and a wide selection of fabrics or leather.

### COLLAGE 2.0 1-SEAT LOW



#### Technical information

Height	625 mm
Depth	835 mm
Length	840 mm
Seat height	400 mm
Seat depth	650 mm
Fabric	4,5 m
Weight	26 kg
Volume	0,6 m3

GDG textile/Upholstery com	1974,00
A	2094,00
B	2205,00
C	2354,00
D	2584,00
E	2794,00
Leather	3371,00

Steel legs in black  
Wooden legs in oak

### COLLAGE 2.0 1,5-SEAT LOW



#### Technical information

Height	625 mm
Depth	835 mm
Length	1150 mm
Seat height	400 mm
Fabric	6,0 m
Weight	38 kg
Volume	0,75 m3

GDG textile/Upholstery com	2135,00
A	2339,00
B	2413,00
C	2757,00
D	2990,00
E	3225,00
Leather	4022,00

Steel legs in black  
Wooden legs in oak

## COLLAGE 2.0 2 SEAT LOW



### Technical information

Height	625 mm
Depth	835 mm
Length	1600 mm
Seat height	400 mm
Seat depth	650 mm
Fabric	7,5 m
Weight	40 kg
Volume	1,1 m3

GDG textile/Upholstery com	3089,00
A	3483,00
B	3697,00
C	3998,00
D	4445,00
E	4862,00
Leather 1	5780,00

Steel legs in black  
Wooden legs in oak

## COLLAGE 2.0 3-SEAT LOW



### Technical information

Height	625 mm
Depth	835 mm
Length	2220 mm
Seat height	400 mm
Seat depth	650 mm
Fabric	10,2 m
Weight	60 kg
Volume	1,52 m3

GDG textile/Upholstery com	3551,00
A	4111,00
B	4390,00
C	4800,00
D	5402,00
E	5960,00
Leather 1	6505,00

Steel legs in black  
Wooden legs in oak



MAKE A RIGH CHOICE.  
CHOOSE A SOFA FROM THE COLLAGE SERIES.





Design: Lars Hofsjö

## ONE LOUNGE MODULE SYSTEM

A modular sofa system designed for seating from all four sides, thanks to its flat seat. Options include a base or legs in two different heights for a seat height of 400 mm or 450 mm. The seat depth and lounge backrest can be connected to the seat. Modules and shelves are available in various sizes and shapes.

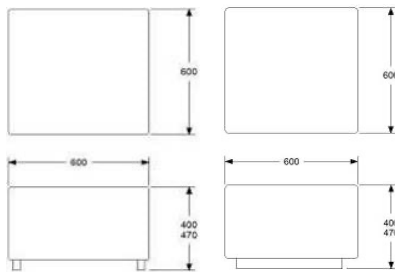

### ONE SEAT 600

Height 400 mm  
 Depth 600 mm  
 Width 600 mm  
 Fabric 1,3 m  
 Weight 15 kg  
 Volume 0,20 m<sup>3</sup>

	with legs	with socket
GDG textile/Upholstery com	484,00	3900,00
A	580,00	5034,00
B	618,00	5381,00
C	675,00	5830,00
D	755,00	6525,00
E	827,00	7164,00
F	935,00	8061,00
Leather 1	989,00	8419,00
Addition: 120 mm for a seat height of 450 mm	20,00	72,00

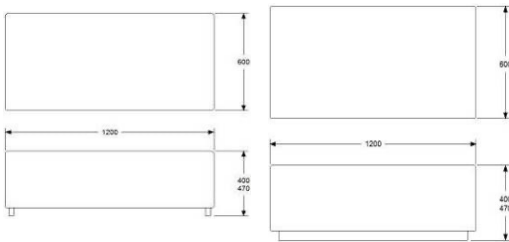

### ONE SEAT 1200

Height 400 mm  
 Depth 600 mm  
 Width 1200 mm  
 Fabric 1,9 m  
 Weight 28 kg  
 Volume 0,40 m<sup>3</sup>

	with legs	with socket
GDG textile/Upholstery com	935	888
A	1075	1025
B	1131	1078
C	1211	1155
D	1328	1268
E	1440	1374
F	1594	1523
Leather 1	1655	1581
Addition: 120 mm for a seat height of 450 mm	20	90

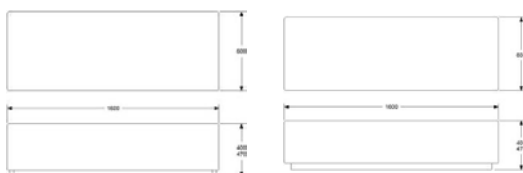

### ONE SEAT 1600

Height 400 mm  
 Depth 600 mm  
 Width 1600 mm  
 Fabric 2,3 m  
 Weight 35 kg  
 Volume 0,50 m<sup>3</sup>

	with legs	with socket
GDG textile/Upholstery com	1146	1093
A	1317	1257
B	1386	1323
C	1483	1416
D	1626	1553
E	1759	1681
F	1945	1860
Leather 1	2006	1919
Addition: 120 mm for a seat height of 450 mm	20	106

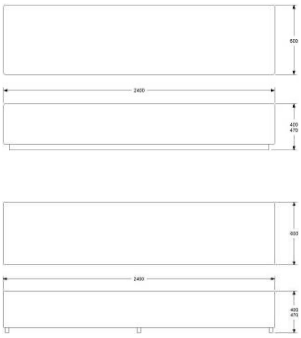

## ONE SEAT 2400

Height 400 mm  
 Depth 600 mm  
 Width 2400 mm  
 Fabric 3,1 m  
 Weight 52 kg  
 Volume 0,73 m<sup>3</sup>

	with legs	with socket
GDG textile/Upholstery com	1593,00	1530,00
A	1819,00	1749,00
B	1912,00	1841,00
C	2040,00	1964,00
D	2235,00	2151,00
E	2415,00	2323,00
F	2665,00	2550,00
Leather 1	2764,00	2663,00
Addition: 120 mm for a seat height of 450 mm	26,00	122,00

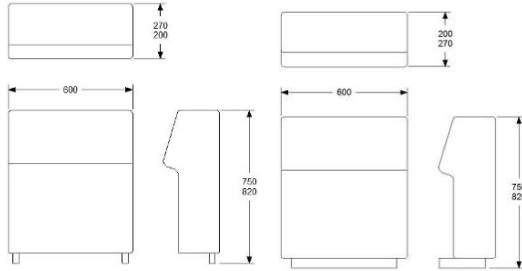

## ONE LOUNGE BACK 600

Height 750/820 mm  
 Depth 200/270 mm  
 Width 600 mm  
 Fabric 1,3 m  
 Weight 22 kg  
 Volume 0,18 m<sup>3</sup>

	with legs	with socket
GDG textile/Upholstery com	402,00	445,00
A	491,00	540,00
B	530,00	578,00
C	580,00	628,00
D	658,00	708,00
E	730,00	782,00
F	832,00	882,00
Leather 1	876,00	926,00
Addition: 120 mm for a seat height of 450 mm, total 820 mm	19,00	57,00

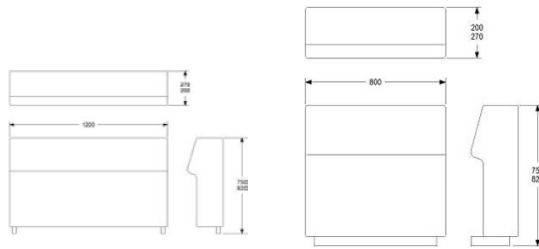

## ONE LOUNGE BACK 1200

Height 750/820 mm  
 Depth 200/270 mm  
 Width 1200 mm  
 Fabric 2,5 m  
 Weight 37 kg  
 Volume 0,25 m<sup>3</sup>

	with legs	with socket
GDG textile/Upholstery com	5429,00	661,00
A	6885,00	839,00
B	7457,00	908,00
C	8289,00	1010,00
D	9506,00	1158,00
E	10650,00	1297,00
F	12230,00	1490,00
Leather 1	12730,00	1551,00
Addition: 120 mm for a seat height of 450 mm, total 820 mm	19,00	80,00

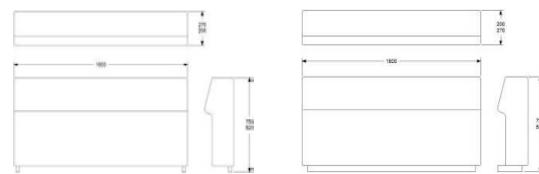

## ONE LOUNGE BACK 1600

Height 750/820 mm  
 Depth 200/270 mm  
 Width 1600 mm  
 Fabric 3,3 m  
 Weight 47 kg  
 Volume 0,30 m<sup>3</sup>

	with legs	with socket
GDG textile/Upholstery com	6354,00	6968,00
A	8237,00	8913,00
B	9038,00	9693,00
C	10109,00	10774,00
D	11721,00	12407,00
E	13229,00	13926,00
F	15330,00	16026,00
Leather 1	15839,00	16619,00
Addition: 120 mm for a seat height of 450 mm, total 820 mm	19,00	99,00

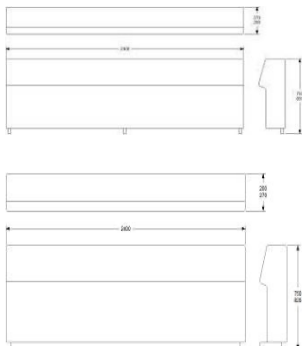

## ONE LOUNGE BACK 2400

Height 750/820 mm  
 Depth 200/270 mm  
 Width 2400 mm  
 Fabric 4,9 m  
 Weight 62 kg  
 Volume 0,74 m<sup>3</sup>

	with legs	with socket
GDG textile/Upholstery com	8840,00	9318,00
A	11658,00	12199,00
B	12802,00	13364,00
C	14414,00	14966,00
D	16817,00	17389,00
E	19053,00	19625,00
F	22183,00	22766,00
Leather 1	22381,00	23098,00
Addition: 120 mm for a seat height of 450 mm, total 820 mm	208,00	111,00

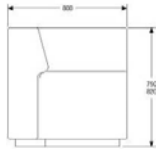
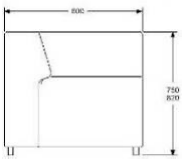
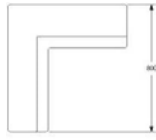
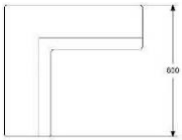

# ONE LOUNGE BACK INNER CORNER

Height 750/820 mm  
 Depth 800 mm  
 Width 800 mm  
 Fabric 2,8 m  
 Weight 36 kg  
 Volume 0,61 m<sup>3</sup>

GDG textile/Upholstery com  
 A  
 B  
 C  
 D  
 E  
 F  
 Leather 1  
 Addition: 120 mm for a seat height of 450 mm

with legs

with socket

	873,00	905,00
A	1068,00	1106,00
B	1146,00	1186,00
C	1259,00	1298,00
D	1425,00	1468,00
E	1580,00	1622,00
F	1799,00	1839,00
Leather 1	1945,00	2031,00
	25,00	87,00



Design: Lars Hofsjö

## ONE CAFÉ MODULE SYSTEM

A modular sofa system designed for seating from all four sides, thanks to its flat seat. Options include a base or legs in two different heights for a seat height of 400 mm or 450 mm. The Café system features a thinner backrest, making it ideal for placing modules back-to-back. The backrests are mounted directly onto the seat and therefore do not require their own legs or base. Walls for a more private seating area are available as an option.

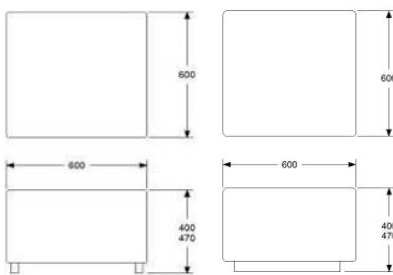

### ONE SEAT 600

Height 400 mm  
 Depth 600 mm  
 Width 600 mm  
 Fabric 1,3 m  
 Weight 15 kg  
 Volume 0,20 m<sup>3</sup>

	with legs	with socket
GDG textile/Upholstery com	484,00	475,00
A	580,00	613,00
B	618,00	655,00
C	675,00	710,00
D	755,00	795,00
E	827,00	873,00
F	935,00	982,00
Leather 1	989,00	1026,00
Addition: for Seat height of 450 mm	20,00	72,00

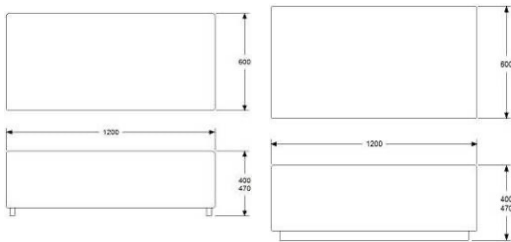

### ONE SEAT 1200

Height 400 mm  
 Depth 600 mm  
 Width 1200 mm  
 Fabric 1,9 m  
 Weight 28 kg  
 Volume 0,40 m<sup>3</sup>

	with legs	with socket
GDG textile/Upholstery com	935,00	888,00
A	1075,00	1025,00
B	1131,00	1078,00
C	1211,00	1155,00
D	1328,00	1268,00
E	1440,00	1374,00
F	1594,00	1523,00
Leather 1	1655,00	1581,00
Addition: for Seat height of 450 mm	20,00	90,00

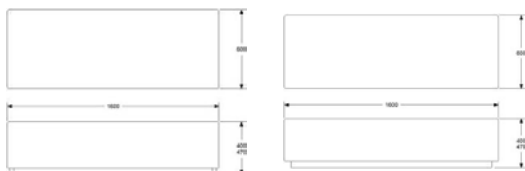

### ONE SEAT 1600

Height 400 mm  
 Depth 600 mm  
 Width 1600 mm  
 Fabric 2,3 m  
 Weight 35 kg  
 Volume 0,50 m<sup>3</sup>

	with legs	with socket
GDG textile/Upholstery com	1146,00	1093,00
A	1317,00	1257,00
B	1386,00	1323,00
C	1483,00	1416,00
D	1626,00	1553,00
E	1759,00	1681,00
F	1945,00	1860,00
Leather 1	2006,00	1919,00
Addition: for Seat height of 450 mm	20,00	106,00

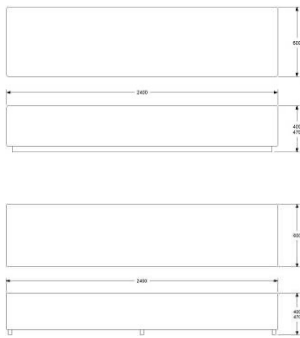

## ONE SEAT 2400

Height	400 mm
Depth	600 mm
Width	2400 mm
Fabric	3,1 m
Weight	52 kg
Volume	0,73 m3

GDG textile/Upholstery com	1593,00	with legs	1530,00
A	1819,00		1749,00
B	1912,00		1841,00
C	2040,00		1964,00
D	2235,00		2151,00
E	2415,00		2323,00
F	2665,00		2550,00
Leather 1	2764,00		2663,00
Addition: for Seat height 450 mm	26,00		122

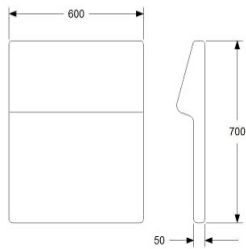

## ONE CAFÉ BACK 600

Height	750/820 mm
Depth	50/130 mm
Width	600 mm
Fabric	0,8 m
Weight	19 kg
Volume	0,16 m3

GDG textile/Upholstery com	402,00
A	457,00
B	478,00
C	510,00
D	559,00
E	603,00
F	664,00
Leather 1	745,00
Addition: gap 20 mm between seat and backrest	11,00



## ONE CAFÉ BACK 1200

Height	750/820 mm
Depth	50/130 mm
Width	1200 mm
Fabric	1,4 m
Weight	27 kg
Volume	0,22 m3

GDG textile/Upholstery com	499,00
A	598,00
B	636,00
C	694,00
D	779,00
E	856,00
F	965,00
Leather 1	1011,00
Addition: gap 20 mm between seat and backrest	15,00

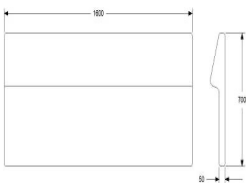

## ONE CAFÉ BACK 1600

Height	750/820 mm
Depth	50/130 mm
Width	1600 mm
Fabric	1,8 m
Weight	30 kg
Volume	0,18 m3

GDG textile/Upholstery com	645,00
A	768,00
B	818,00
C	891,00
D	1000,00
E	1101,00
F	1239,00
Leather 1	1292,00
Addition: gap 20 mm between seat and backrest	15,00



## ONE CAFÉ BACK 2400

Height	750/820 mm
Depth	50/130 mm
Width	2400 mm
Fabric	2,7 m
Weight	37 kg
Volume	0,7 m3

GDG textile/Upholstery com	891,00
A	1077,00
B	1157,00
C	1263,00
D	1425,00
E	1575,00
F	1786,00
Leather 1	1848,00
Addition: gap 20 mm between seat and backrest	18,00

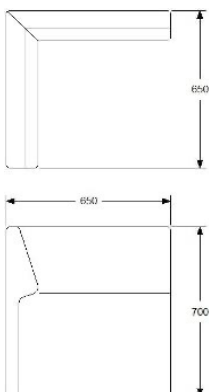

## ONE CAFÉ BACK INNER CORNER

Height	750/820 mm
Depth	650 mm
Width	650 mm
Fabric	1,6 m
Weight	28 kg
Volume	0,55 m3

GDG textile/Upholstery com	707,00
A	815,00
B	860,00
C	926,00
D	1022,00
E	1110,00
F	1234,00
Leather 1	1453,00
Addition: gap 20 mm between seat and backrest	46,00

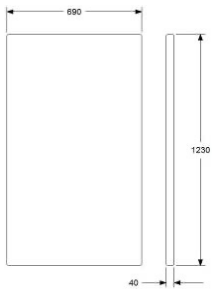

### ONE WALL SIDE 690

Height 1230 mm (1280/1350 mounted on sofa)  
 Depth 40 mm  
 Width 690 mm

Fabric 1,4 m, no pattern matching  
 Weight 15 kg  
 Volume 0,05 m<sup>3</sup>

GDG textile/Upholstery com	437,00
A	495,00
B	536,00
C	593,00
D	679,00
E	759,00
F	872,00

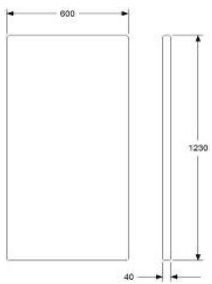

### ONE WALL SIDE 600

Height 1230 mm (1280/1350 mounted on sofa)  
 Depth 40 mm  
 Width 600 mm

Fabric 1,4 m, no pattern matching  
 Weight 15 kg  
 Volume 0,05 m<sup>3</sup>

GDG textile/Upholstery com	437,00
A	495,00
B	536,00
C	593,00
D	679,00
E	759,00
F	872,00

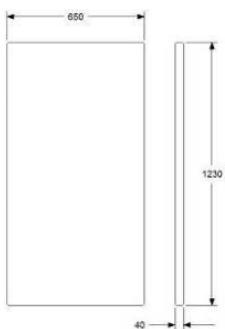

### ONE WALL SIDE 650 FOR CORNER

Height 1230 mm (1280/1350 mounted on sofa)  
 Depth 40 mm  
 Width 650 mm

Fabric 1,4 m, no pattern matching  
 Weight 15 kg  
 Volume 0,05 m<sup>3</sup>

GDG textile/Upholstery com	437,00
A	495,00
B	536,00
C	593,00
D	679,00
E	759,00
F	872,00

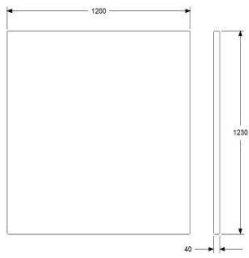

## ONE WALL 1200

Height	1230 mm (1280/1350 mounted on sofa)
Depth	40 mm
Width	1200 mm
Fabric	2,6 m, no pattern matching
Weight	35 kg
Volume	0,14 m <sup>3</sup>

GDG textile/Upholstery com	541,00
A	677,00
B	754,00
C	859,00
D	992,00
E	1134,00
F	1374,00

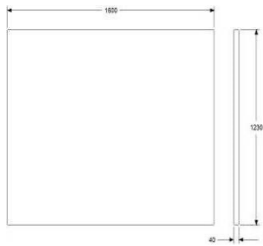

## ONE WALL 1600

Height	1230 mm (1280/1350 mounted on sofa)
Depth	40 mm
Width	1600 mm
Fabric	3,4 m, no pattern matching
Weight	40 kg
Volume	0,14 m <sup>3</sup>

GDG textile/Upholstery com	593,00
A	782,00
B	882,00
C	1020,00
D	1229,00
E	1424,00
F	1694,00



## LEGS FOR A WALL, PLACED OUTSIDE SOFA

Black lacquered

Height	120 mm
--------	--------

87,00





Design: Lars Hofsjö



## ONE AIR MODULE SYSTEM

Modular sofa system with the possibility to sit from all four sides and a guarantee for longevity. With access to a range of different elements, you can put together exactly the sofa you want and place the BACK support and walls in the direction you want. One Air has ten centimeters higher legs than One Café and Lounge, to create a neater expression and facilitate cleaning.

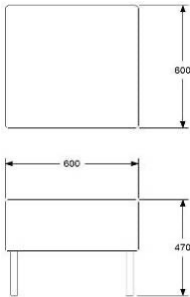

### ONE AIR SEAT 600

Height 450 mm  
 Depth 600 mm  
 Width 600 mm  
 Fabric 1,3 m  
 Weight 14 kg  
 Volume 0,20 m<sup>3</sup>

GDG textile/Upholstery com	477,00
A	569,00
B	609,00
C	664,00
D	743,00
E	815,00
F	921,00
Leather 1	974,00
Additional: removable fabric covers	85,00

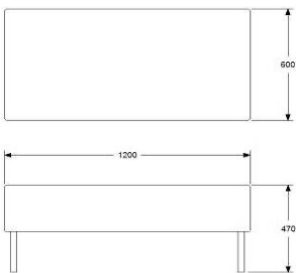

### ONE AIR SEAT 1200

Height 450 mm  
 Depth 600 mm  
 Width 1200 mm  
 Fabric 1,9 m  
 Weight 27 kg  
 Volume 0,40 m<sup>3</sup>

GDG textile/Upholstery com	854,00
A	981,00
B	1034,00
C	1106,00
D	1214,00
E	1315,00
F	1454,00
Leather 1	1511,00
Additional: removable fabric covers	104,00

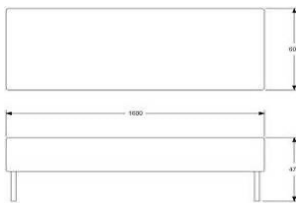

### ONE AIR SEAT 1600

Height 450 mm  
 Depth 600 mm  
 Width 1600 mm  
 Fabric 2,3 m  
 Weight 33 kg  
 Volume 0,50 m<sup>3</sup>

GDG textile/Upholstery com	1046,00
A	1203,00
B	1266,00
C	1353,00
D	1485,00
E	1608,00
F	1776,00
Leather 1	1832,00
Additional: removable fabric covers	106,00





## ONE AIR SEAT 2400

Height 450 mm  
 Depth 600 mm  
 Width 2400 mm  
 Fabric 3,1 m  
 Weight 50 kg  
 Volume 0,73 m<sup>3</sup>

GDG textile/Upholstery com	1454,00
A	1661,00
B	1746,00
C	1862,00
D	2041,00
E	2204,00
F	2433,00
Leather 1	2525,00
Additional: removable fabric covers	129,00

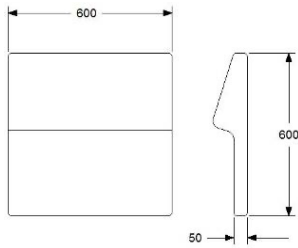

## ONE AIR CAFÉ BACK 600

Height 600/820 mm  
 Depth 50/130 mm  
 Width 600 mm  
 Fabric 0,8 m  
 Weight 19 kg  
 Volume 0,16 m<sup>3</sup>

GDG textile/Upholstery com	383,00
A	436,00
B	457,00
C	487,00
D	532,00
E	574,00
F	633,00
Leather 1	712,00
Additional: gap 20 mm between seat and backrest	11,00



## ONE AIR CAFÉ BACK 1200

Height 600/820 mm  
 Depth 50/130 mm  
 Width 1200 mm  
 Fabric 1,4 m  
 Weight 27 kg  
 Volume 0,22 m<sup>3</sup>

GDG textile/Upholstery com	478,00
A	571,00
B	609,00
C	661,00
D	744,00
E	816,00
F	920,00
Leather 1	967,00
Additional: gap 20 mm between seat and backrest	15,00



## ONE AIR CAFÉ BACK 1600

Height 600/820 mm incl legs  
 Depth 50/130 mm  
 Width 1600 mm  
 Fabric 1,8 m  
 Weight 30 kg  
 Volume 0,18 m<sup>3</sup>

GDG textile/Upholstery com	614,00
A	731,00
B	783,00
C	850,00
D	953,00
E	1048,00
F	1182,00
Leather 1	1231,00
Additional: gap 20 mm between seat and backrest	15,00



## ONE AIR CAFÉ BACK 2400

Height 600/820 mm incl legs  
 Depth 50/130 mm  
 Width 2400 mm  
 Fabric 2,7 m  
 Weight 37 kg  
 Volume 0,7 m<sup>3</sup>

GDG textile/Upholstery com	849,00
A	1027,00
B	1102,00
C	1206,00
D	1359,00
E	1502,00
F	1703,00
Leather 1	1763,00
Additional: gap 20 mm between seat and backrest	18,00

## ONE AIR CAFÉ BACK INNER CORNER FOR MOUNTING ON SEAT

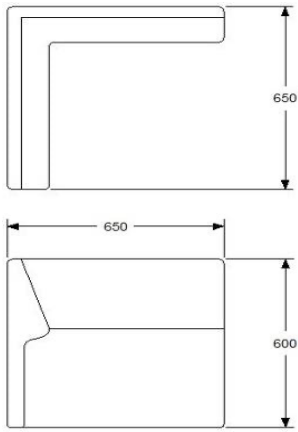

Height	600/820 mm incl legs
Depth	650 mm
Width	650 mm
Fabric	1,6 m
Weight	28 kg
Volume	0,55 m <sup>3</sup>

GDG textile/Upholstery com	674,00
A	779,00
B	821,00
C	883,00
D	975,00
E	1059,00
F	1177,00
Leather 1	1388,00

Additional distance 20 mm between seat and back 5,00  
Note back 670x670

## ONE AIR WALL 690

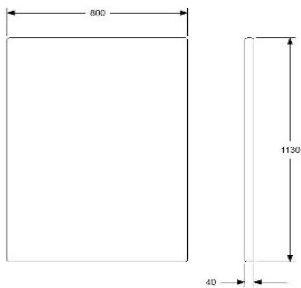

Height	1130 mm (1350 mounted on sofa)
Depth	40 mm
Width	690 mm
Fabric	1,4 m
Weight	15 kg
Volume	0,05 m <sup>3</sup>

GDG textile/Upholstery com	418,00
A	474,00
B	513,00
C	566,00
D	649,00
E	723,00
F	832,00

## ONE AIR WALL 600

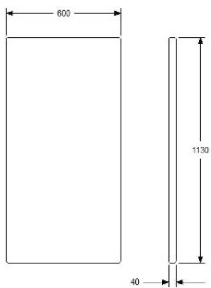

Height	1130 mm (1350 mounted on sofa)
Depth	40 mm
Width	600 mm
Fabric	1,4 m,
Weight	15 kg
Volume	0,05 m <sup>3</sup>

GDG textile/Upholstery com	418,00
A	474,00
B	513,00
C	566,00
D	649,00
E	723,00
F	832,00

## ONE AIR WALL 650

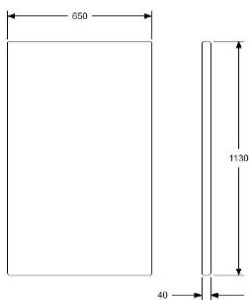

Height	1130 mm (1350 mounted on sofa)
Depth	40 mm
Width	650 mm
Fabric	1,4 m
Weight	15 kg
Volume	0,05 m <sup>3</sup>

GDG textile/Upholstery com	418,00
A	474,00
B	513,00
C	566,00
D	649,00
E	723,00
F	832,00

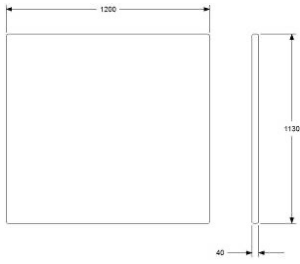

## ONE AIR WALL 1200

Height	1130 mm (1350 mounted on sofa)
Depth	40 mm
Width	1200 mm
Fabric	2,6 m
Weight	35 kg
Volume	0,14 m <sup>3</sup>

GDG textile/Upholstery com	518,00
A	647,00
B	718,00
C	818,00
D	945,00
E	1082,00
F	1311,00

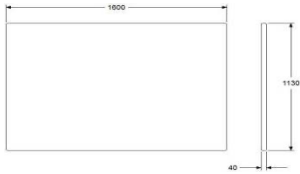

## ONE AIR WALL 1600

Height	1130 mm (1350 mounted on sofa)
Depth	40 mm
Width	1600 mm
Fabric	3,4 m
Weight	40 kg
Volume	0,14 m <sup>3</sup>

GDG textile/Upholstery com	566,00
A	745,00
B	841,00
C	973,00
D	1173,00
E	1357,00
F	1615,00

## LEG FOR A WALL WHEN PLACING OUTSIDE THE SOFA

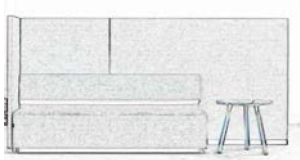

Black lacquered

Height	220 mm
--------	--------

87,00

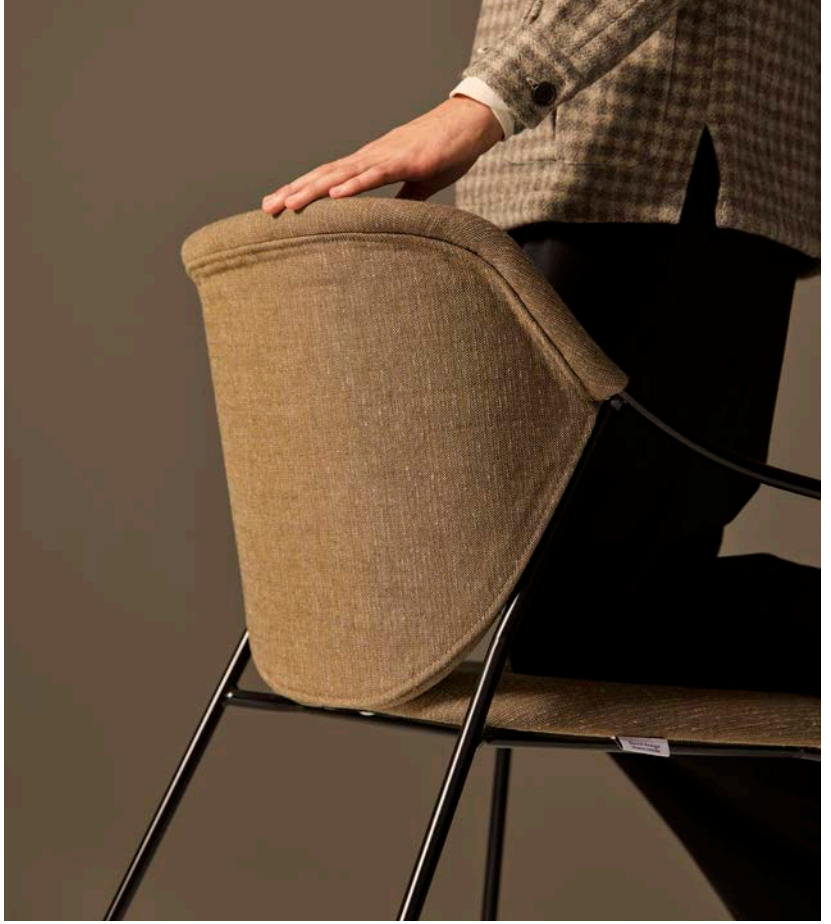
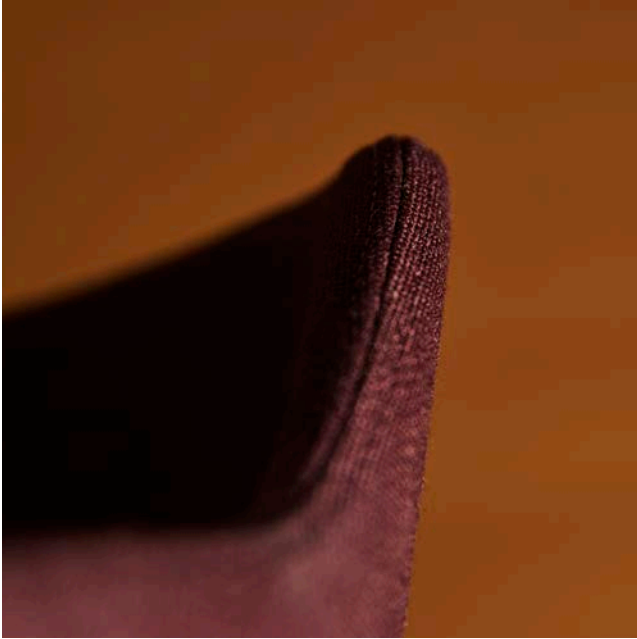

## OPTIONAL TEXTILES FOR PRODUCTS FROM DAVID DESIGN

All fabric specifications are based on a width of 140 cm. Our categories for fabrics and leather are:

GDG Textile	GABRIEL: CAMIRA: NEVOTEX:	MICA RIVET LIDO, LIDO TREND, SLOPE
CAT. A.	CAMIRA: DEPLOEG: GABRIEL: NEVOTEX: ROMO: SVENSSON: JÖRGENSEN	ERA, MAIN LINE FLAX, XTREME, X2 STONER, STRAND BOND, CURA, FOCUS, FOCUS MELANGE, MEDLEY, STEP, STEP MELANGE EROS, GRACE, IMOLA, POD, SELECT, STELLA, VIGGO LASER (EJ LASER FR) EASY, SEMI, TONE SILVERTEXT, VALENCIA
CAT. B.	BOGESUND: CAMIRA: GABRIEL: GUDBRANDSDALEN: JÖRGENSEN: KVADRAT: NEVOTEX: ROMO: SVENSSON: VESCO:	LIV BLAZER. HALCYON ASPEN-BLOSSOM-CEDAR, SYNERGY CRISP, EUROPOST, FAME, GO CHECK, SELECT BARDAL, HEIDAL, ROMSDAL EVIDA FLOYD, REMIX HIGHLAND VINTAGE PU, ICON, JAZZ, LINTEX, MARGRETHE, NOWA, OXIDON, UNITED, VEGAS ATLANTIS FR EASY CLEAN, CALVIA EASY CLEAN, CRUSH, LASER FR, SMOOTH, WAVE ALLY, HARPER, HELLO, KHAKI, MACRO, MINGEL, STEP, URBAN ARROW, AVON, CREEK, CYPRUS, DALMA, FURKA PLUS, JEMO, LEONE PLUS, MALTA, SAMAR, VINYL UPHOLSTERY
CAT. C.	BOGESUND: CAMIRA FABRICS: GABRIEL:  JÖRGENSEN: KVADRAT: MAHARAM: NEVOTEX: NYA NORDISKA: ROMO: SVENSSON: VESCO:	SHIMMER CRAGGAN FLAX, HEMP, SILK, YOREDALE BREEZE FUSION, CAPTURE, CONNECT, CRISS CROSS, FAME HYBRID, GAJA CLASSIC , GAJA C2C, NOMA, PASSION, RONDO, SWING  PUXX ATLAS, REVIVE MESSENGER4, MERIT BARNUM, BLUES, ENERGY, FUNK, ILLUSION, LAZY, POP, WOOLY CORD FLECK, LEAF, RUSKIN BALANCE, RAMI, RAMI PLUS, POPPY, VELVET ACTON, HARDIN, LAMU, LANI, LINDAU, NORFOLK, SCOTT, WILSON, WOLIN
CAT D.	ALMEDAHL: BUTE: CAMIRA GABRIEL: KVADRAT:  NEVOTEX: ROMO: SVENSSON: VESCO:	GRID, MOOR, TARTAN TWEED SYNERGY QUILT, LUNA2, MOOD CANVAS, CLARA, DIVINA 3, DIVINA MELANGE 3, DIVINA MD, FIELD, FIORD, FOSS, HALLINGDAL 65, MEMORY, RECHECK, RE-WOOL, RIME, STEELCUT 2, STEELCUT TRIO 3, TONICA2, TONUS 4  RITZ MAGMA, FLOW CODY, DEBUT AUCKLAND, FOSTER, FUGA, GAMMUT, HESTAN, NORFOLK, ROLLA
CAT E.	GABRIEL: KVADRAT: ROMO: NEVOTEX: VESCO:	COMFORT, MORPH CODA 2, LILA, MOLLY, SAVANNA, TONICA MIRROR, PENDANT VINTAGE BURTON, NOSS, PONZA
CAT F:	KVADRAT: GABRIEL:	BALDER, DROP, RAAS, RAZZLE DAZZLE, SPRINKLES, SUNNIVA SAVOY
Leather 1	ELMO LEATHER: SÖRENSEN:	ELMONORDIC, ELMOSOFT. ULTRA
Leather 2	SÖRENSEN:	DUNES, SAVANNE, TRIUMPH

All categories are without pattern matching. Please contact us for price/category if pattern matching is desired.  
Customer-ordered fabrics should be sent to: David Design, Rönneåsgatan 5b, 523 38 Ulricehamn."

# GOTESSONS 2025

For pictures, drawings, movies and other information,  
see [www.gotessons.com](http://www.gotessons.com).

## INFORMATION

**Delivery time:** In stock, dispatch 2 - 5 days

Delivery 4 - 6 weeks

For larger orders or special delivery, information will be sent separately. We reserve the right of longer delivery times for some products. For special colours, please ask for a quote.

**Terms of delivery:** According to agreement.

**Terms of payment:** According to agreement. Excl. VAT.

**Price adjustment:** We reserve the right to adjust prices.

**Transport damage:** If the packaging arrives damaged, report directly to the transport company and note this on the delivery sheet when signing. We reserve the right to deny damage claims if this is not done.

**Claims:** Any claims should be made to Gotessons within 7 days from reception of goods, including proof of picture. Gotessons must approve returns in advance. Returns due to mistakes in the order caused by customer will be credited by 80% of the value of the invoiced product. Products must be returned in the original packaging. Freight costs will be paid by the customer. Please note, this does not apply to customized or textile products, no returns can be accepted.

**Guarantee:** 2 years (applies to seats with recommended fabrics.)  
On Nordic Ecolabelled products, the warranty period is 5 years.



KVALITET ISO 9001:2015  
och MILJÖ ISO 14001:2015

Our policy is to continuously improve our products and performance. The environment is an integral part of all our business operations, we aim to be sustainable in all meanings of the word.

## acoustic facts

Swedish standard approved SS 25269. See [acousticfacts.com](http://acousticfacts.com).



Gotessons products are also available on:  
pCon.planner is a professional and free 3D design software. You'll be able to create complex projects in a very simple way. No matter if you are an interior designer, a facility manager or a retailer you'll find pCon.planner an innovative and powerful work tool.  
See [www.easterngraphics.com](http://www.easterngraphics.com)

© Copyright. Products from Götessons Industri AB, Sweden. [www.gotessons.com](http://www.gotessons.com).

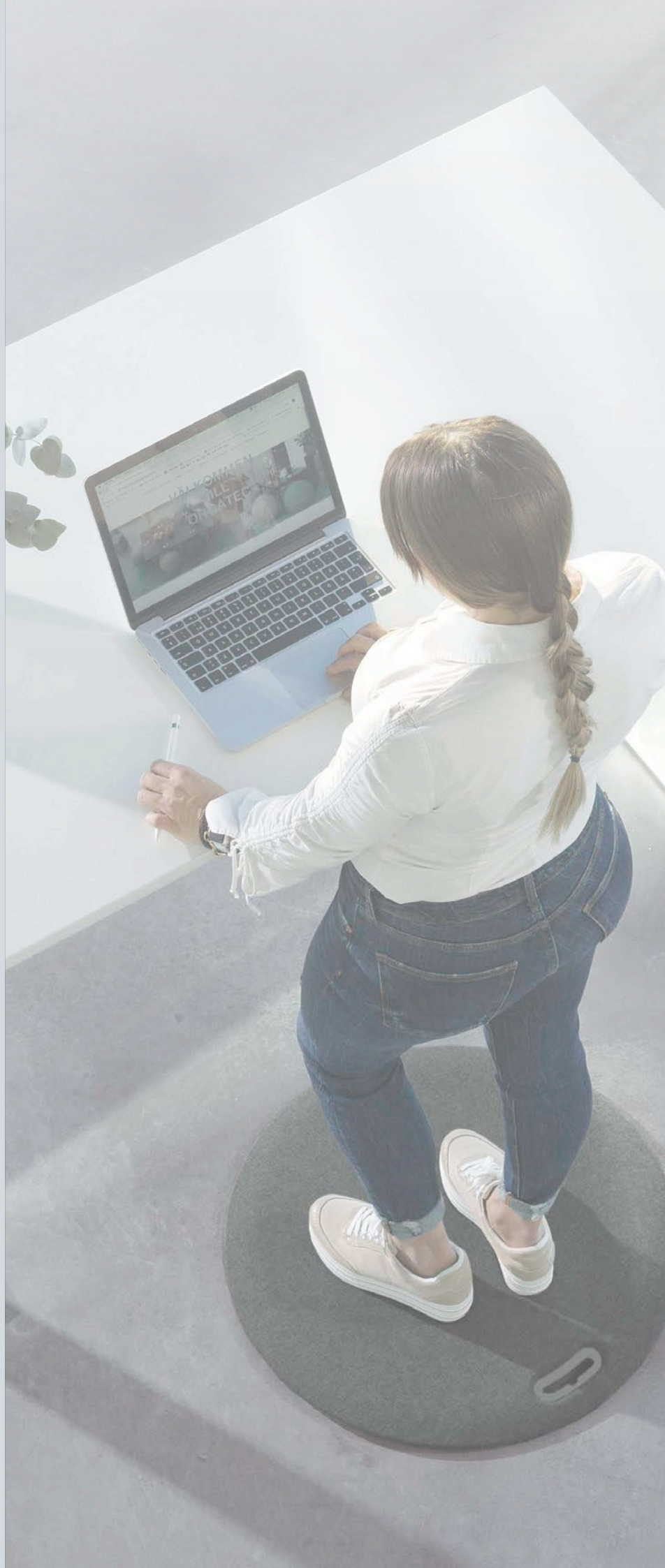

# PRODUCT INDEX A-Z

Delivery time:

⓪ 2-5 days

Ⓢ 4-6 weeks

In stock, dispatch 2 - 5 days

Delivery 4 - 6 weeks

For larger orders or special delivery, information will be sent separately. We reserve the right of longer delivery times for some products. For special colours, please ask for a quote.

<u>Name</u>	<u>Page</u>	<u>Del.</u>	<u>Name</u>	<u>Page</u>	<u>Del.</u>	<u>Name</u>	<u>Page</u>	<u>Del.</u>
A30 Light	51+197	L	Junction box	220	L	ScreenIT A30/A40 floor screen	62-66	B
Accessories Desk	52-59	L	Landscape	125	B	ScreenIT A40	33	B
AddOn	100-101	B	Laptop box	215	L	ScreenIT A40 desk screen with rail	40-41	B
Anyway CPU Holder	217	L	Leafpanel	173	L	ScreenIT AT40/Above Desk	36	B
Backrest	77	B	Leca	185	L	ScreenIT Plexi desk screen	37	B
Benches	158	B	Level	70-71	B	ScreenIT Standard desk screen	40	B
Bi-Box	229	L	Linjé 4Way Toolbar	53	L	ScreenIT Wardrobe	140	B
Bi-Lid	230	L	Link Ceiling	96	L	Scribble collection	84-85	B+L
Bright lamp	201	L	Link wall	120	B	Seasonal bouquet	171	L
BringIT	144+215	L	Lod lamella curtain	105	B	SetUpIT	213	L
Bubble - mat	165	L	Look	48+145	L	Sign	140	L
Cable Care cable holder	223	L	Metal plate for reversed desk edge	205	L	Silent Express desk screen	42	L
Cable Collector	224	L	Mount	28-31	L	Silent Pendant Lamp	200	L
Cable Grommets	225	L	Moving Wall	142-143	B	Simple Rest	167	L
Cable holder for conf. Table	222	L	Nivå tak ceiling absorbent	116	B	Sit Around	157	B
Cables	236-237	L	Nivå wall absorbent	134	B	Sketch writing board	88-89	B
Casa	65-69	B	No Pocket Table	157	L	Sketch 'n Pin	86-87	B
Chair pad	167	L	Noon lamp	195	L	Skiffer	185	L
Circle saw for cable grommet	225	L	Off The Grid	114	L	Sky	110-111	B
Clamp Design	97+121	L	Office Ballz	159	B	Slicepanel	173	L
Cobogo	112-113	L	Office Nap	161	B	SMS-Box	158	B
Collage wall/notice board	93	B	Office Power Clamp	235	L	Sofa Silent Group	81	B
Complete set	219	L	Peak desk screen booth	38	B	Sound Off ceiling absorbent	115	B
CPU holder 1	217	L	Pen tray Halfmoon	214	L	Sound Off letters	135	B
Cubism	128	L	Pendula	108-109	B	Sound Off wall absorbent	129	B
D-Zine	206-207	L	Piece of cake	156	B	Stand CPU holder	217	L
D-Zine Toolbar	53	L	Plant Divider	178	B	Storyboard wall/notice board	92	B
David design	238-269	B+L	Plant/Plain-panel	174-175	L	SwingIT CPU holder	217	L
Divido	106-107	B	PlantPanel Slice	124+	L	Table Top Slim	231	L
Dot StandzOn	164	L	Plants	180-187	L	Tell-Us wall absorbent	135	B
Double bracket for arms	207	L	Plexitop for screen	50	B	Textile box	144	L
Effekt wall/ceiling absorbent	98+117	B	Pocket	54+145	L	The Hut Collection	72-79	B
Floor protection	166	L	Pocket Table	157	L	The Lightning	198-199	L
Floor/wall cable collector alum+TPE	214	L	Pots	188-191	L	Tiles EcoSUND	102-103	B
Flora panel	123+170	L	Power Boxen	232	L	Tiles Tracks ceiling	99	L
FoldIT Basic Felt	43	B	Power Grommet	233	L	Tiles Tracks wall	122	L
Foot support	165	L	Power Inlay	229	L	Time Out	80	B
Freewall	52	L	Powerport	228	B	Toolbar Light	51+197	L
Funkia lamp	196	L	Print	130-133	B	Tulip/Tulip Toolbar	51	L
G-49 & G-79 cable holder	223	L	Pull-out pen drawer with lock	215	L	TurnIT CPU holder	216	L
G-clips	219	L	Quick cable holder	223	L	TwistIT	216	L
G-Power Qi	235	L	Re TurnIT +	210-212	B	V4 monitor arm	205	L
GST 18 connection	230	L	RomboPlanter	153+177	B	Vertikal lamellgardin	105	B
Halfpipe cable holder	221	L	Romboset	154-155	B	VESA-adapter	207	L
Hang In There	141	L	Rombowork	152	B	Vienna	171	L
Hang On	161	B	Sandy	148-151	B	Whiteboard	92	L
Hang Over ceiling absorbent	116	B	ScreenIT A30 desk screen	34-38	B	Wood chips	185	L
Health & Care	24-27	B	ScreenIT A30 desk screen above desk	39	B	Woodland accessories	90-91	B
Honey wall absorbent	126-127	B	ScreenIT A30 desk screen booth	37	B	Woodlight	194	L
Hook	55+145	L	ScreenIT A30 desk screen Sidescreen	39	B	Woodstock wall absorbents	128	L
In The Grid	104	L	ScreenIT A30 Flexible	31	B	Yoga mat	164	L
iQSeat	160	B	ScreenIT A30 floor screen booth	66-67	B	ZAP	204	L
iQube	160	B	ScreenIT A30 The Rising	59	B	ZAP Toolbar 3	53	L
			ScreenIT A30 with magnets	28	B			



OFFICE | CONFERENCE | SCHOOL | HOTEL 2025

## GÖTESSONS

Gotessons with head office and distribution center in Ulricehamn, develops and markets products for office, conference, school and hotel workspaces. We offer ergonomic, functional and well designed turnkey solutions to more than 40 countries using our motto "From Workplace to Creative Space".

**Visit us at [gotessons.com](https://www.gotessons.com)**